

MURA205T3, MURA210T3

Preferred Devices

Surface Mount Ultrafast Power Rectifiers

Ideally suited for high voltage, high frequency rectification, or as free wheeling and protection diodes in surface mount applications where compact size and weight are critical to the system.

- Small Compact Surface Mountable Package with J-Bend Leads
- Rectangular Package for Automated Handling
- High Temperature Glass Passivated Junction
- Low Forward Voltage Drop (0.74 Volts Max @ 2.0 A, $T_J = 150^\circ\text{C}$)

Mechanical Characteristics:

- Case: Epoxy, Molded
- Weight: 70 mg (approximately)
- Finish: All External Surfaces Corrosion Resistant and Terminal Leads are Readily Solderable
- Lead and Mounting Surface Temperature for Soldering Purposes: 260°C Max. for 10 Seconds
- Shipped in 12 mm Tape and Reel, 5000 units per reel
- Polarity: Polarity Band Indicates Cathode Lead
- ESD Protection: Human Body Model > 4000 V (Class 3)
Machine Model > 400 V (Class C)
- Marking: U5A, U5B

MAXIMUM RATINGS

Rating	Symbol	Value	Unit
Peak Repetitive Reverse Voltage	V_{RRM}		V
Working Peak Reverse Voltage	V_{RWM}		
DC Blocking Voltage	V_R	50	
		100	
Average Rectified Forward Current	$I_{F(AV)}$		A
@ $T_L = 155^\circ\text{C}$		1.0	
@ $T_L = 135^\circ\text{C}$		2.0	
Non-Repetitive Peak Surge Current	I_{FSM}	50	A
(Surge Applied at Rated Load Conditions Halfwave, Single Phase, 60 Hz)			
Operating Junction Temperature Range	T_J	- 65 to +175	$^\circ\text{C}$



ON Semiconductor®

<http://onsemi.com>

ULTRAFAST RECTIFIERS 2 AMPERES 50-100 VOLTS



SMA
CASE 403D
PLASTIC

MARKING DIAGRAM

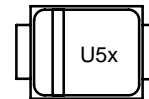

x = A (205T3)
B (210T3)

ORDERING INFORMATION

Device	Package	Shipping
MURA205T3	SMA	5000/Tape & Reel
MURA210T3	SMA	5000/Tape & Reel

Preferred devices are recommended choices for future use and best overall value.

MURA205T3, MURA210T3

THERMAL CHARACTERISTICS

Characteristic	Symbol	Max	Unit
Thermal Resistance, Junction to Lead (Note 1)	Ψ_{sJL} (Note 2)	24	$^{\circ}\text{C}/\text{W}$
Thermal Resistance, Junction to Ambient (Note 1)	$R_{\theta JA}$	216	

ELECTRICAL CHARACTERISTICS

Maximum Instantaneous Forward Voltage (Note 3) ($i_F = 2.0 \text{ A}$, $T_J = 25^{\circ}\text{C}$) ($i_F = 2.0 \text{ A}$, $T_J = 150^{\circ}\text{C}$)	V_F	0.94 0.74	Volts
Maximum Instantaneous Reverse Current (Note 3) (Rated dc Voltage, $T_J = 25^{\circ}\text{C}$) (Rated dc Voltage, $T_J = 150^{\circ}\text{C}$)	i_R	2.0 50	μA
Maximum Reverse Recovery Time ($i_F = 1.0 \text{ A}$, $di/dt = 50 \text{ A}/\mu\text{s}$)	t_{rr}	30	ns

1. Rating applies when surface mounted on the minimum pad size recommended, PC Board FR-4.
2. In compliance with JEDEC 51, these values (historically represented by $R_{\theta JL}$) are now referenced as Ψ_{sJL} .
3. Pulse Test: Pulse Width = 300 μs , Duty Cycle $\leq 2.0\%$.

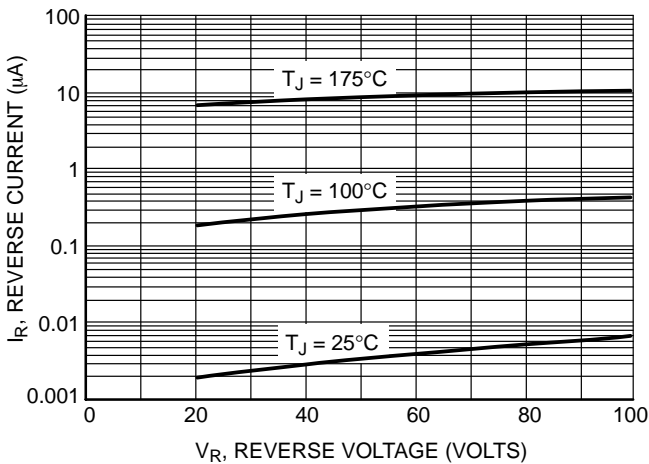

Figure 1. Typical Reverse Current

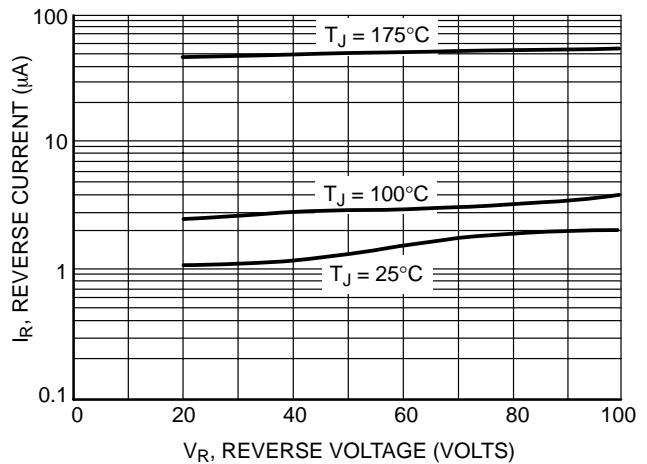

Figure 2. Maximum Reverse Current

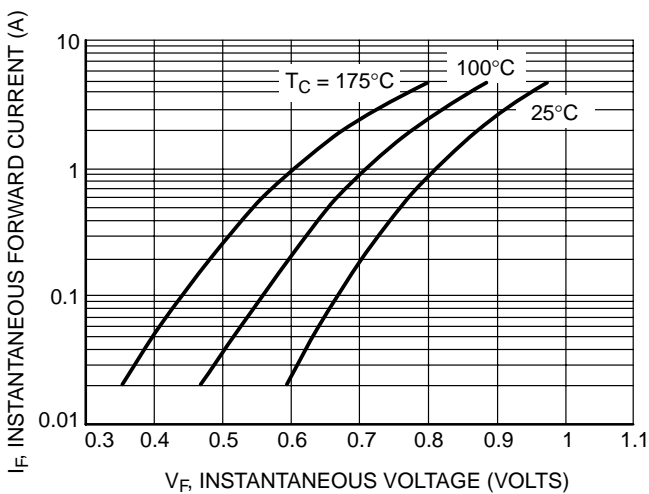

Figure 3. Typical Forward Voltage

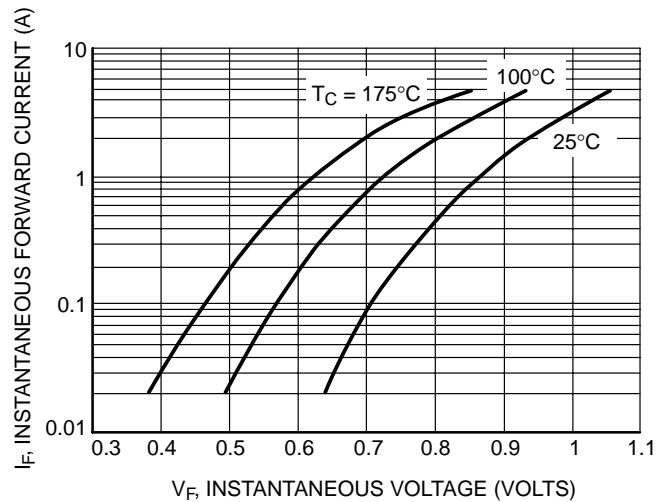

Figure 4. Maximum Forward Voltage

MURA205T3, MURA210T3

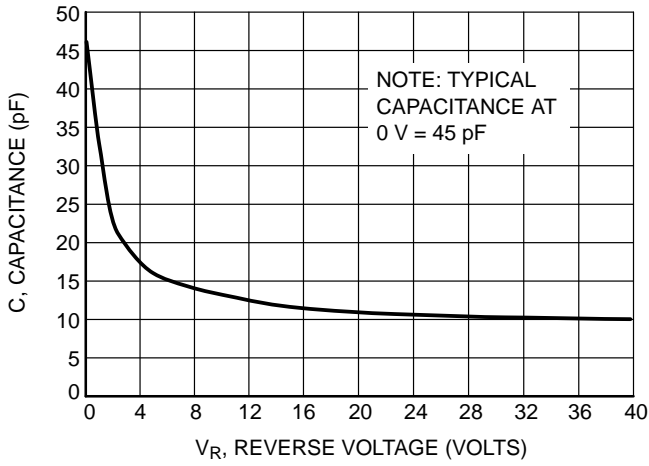

Figure 5. Typical Capacitance

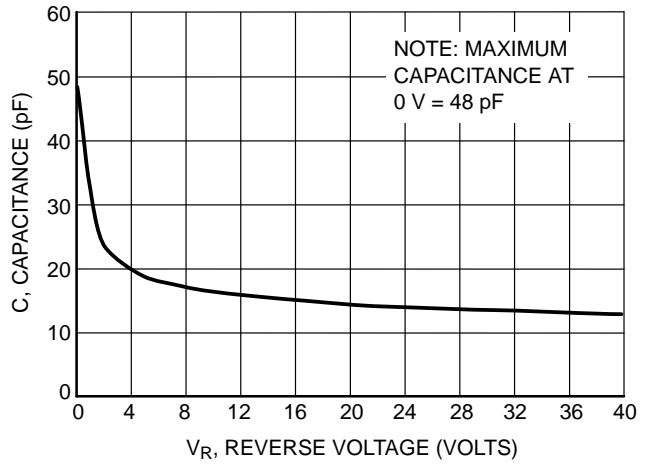

Figure 6. Maximum Capacitance

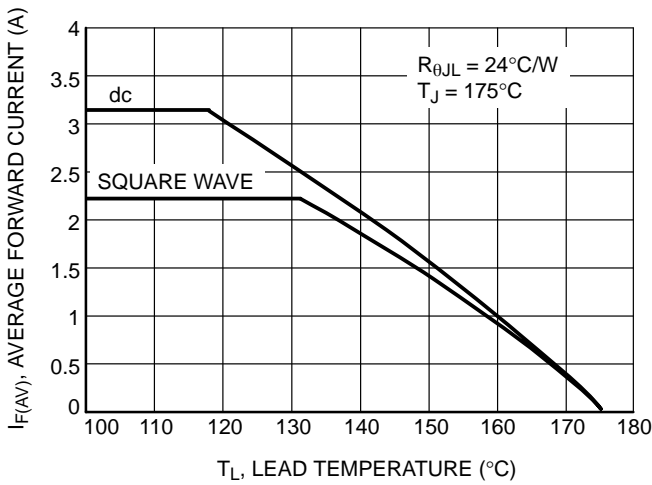

Figure 7. Current Derating, Lead

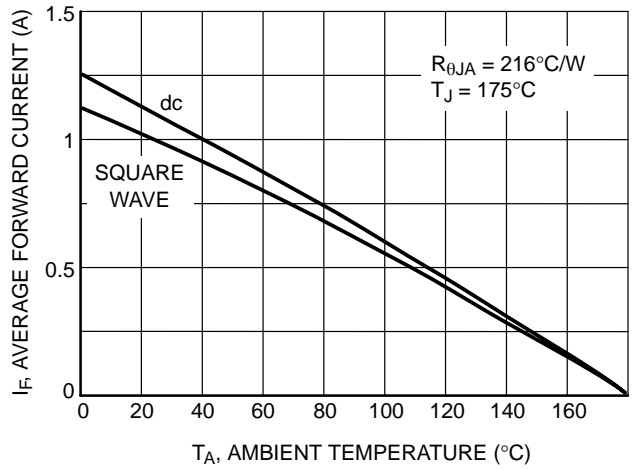

Figure 8. Current Derating, Ambient (FR-4 Board with Minimum Pad)

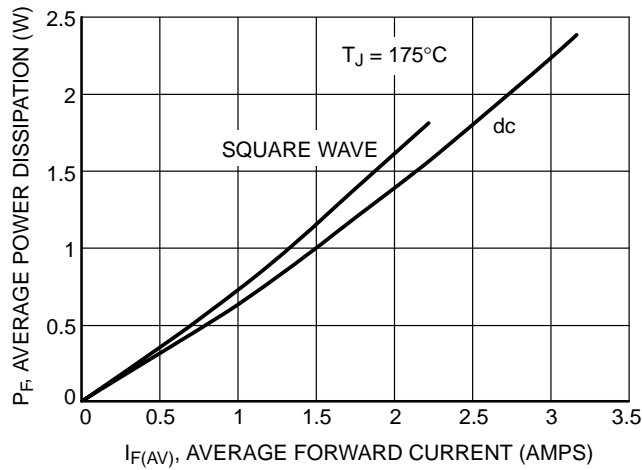
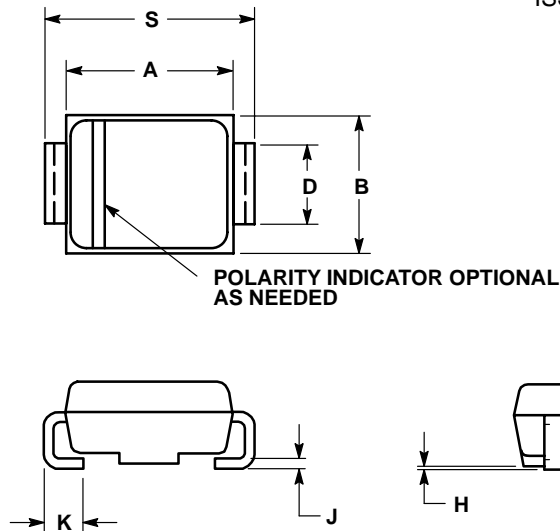

Figure 9. Power Dissipation

MURA205T3, MURA210T3

PACKAGE DIMENSIONS

SMA
CASE 403D-02
ISSUE A



- NOTES:
1. DIMENSIONING AND TOLERANCING PER ANSI Y14.5M, 1982.
 2. CONTROLLING DIMENSION: INCH.
 3. 403D-01 OBSOLETE, NEW STANDARD IS 403D-02.

DIM	INCHES		MILLIMETERS	
	MIN	MAX	MIN	MAX
A	0.160	0.180	4.06	4.57
B	0.090	0.115	2.29	2.92
C	0.075	0.095	1.91	2.41
D	0.050	0.064	1.27	1.63
H	0.002	0.006	0.05	0.15
J	0.006	0.016	0.15	0.41
K	0.030	0.060	0.76	1.52
S	0.190	0.220	4.83	5.59

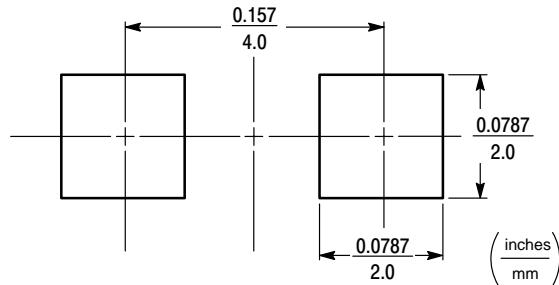

SMA FOOTPRINT

ON Semiconductor and  are registered trademarks of Semiconductor Components Industries, LLC (SCILLC). SCILLC reserves the right to make changes without further notice to any products herein. SCILLC makes no warranty, representation or guarantee regarding the suitability of its products for any particular purpose, nor does SCILLC assume any liability arising out of the application or use of any product or circuit, and specifically disclaims any and all liability, including without limitation special, consequential or incidental damages. "Typical" parameters which may be provided in SCILLC data sheets and/or specifications can and do vary in different applications and actual performance may vary over time. All operating parameters, including "Typicals" must be validated for each customer application by customer's technical experts. SCILLC does not convey any license under its patent rights nor the rights of others. SCILLC products are not designed, intended, or authorized for use as components in systems intended for surgical implant into the body, or other applications intended to support or sustain life, or for any other application in which the failure of the SCILLC product could create a situation where personal injury or death may occur. Should Buyer purchase or use SCILLC products for any such unintended or unauthorized application, Buyer shall indemnify and hold SCILLC and its officers, employees, subsidiaries, affiliates, and distributors harmless against all claims, costs, damages, and expenses, and reasonable attorney fees arising out of, directly or indirectly, any claim of personal injury or death associated with such unintended or unauthorized use, even if such claim alleges that SCILLC was negligent regarding the design or manufacture of the part. SCILLC is an Equal Opportunity/Affirmative Action Employer.

PUBLICATION ORDERING INFORMATION

Literature Fulfillment:

Literature Distribution Center for ON Semiconductor
P.O. Box 5163, Denver, Colorado 80217 USA
Phone: 303-675-2175 or 800-344-3860 Toll Free USA/Canada
Fax: 303-675-2176 or 800-344-3867 Toll Free USA/Canada
Email: ONlit@hibbertco.com

N. American Technical Support: 800-282-9855 Toll Free USA/Canada

JAPAN: ON Semiconductor, Japan Customer Focus Center
2-9-1 Kamimeguro, Meguro-ku, Tokyo, Japan 153-0051
Phone: 81-3-5773-3850
Email: r14525@onsemi.com

ON Semiconductor Website: <http://onsemi.com>

For additional information, please contact your local Sales Representative.