

SUPER BRIGHT T-1 3/4 (5 mm) LED LAMP - Water Clear

PACKAGE DIMENSIONS

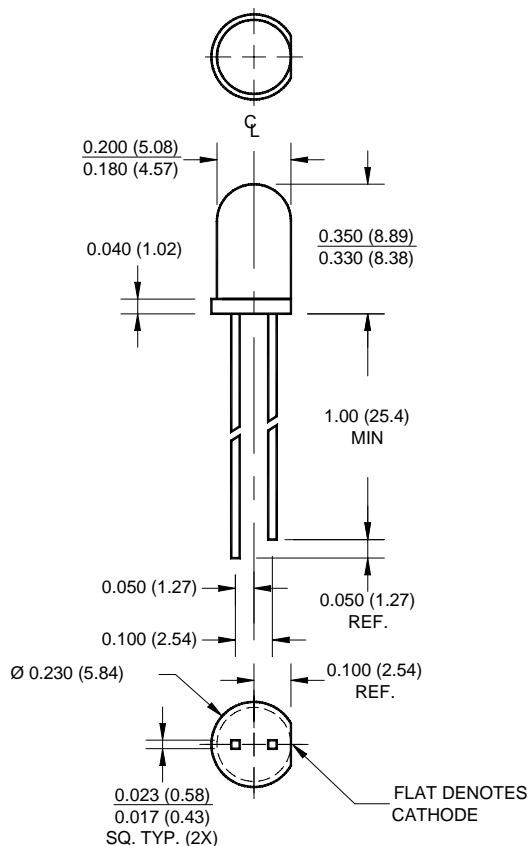

NOTES:

1. Dimensions for all drawings are in inches (mm).
2. Lead spacing is measured where the leads emerge from the package.
3. Protruded resin under the flange is 1.5 mm (0.059") max.

SUPER YELLOW
MV8303 MV8304
MV8305 MV8306

MV830X

FEATURES

- Popular T-1 3/4 package
- Super high brightness suitable for outdoor applications
- Solid state reliability
- Water clear optics
- Standard 100 mil. lead spacing

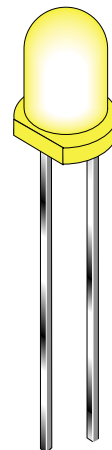

DESCRIPTION

This T-1 3/4 super bright LED has a moderate viewing angle of 20° for concentrated light output. The MV830X series is made with an AlInGaP LED that emits yellow light at 590 nm. It is encapsulated in a water clear epoxy lens package.

ABSOLUTE MAXIMUM RATINGS ($T_A = 25^\circ\text{C}$ unless otherwise specified)

Parameter	Symbol	Rating	Unit
Operating Temperature	T_{OPR}	-40 to +100	$^\circ\text{C}$
Storage Temperature	T_{STG}	-40 to +100	$^\circ\text{C}$
Lead Soldering Time	T_{SOL}	260 for 5 sec	$^\circ\text{C}$
Continuous Forward Current	I_F	30	mA
Peak Forward Current ($f = 1.0$ KHz, Duty Factor = 1/10)	I_F	160	mA
Reverse Voltage	V_R	5	V
Power Dissipation	P_D	85	mW

SUPER BRIGHT T-1 3/4 (5 mm)

LED LAMP - Water Clear

SUPER YELLOW
MV8303 MV8304
MV8305 MV8306

MV830X

ELECTRICAL / OPTICAL CHARACTERISTICS (T_A = 25°C)

Part Number	MV8303	MV8304	MV8305	MV8306	Condition
Luminous Intensity (mcd)					I _F = 20 mA
Minimum	630	1000	1600	2500	
Typical	940	1500	2400	3500	
Forward Voltage (V)					I _F = 20 mA
Maximum	2.8	2.8	2.8	2.8	
Typical	2.1	2.1	2.1	2.1	
Peak Wavelength (nm)	590	590	590	590	I _F = 20 mA
Spectral Line Half Width (nm)	15	15	15	15	I _F = 20 mA
Viewing Angle (°)	20	20	20	20	I _F = 20 mA

TYPICAL PERFORMANCE CURVES

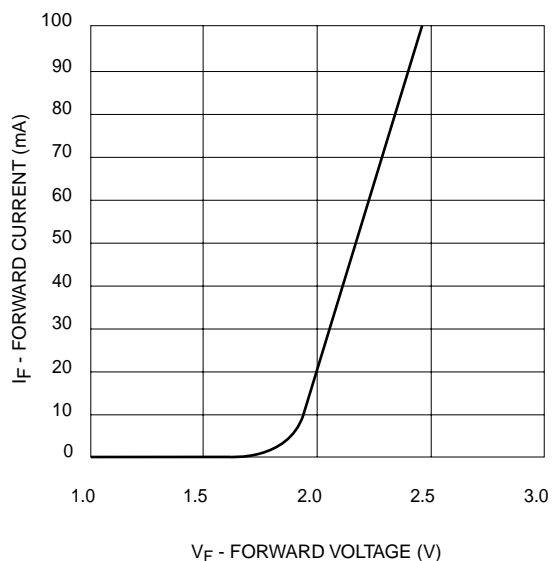

Fig. 1 Forward Current vs. Forward Voltage

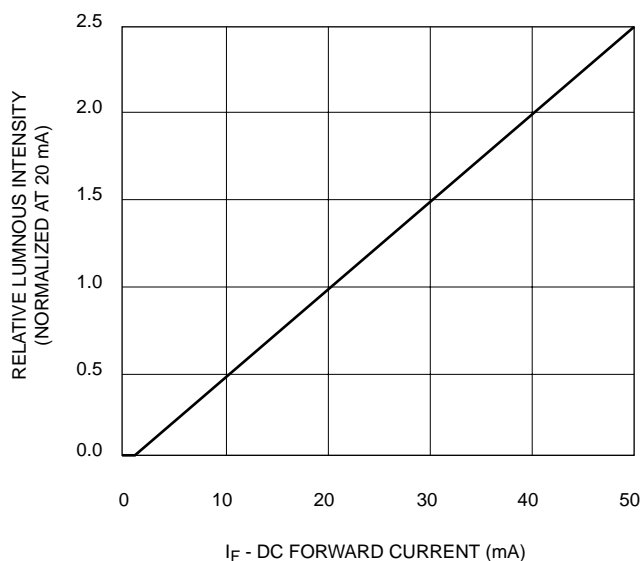

Fig. 2 Relative Luminous Intensity vs. DC Forward Current

SUPER BRIGHT T-1 3/4 (5 mm)

LED LAMP - Water Clear

SUPER YELLOW	MV830X
MV8303 MV8304	
MV8305 MV8306	

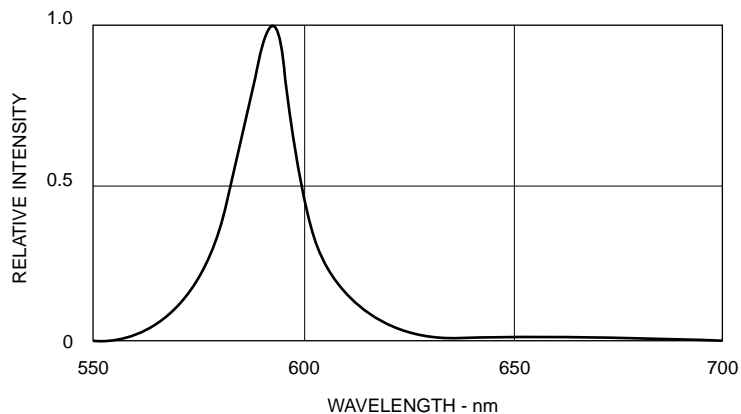

Fig. 3 Relative Intensity vs Peak Wavelength

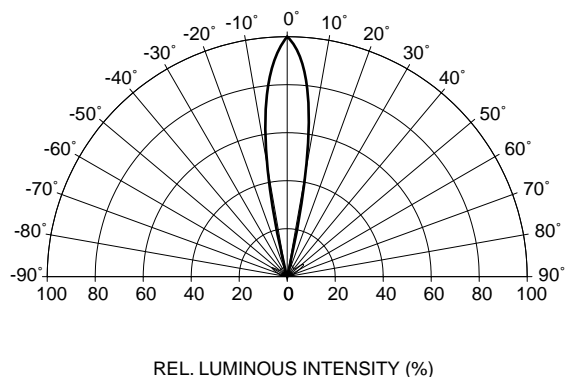

Fig. 4 Radiation Diagram

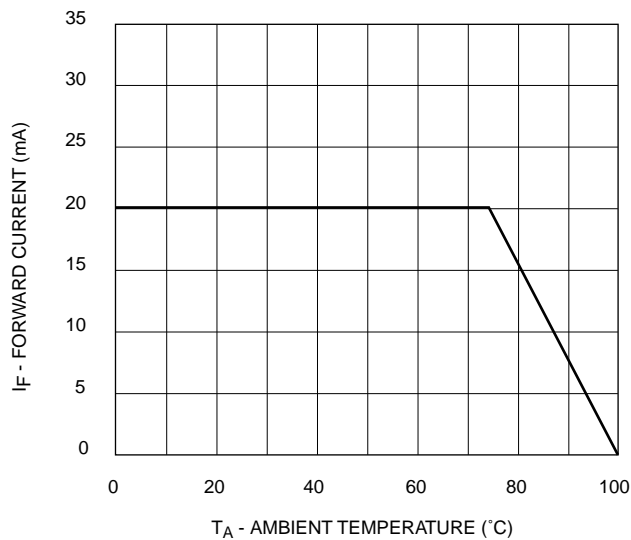

Fig. 5 Current Derating Curve