

NCP580

Ultra-Fast, Low Noise 120 mA CMOS LDO Regulator with Enable

The NCP580 series of low dropout regulators are designed for portable battery powered applications which require precise output voltage accuracy, low quiescent current, and high ripple rejection. These devices feature an enable function which lowers current consumption significantly and are offered in the small SC-82AB package.

A 2.2 μF ceramic capacitor or higher is the recommended value to be used with these devices on the output pin.

Features

- Ultra-Low Dropout Voltage of 150 mV at 100 mA
- Low Output Noise of 30 μV_{rms} without Noise Reduction Cap
- Excellent Line Regulation of 0.02%/V
- Excellent Load Regulation of 12 mV
- High Output Voltage Accuracy of $\pm 1.5\%$
- Low I_q Current of 90 μA
- Very Low Shutdown Current of 0.1 μA
- Excellent Power Supply Rejection Ratio of 70 dB at $f = 1.0$ kHz
- Wide Output Voltage Range of 1.5 V to 3.3 V
- Fold Back Protection Circuit
- Fast Dynamic Performance
- Low Temperature Drift Coefficient on the Output Voltage of ± 100 ppm/ $^{\circ}\text{C}$
- Input Voltage up to 6.5 V
- These are Pb-Free Devices

Typical Applications

- Portable Equipment
- Hand-Held Instrumentation
- Camcorders and Cameras

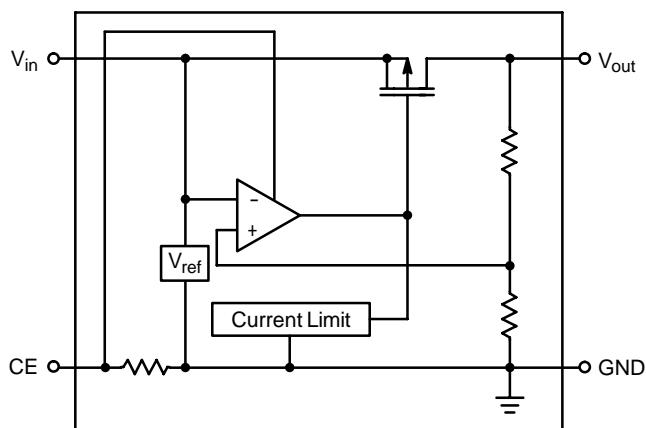

Figure 1. Simplified Block Diagram



ON Semiconductor®

<http://onsemi.com>

MARKING DIAGRAM

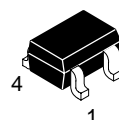

SC-82AB
SQ SUFFIX
CASE 419C

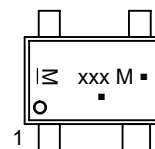

xxx = Device Code
M = Date Code*
▪ = Pb-Free Package
(Note: Microdot may be in either location)

*Date Code orientation and/or position may vary depending upon manufacturing location.

ORDERING INFORMATION

See detailed ordering and shipping information in the package dimensions section on page 8 of this data sheet.

NCP580

PIN FUNCTION DESCRIPTION

| Pin | Symbol | Description |
|-----|-----------|-----------------------------|
| 1 | V_{out} | Regulated output voltage. |
| 2 | GND | Power supply ground. |
| 3 | CE | Chip enable pin. |
| 4 | V_{in} | Power supply input voltage. |

MAXIMUM RATINGS

| Rating | Symbol | Value | Unit |
|--|-----------|------------------------|------|
| Input Voltage | V_{in} | 6.5 | V |
| Input Voltage (\overline{CE} or CE Pin) | V_{CE} | -0.3 to $V_{in} + 0.3$ | V |
| Output Voltage | V_{out} | -0.3 to $V_{in} + 0.3$ | V |
| Output Current | I_{out} | 140 | mA |
| Power Dissipation | P_D | 150 | mW |
| Operating Junction Temperature Range | T_J | -40 to +85 | °C |
| Storage Temperature Range | T_{stg} | -55 to +150 | °C |

Maximum ratings are those values beyond which device damage can occur. Maximum ratings applied to the device are individual stress limit values (not normal operating conditions) and are not valid simultaneously. If these limits are exceeded, device functional operation is not implied, damage may occur and reliability may be affected.

ELECTRICAL CHARACTERISTICS ($V_{in} = V_{out} + 1.0$ V, $T_A = 25^\circ\text{C}$, unless otherwise noted.)

| Characteristic | Symbol | Min | Typ | Max | Unit |
|---|----------------------------------|------------------------|------------------------------|------------------------------|---------------------|
| Input Voltage | V_{in} | 2.2 | - | 6.0 | V |
| Output Voltage ($I_{out} = 1.0$ mA to 30 mA) | V_{out} | $V_{out} \times 0.985$ | - | $V_{out} \times 1.015$ | V |
| Line Regulation ($I_{out} = 30$ mA) ($V_{out} + 0.5$ V $\leq V_{in} \leq 6.0$ V) ($V_{out} = 1.5$ V, 2.2 V $\leq V_{in} \leq 6.0$ V) | Reg _{line} | - | 0.02 | 0.10 | %/V |
| Load Regulation ($I_{out} = 1.0$ mA to 120 mA) | Reg _{load} | - | 12 | 40 | mV |
| Dropout Voltage ($I_{out} = 120$ mA) $V_{out} = 1.5$ V $V_{out} = 1.8$ V $V_{out} = 2.5$ V 2.8 V $\leq V_{out} \leq 3.3$ V | V_{DO} | - | 0.36 0.28 0.24 0.18 | 0.70 0.40 0.35 0.28 | V |
| Quiescent Current ($I_{out} = 0$ mA) | I_q | - | 90 | 160 | μA |
| Output Current | I_{out} | 120 | - | - | mA |
| Shutdown Current ($V_{in} = V_{CE}$) | I_{SD} | - | 0.1 | 1.0 | μA |
| Output Short Circuit Current ($V_{out} = 0$) | I_{lim} | - | 40 | - | mA |
| Ripple Rejection ($I_{out} = 30$ mA) $f = 1.0$ kHz ($V_{out} = 1.5$ V, $V_{in} - V_{out} = 1.2$ V) ($V_{out} \geq 2.5$ V, $V_{in} - V_{out} = 1.0$ V) | RR | - | 75 70 | - | dB |
| Enable Input Threshold Voltage High Low | $V_{th_{enh}}$ $V_{th_{enl}}$ | 1.5 0 | - - | V_{in} 0.3 | V |
| Output Noise Voltage (Bandwidth = 10 Hz to 100 kHz) | V_n | - | 30 | - | μV_{rms} |
| Output Voltage Temperature Coefficient ($I_{out} = 30$ mA, $-40^\circ\text{C} \leq T_A \leq 85^\circ\text{C}$) | $\Delta V_{out}/\Delta T$ | - | ± 100 | - | ppm/°C |

TYPICAL CHARACTERISTICS

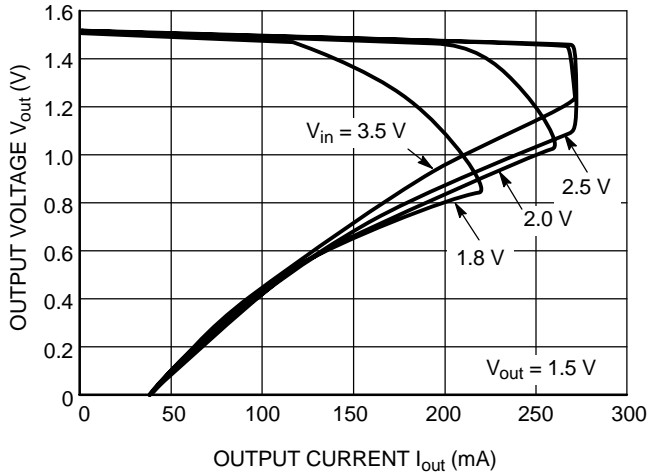

Figure 2. Output Voltage vs. Output Current

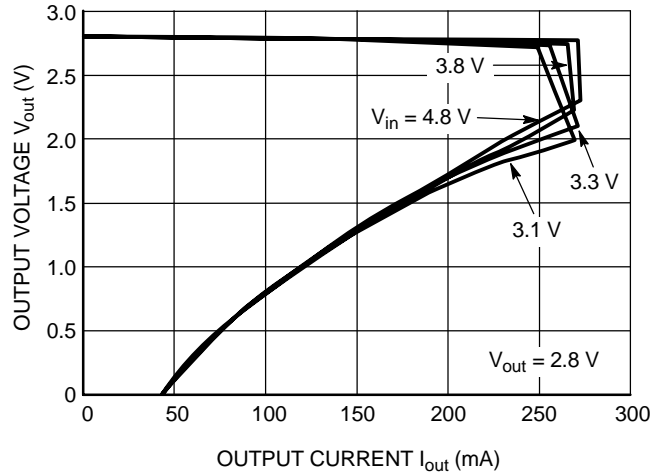

Figure 3. Output Voltage vs. Output Current

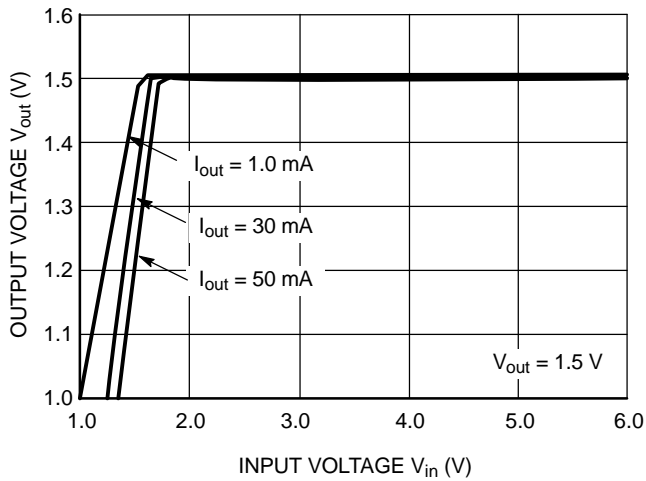

Figure 4. Output Voltage vs. Input Voltage

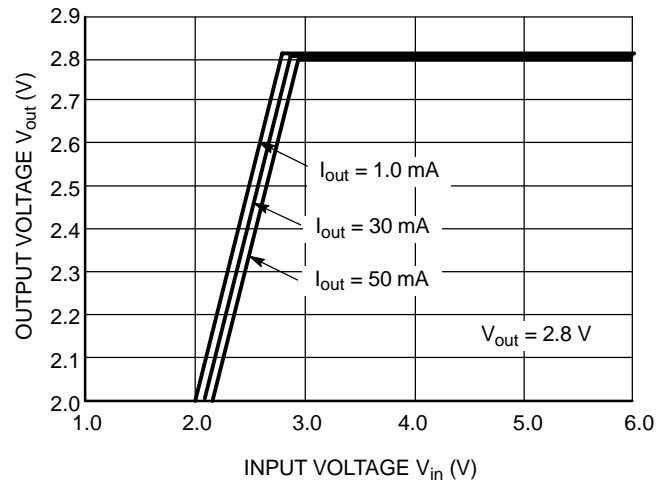

Figure 5. Output Voltage vs. Input Voltage

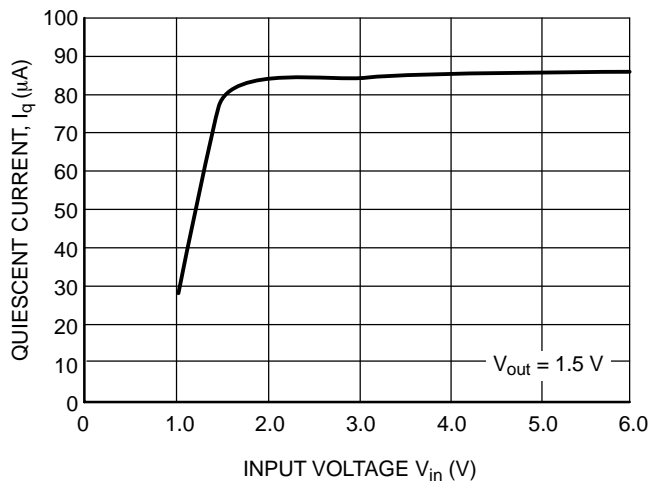

Figure 6. Quiescent Current vs. Input Voltage

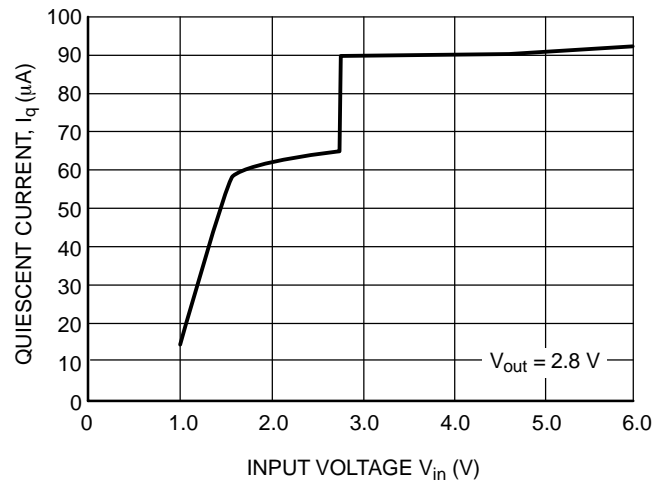

Figure 7. Quiescent Current vs. Input Voltage

NCP580

TYPICAL CHARACTERISTICS

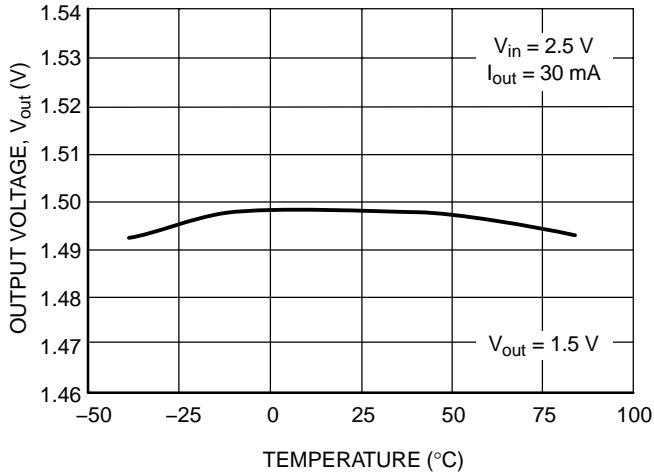

Figure 8. Output Voltage vs. Temperature

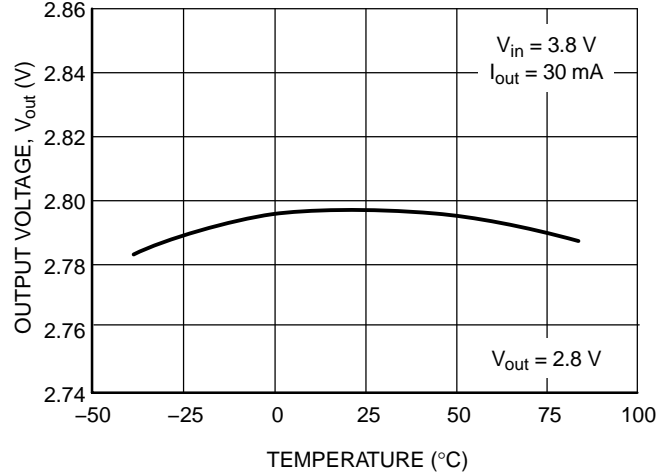

Figure 9. Output Voltage vs. Temperature

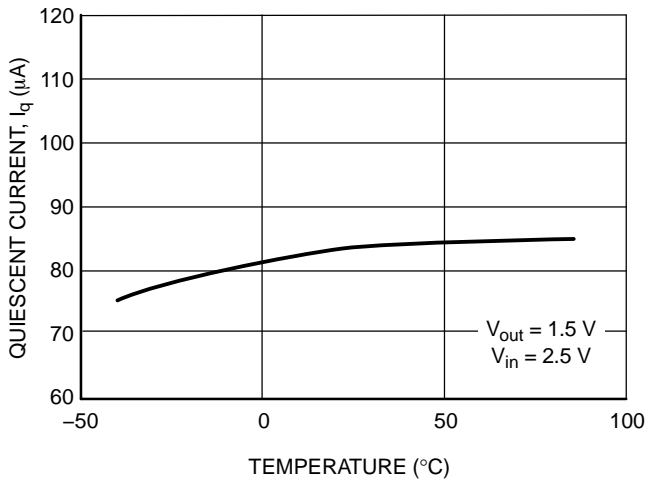

Figure 10. Quiescent Current vs. Temperature

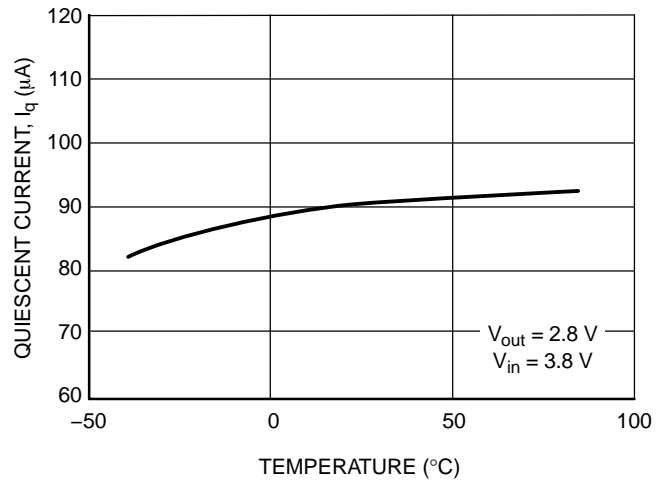

Figure 11. Quiescent Current vs. Temperature

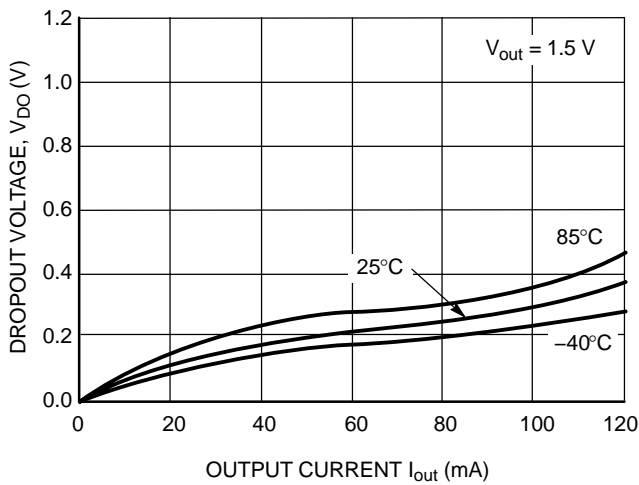

Figure 12. Dropout Voltage vs. Output Current

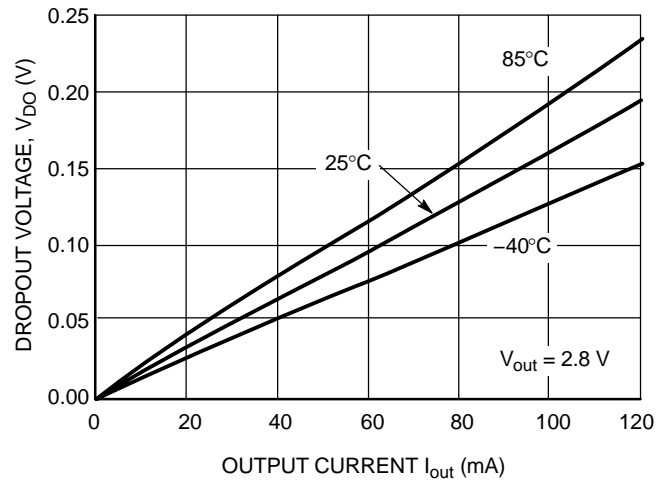

Figure 13. Dropout Voltage vs. Output Current

NCP580

TYPICAL CHARACTERISTICS

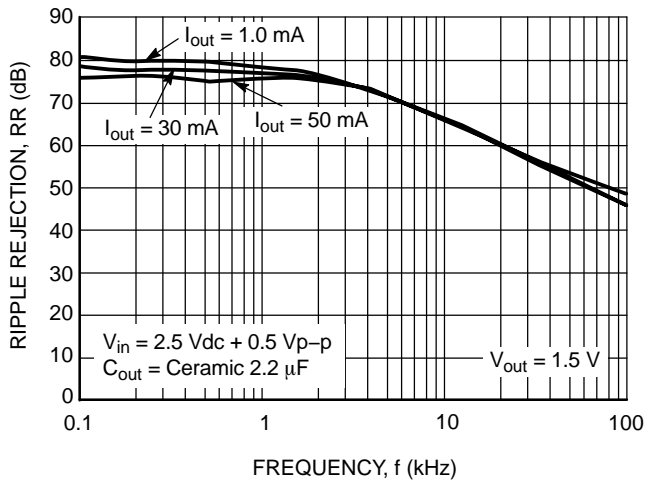

Figure 14. Ripple Rejection vs. Frequency

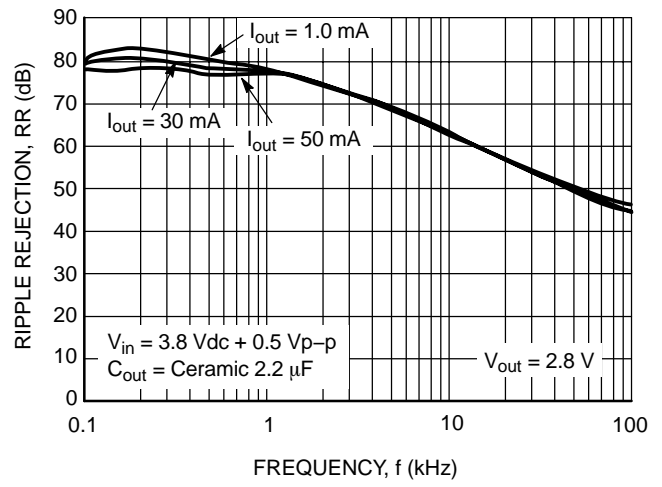

Figure 15. Ripple Rejection vs. Frequency

NCP580

TYPICAL CHARACTERISTICS

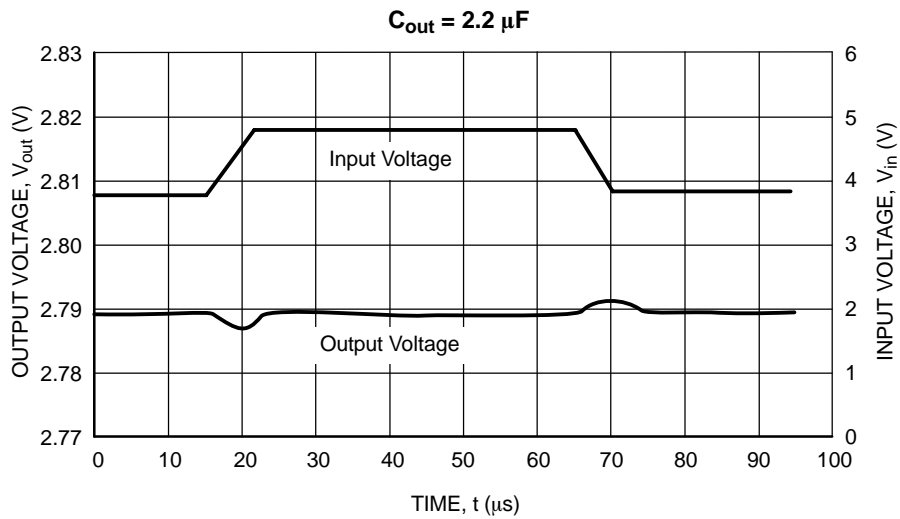
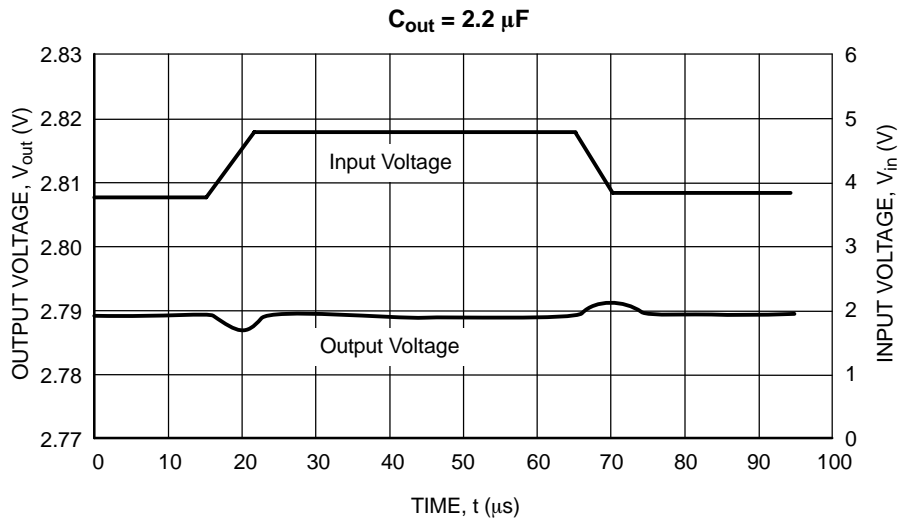
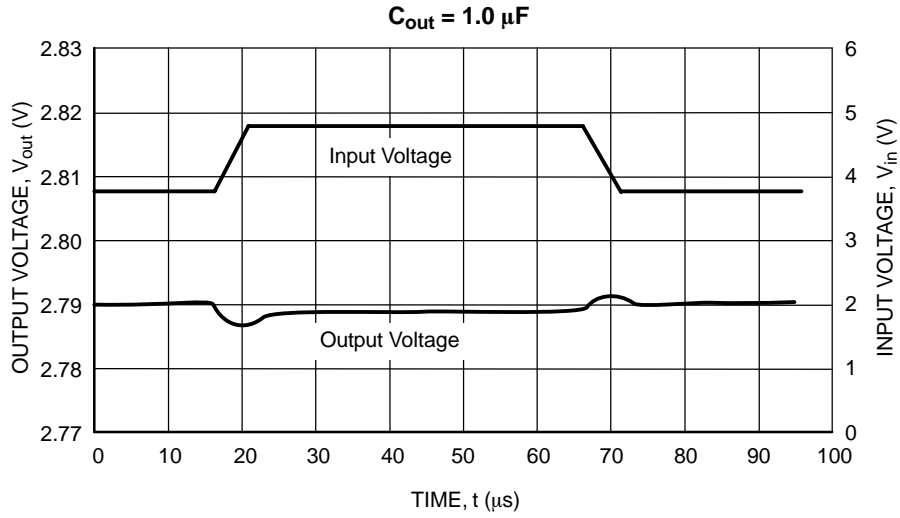

Figure 16. Input Transient Response
($V_{in} = 3.8 \text{ V to } 4.8 \text{ V}$, $I_{out} = 30 \text{ mA}$, $t_r = t_f = 5.0 \mu s$, $V_{out} = 2.8 \text{ V}$)

NCP580

TYPICAL CHARACTERISTICS

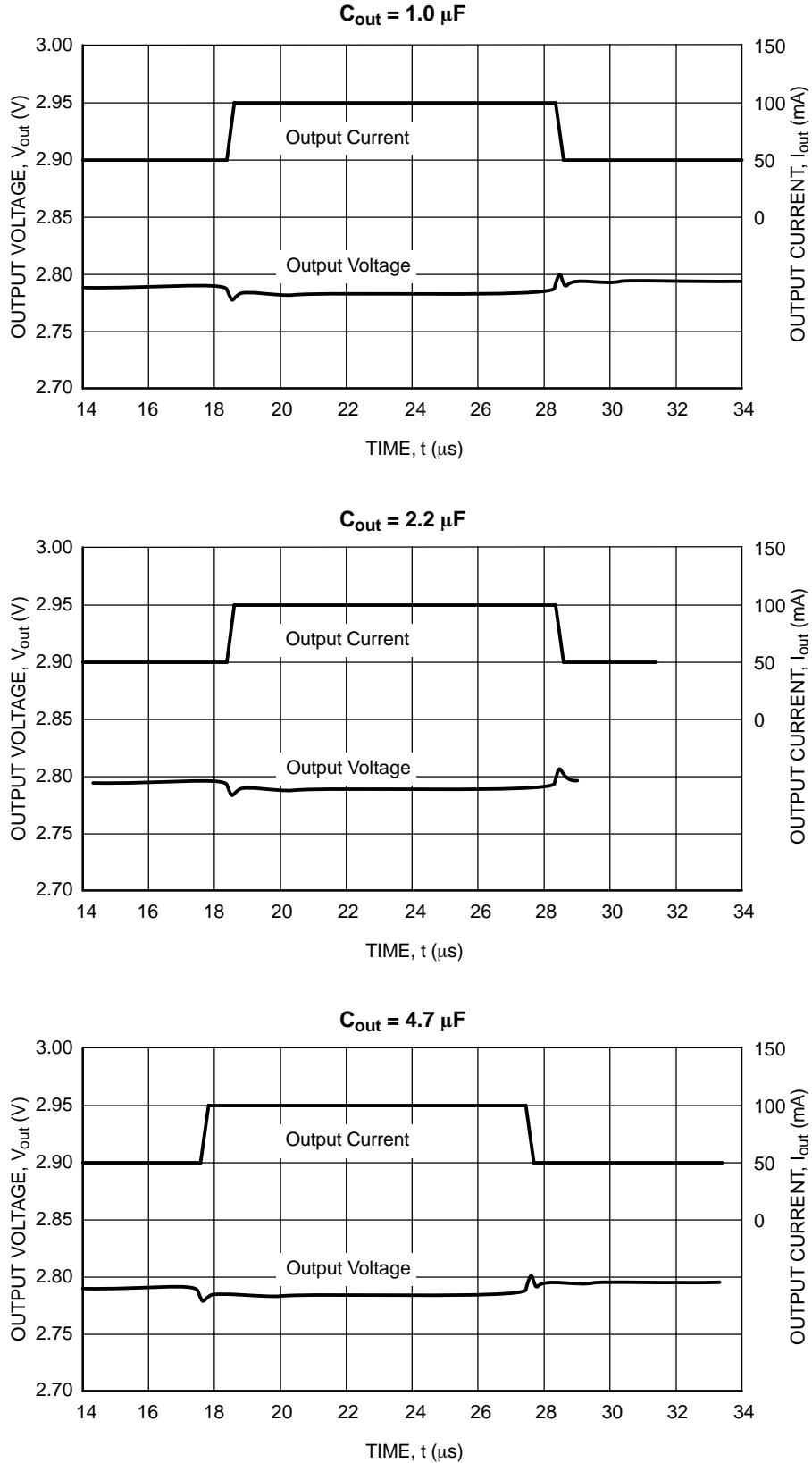

Figure 17. Load Transient Response
($V_{in} = 3.8 V$, $I_{out} = 50 mA$ to $100 mA$, $t_r = t_f = 5.0 \mu s$, $C_{in} = 1.0 \mu F$, $V_{out} = 2.8 V$)

NCP580

APPLICATION INFORMATION

Input Decoupling

A 1.0 μF ceramic capacitor is the recommended value to be connected between V_{in} and GND. For PCB layout considerations, the traces of V_{in} and GND should be sufficiently wide in order to minimize noise and prevent unstable operation.

Output Decoupling

It is best to use a 2.2 μF or higher capacitor value on the V_{out} pin. For better performance, select a capacitor with low Equivalent Series Resistance (ESR). For PCB layout considerations, place the output capacitor close to the output pin and keep the leads short as possible.

ORDERING INFORMATION

| Device | Output Type / Features | Nominal Output Voltage | Marking | Package | Shipping† |
|---------------|------------------------|------------------------|---------|----------------------|------------------|
| NCP580SQ15T1G | Active High | 1.5 | AF | SC-82AB (Pb-Free) | 3000 Tape & Reel |
| NCP580SQ18T1G | Active High | 1.8 | AK | SC-82AB (Pb-Free) | 3000 Tape & Reel |
| NCP580SQ25T1G | Active High | 2.5 | BF | SC-82AB (Pb-Free) | 3000 Tape & Reel |
| NCP580SQ28T1G | Active High | 2.8 | BJ | SC-82AB (Pb-Free) | 3000 Tape & Reel |
| NCP580SQ30T1G | Active High | 3.0 | CA | SC-82AB (Pb-Free) | 3000 Tape & Reel |
| NCP580SQ33T1G | Active High | 3.3 | CD | SC-82AB (Pb-Free) | 3000 Tape & Reel |

†For information on tape and reel specifications, including part orientation and tape sizes, please refer to our Tape and Reel Packaging Specification Brochure, BRD8011/D.

NCP580

PACKAGE DIMENSIONS

SC-82AB
SQ SUFFIX
CASE 419C-02
ISSUE D

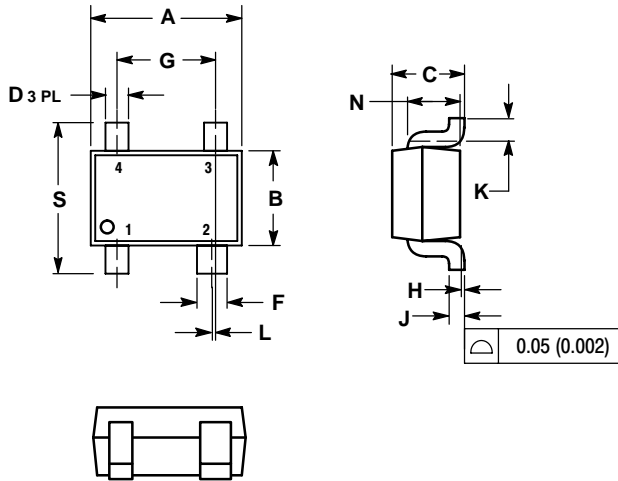

NOTES:

1. DIMENSIONING AND TOLERANCING PER ANSI Y14.5M, 1982.
2. CONTROLLING DIMENSION: MILLIMETER.
3. 419C-01 OBSOLETE. NEW STANDARD IS 419C-02.
4. DIMENSIONS A AND B DO NOT INCLUDE MOLD FLASH, PROTRUSIONS, OR GATE BURRS.

| DIM | MILLIMETERS | | INCHES | |
|-----|-------------|------|-----------|-------|
| | MIN | MAX | MIN | MAX |
| A | 1.8 | 2.2 | 0.071 | 0.087 |
| B | 1.15 | 1.35 | 0.045 | 0.053 |
| C | 0.8 | 1.1 | 0.031 | 0.043 |
| D | 0.2 | 0.4 | 0.008 | 0.016 |
| F | 0.3 | 0.5 | 0.012 | 0.020 |
| G | 1.1 | 1.5 | 0.043 | 0.059 |
| H | 0.0 | 0.1 | 0.000 | 0.004 |
| J | 0.10 | 0.26 | 0.004 | 0.010 |
| K | 0.1 | --- | 0.004 | --- |
| L | 0.05 BSC | | 0.002 BSC | |
| N | 0.2 REF | | 0.008 REF | |
| S | 1.8 | 2.4 | 0.07 | 0.09 |

SOLDERING FOOTPRINT*

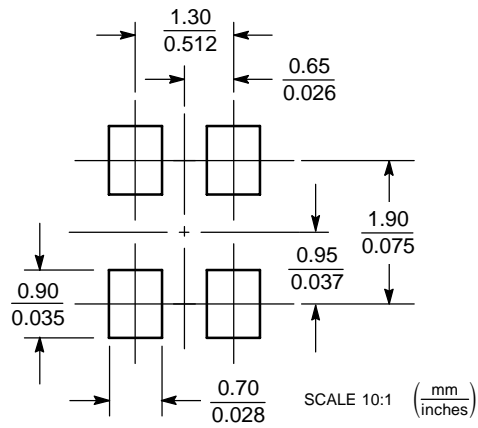

*For additional information on our Pb-Free strategy and soldering details, please download the ON Semiconductor Soldering and Mounting Techniques Reference Manual, SOLDERRM/D.

NCP580

ON Semiconductor and  are registered trademarks of Semiconductor Components Industries, LLC (SCILLC). SCILLC reserves the right to make changes without further notice to any products herein. SCILLC makes no warranty, representation or guarantee regarding the suitability of its products for any particular purpose, nor does SCILLC assume any liability arising out of the application or use of any product or circuit, and specifically disclaims any and all liability, including without limitation special, consequential or incidental damages. "Typical" parameters which may be provided in SCILLC data sheets and/or specifications can and do vary in different applications and actual performance may vary over time. All operating parameters, including "Typicals" must be validated for each customer application by customer's technical experts. SCILLC does not convey any license under its patent rights nor the rights of others. SCILLC products are not designed, intended, or authorized for use as components in systems intended for surgical implant into the body, or other applications intended to support or sustain life, or for any other application in which the failure of the SCILLC product could create a situation where personal injury or death may occur. Should Buyer purchase or use SCILLC products for any such unintended or unauthorized application, Buyer shall indemnify and hold SCILLC and its officers, employees, subsidiaries, affiliates, and distributors harmless against all claims, costs, damages, and expenses, and reasonable attorney fees arising out of, directly or indirectly, any claim of personal injury or death associated with such unintended or unauthorized use, even if such claim alleges that SCILLC was negligent regarding the design or manufacture of the part. SCILLC is an Equal Opportunity/Affirmative Action Employer. This literature is subject to all applicable copyright laws and is not for resale in any manner.

PUBLICATION ORDERING INFORMATION

LITERATURE FULFILLMENT:

Literature Distribution Center for ON Semiconductor
P.O. Box 61312, Phoenix, Arizona 85082-1312 USA
Phone: 480-829-7710 or 800-344-3860 Toll Free USA/Canada
Fax: 480-829-7709 or 800-344-3867 Toll Free USA/Canada
Email: orderlit@onsemi.com

N. American Technical Support: 800-282-9855 Toll Free
USA/Canada

Japan: ON Semiconductor, Japan Customer Focus Center
2-9-1 Kamimeguro, Meguro-ku, Tokyo, Japan 153-0051
Phone: 81-3-5773-3850

ON Semiconductor Website: <http://onsemi.com>

Order Literature: <http://www.onsemi.com/litorder>

For additional information, please contact your
local Sales Representative.