

NCT47

High Precision Temperature-to-Voltage Converter

The NCT47 is linear output temperature sensor whose output voltage is directly proportional to measured temperature. The NCT47 can accurately measure temperature from -40°C to $+125^{\circ}\text{C}$.

For the NCT47, the output voltage range is typically 100mV at -40°C , 500mV at 0°C , 750mV at $+25^{\circ}\text{C}$, and 1.75V at $+125^{\circ}\text{C}$. A 10mV/ $^{\circ}\text{C}$ voltage slope allows for the wide temperature range. The NCT47 is packaged in space saving 3-Pin SOT-23B packages, making them ideal for space critical applications.

Features

- Wide Temperature Measurement Range: -40°C to 125°C
- High Temperature Converter Accuracy: $\pm 2^{\circ}\text{C}$ Max at 25°C
- Linear Temperature Slope: 10mV/ $^{\circ}\text{C}$
- 2.7V to 4.4V Operating Range
- Small 3-Pin SOT-23B Package
- Very Low Supply Current: 35 μA typical

Typical Applications

- Cellular Phones
- Power Supply Thermal Shutdown
- Temperature-Controlled Fans
- Temperature Measurement / Instrumentation
- Temperature Regulators
- Consumer Electronic
- Portable Battery Powered Equipment

FUNCTIONAL BLOCK DIAGRAM

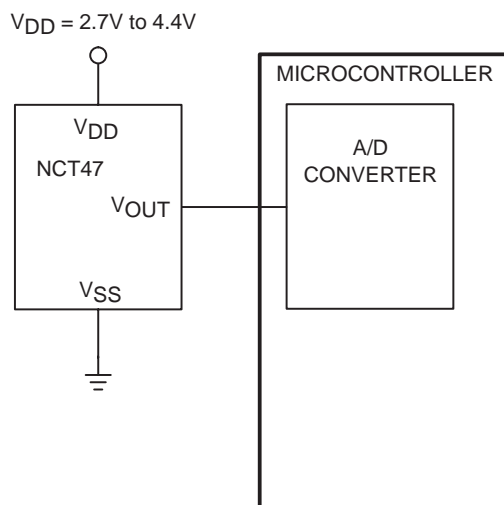

ON Semiconductor

<http://onsemi.com>

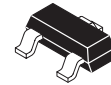

SOT-23B
(TO-236)
CASE TBD

PIN CONFIGURATION (Top View)

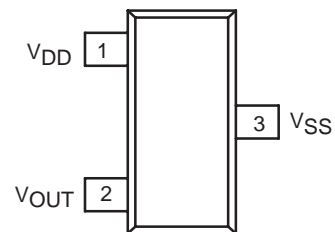

SOT-23B*

NOTE: *SOT-23B is equivalent to JEDEC (TO-236)

ORDERING INFORMATION

Device	Package	Shipping
NCT47SNT1	SOT-23B	3000 Tape/Reel

NCT47

ABSOLUTE MAXIMUM RATINGS*

Symbol	Parameter	Value	Unit
V _{DD}	Supply Voltage	+7.0	V
V _{SS}	Voltage on Any Pin with Respect to Supplies	(V _{SS} - 0.3) to (V _{DD} + 0.3)	V
T _A	Operating Temperature Range	-40 to +125	°C
T _{stg}	Storage Temperature Range	-55 to +150	°C
T _{sol}	Lead Temperature (Soldering, 10 Seconds)	+260	°C

* Maximum Ratings are those values beyond which damage to the device may occur.

ELECTRICAL CHARACTERISTICS (T_A = -40°C to +125°C, V_{DD} = 2.7V to 4.4V, unless otherwise noted.)

Symbol	Characteristic	Min	Typ	Max	Unit
V _{DD}	Supply Voltage	2.7	—	4.4	V
I _Q	Supply Current, Operating	—	35	60	μA
A _V	Average Slope of Output Voltage	—	10	—	mV/°C
TMP _{ACY25}	Temperature Accuracy at 25°C T _A = 25°C	-2.0	±0.5	+2.0	°C
TMP _{ACY125}	Temperature Accuracy T _A = 125°C	-3.0	—	+3.0	°C
TMP _{ACY-40}	Temperature Accuracy T _A = -40°C	—	1.5	—	°C
V _{OUT-40}	Output Voltage at -40°C	—	100	—	mV
V _{OUT+25}	Output Voltage at 25°C	730	750	770	mV
V _{OUT+125}	Output Voltage at 125°C	1720	1750	1780	mV
I _{OUT}	Output Source and Sink Current	100	—	—	μA

PIN DESCRIPTION

Pin No.	Symbol	Description
1	V _{DD}	Input Supply Voltage
2	V _{OUT}	Temperature Sensor Output Terminal
3	V _{SS}	Ground Terminal

DETAILED DESCRIPTION

The NCT47 has an output voltage that varies linearly with temperature in degrees Celsius. Figure 1 shows a plot of the output voltage versus temperature for the NCT47. The

temperature slope is fixed at 10 mV/°C, and the output voltage at 0°C is 500 mV.

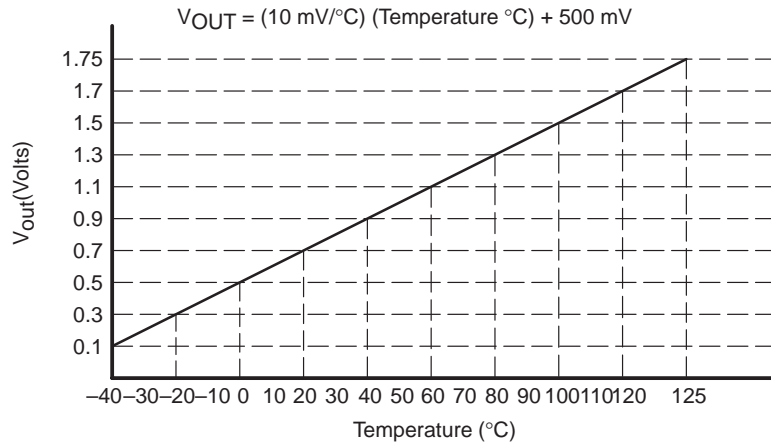

Figure 1. Output Voltage vs. Temperature

NCT47

TYPICAL CHARACTERISTICS

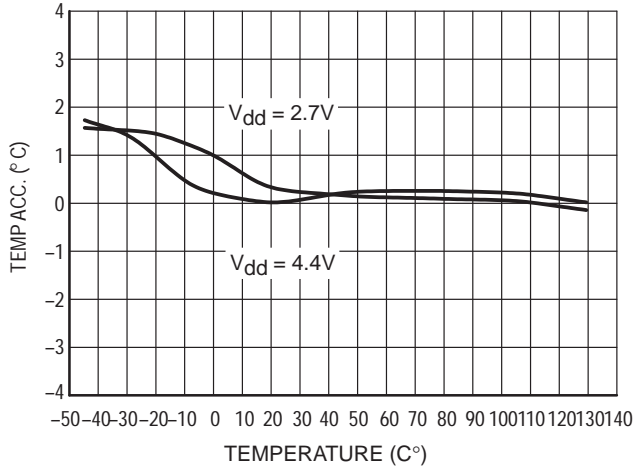

Figure 2. Temperature Accuracy vs Temperature

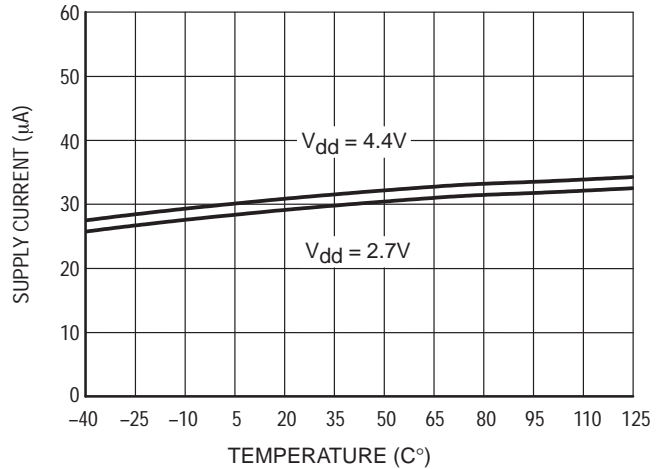
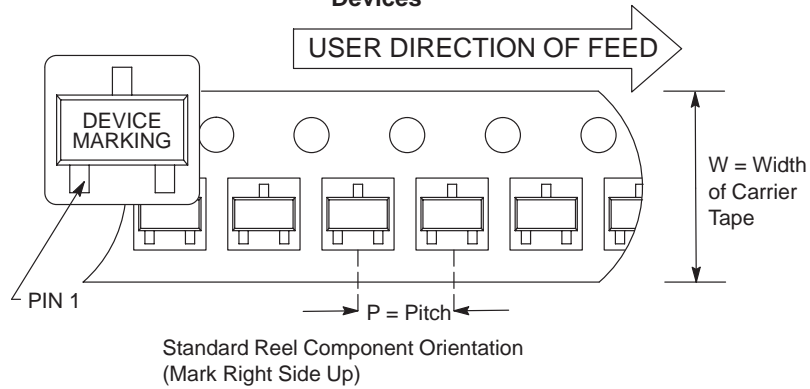

Figure 3. Supply Current vs Temperature

TAPING FORM

Component Taping Orientation for 3-Pin SOT-23B (JEDEC TO-236) Devices



Tape & Reel Specifications Table

Package	Carrier Width (W)	Pitch (P)	Part Per Full Reel	Reel Size
SOT-23B	8 mm	4 mm	3000	7 inches

MARKING DIAGRAM

SOT-23B

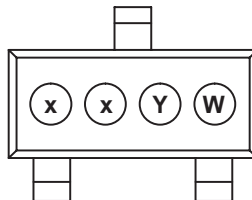



xx = part number code & temperature range
YW = Date Code

NCT47

PACKAGE DIMENSIONS

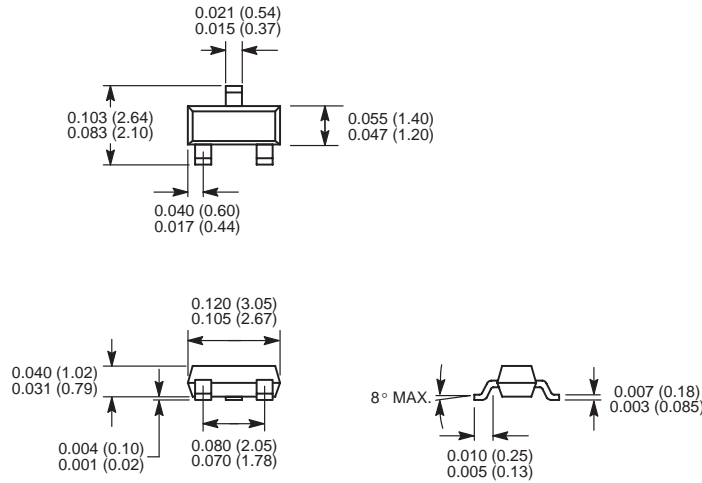
3-Pin SOT-23B (JEDEC TO-236)



ON Semiconductor and  are trademarks of Semiconductor Components Industries, LLC (SCILLC). SCILLC reserves the right to make changes without further notice to any products herein. SCILLC makes no warranty, representation or guarantee regarding the suitability of its products for any particular purpose, nor does SCILLC assume any liability arising out of the application or use of any product or circuit, and specifically disclaims any and all liability, including without limitation special, consequential or incidental damages. "Typical" parameters which may be provided in SCILLC data sheets and/or specifications can and do vary in different applications and actual performance may vary over time. All operating parameters, including "Typicals" must be validated for each customer application by customer's technical experts. SCILLC does not convey any license under its patent rights nor the rights of others. SCILLC products are not designed, intended, or authorized for use as components in systems intended for surgical implant into the body, or other applications intended to support or sustain life, or for any other application in which the failure of the SCILLC product could create a situation where personal injury or death may occur. Should Buyer purchase or use SCILLC products for any such unintended or unauthorized application, Buyer shall indemnify and hold SCILLC and its officers, employees, subsidiaries, affiliates, and distributors harmless against all claims, costs, damages, and expenses, and reasonable attorney fees arising out of, directly or indirectly, any claim of personal injury or death associated with such unintended or unauthorized use, even if such claim alleges that SCILLC was negligent regarding the design or manufacture of the part. SCILLC is an Equal Opportunity/Affirmative Action Employer.

PUBLICATION ORDERING INFORMATION

NORTH AMERICA Literature Fulfillment:

Literature Distribution Center for ON Semiconductor
P.O. Box 5163, Denver, Colorado 80217 USA
Phone: 303-675-2175 or 800-344-3860 Toll Free USA/Canada
Fax: 303-675-2176 or 800-344-3867 Toll Free USA/Canada
Email: ONlit@hibbertco.com
Fax Response Line: 303-675-2167 or 800-344-3810 Toll Free USA/Canada

N. American Technical Support: 800-282-9855 Toll Free USA/Canada

EUROPE: LDC for ON Semiconductor – European Support

German Phone: (+1) 303-308-7140 (M-F 1:00pm to 5:00pm Munich Time)
Email: ONlit-german@hibbertco.com
French Phone: (+1) 303-308-7141 (M-F 1:00pm to 5:00pm Toulouse Time)
Email: ONlit-french@hibbertco.com
English Phone: (+1) 303-308-7142 (M-F 12:00pm to 5:00pm UK Time)
Email: ONlit@hibbertco.com

EUROPEAN TOLL-FREE ACCESS*: 00-800-4422-3781

*Available from Germany, France, Italy, England, Ireland

CENTRAL/SOUTH AMERICA:

Spanish Phone: 303-308-7143 (Mon-Fri 8:00am to 5:00pm MST)
Email: ONlit-spanish@hibbertco.com

ASIA/PACIFIC: LDC for ON Semiconductor – Asia Support

Phone: 303-675-2121 (Tue-Fri 9:00am to 1:00pm, Hong Kong Time)
Toll Free from Hong Kong & Singapore:
001-800-4422-3781
Email: ONlit-asia@hibbertco.com

JAPAN: ON Semiconductor, Japan Customer Focus Center

4-32-1 Nishi-Gotanda, Shinagawa-ku, Tokyo, Japan 141-8549
Phone: 81-3-5740-2745
Email: r14525@onsemi.com

ON Semiconductor Website: <http://onsemi.com>

For additional information, please contact your local Sales Representative.