

## DIGITAL OUTPUT PHOTO REFLECTOR

### GENERAL DESCRIPTION

The NJL5801K is thin package digital output type photo reflector which consist of New JRC original designed one chip photo receiving IC and high output LED.

### FEATURES

- Normally on type
- With schmitt trigger circuit
- TTL Compatible
- Built-in visible light cut-off filter.

### APPLICATIONS

- Tape end sensor
- Reel rotation sensor
- Paper detector, Paper end sensor
- Bar code reader
- Sensor of FDD, Robot, manufacturing installation, etc.

### OUTLINE (typ.) Unit: mm

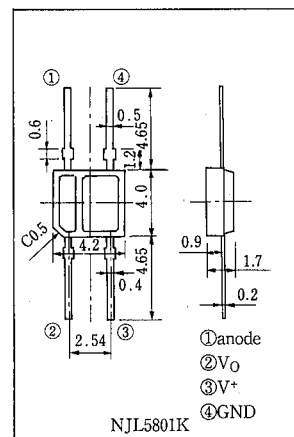

### ABSOLUTE MAXIMUM RATINGS (Ta=25°C)

PARAMETER	SYMBOL	RATINGS	UNIT
<b>Emitter</b>			
Forward Current (Continuous)	I <sub>F</sub>	50	mA
Reverse Voltage (Continuous)	V <sub>R</sub>	6	V
Power Dissipation	P <sub>D</sub>	75	mW
<b>Detector</b>			
Supply Voltage	V <sup>+</sup>	16	V
High Level Output Voltage	V <sub>OH</sub>	16	V
Low Level Output Current	I <sub>OL</sub>	50	mA
Power Dissipation	P <sub>O</sub>	110	mW
<b>Coupler</b>			
Total Power Dissipation	P <sub>tot</sub>	130	mW
Operating Temperature	T <sub>opr</sub>	-20~+85	°C
Storage Temperature	T <sub>stg</sub>	-30~+100	°C
Soldering Temperature	T <sub>sol</sub>	260	°C
		(5sec. 1.5mm from body)	

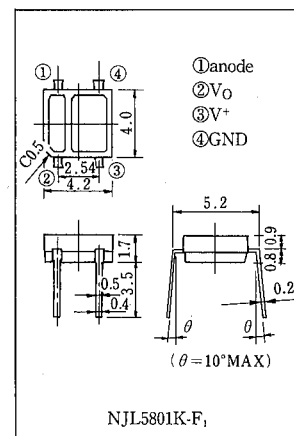

### BLOCK DIAGRAM

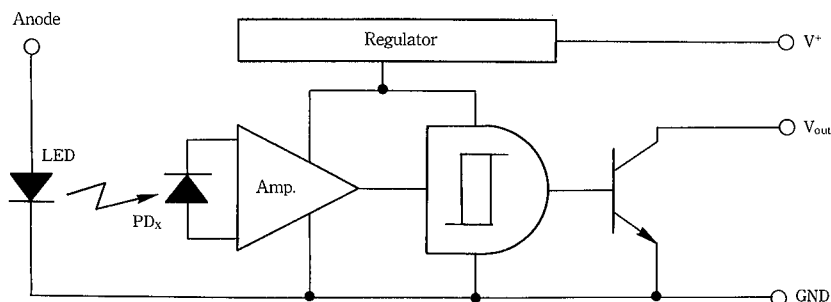

## ■ ELECTRO-OPTICAL CHARACTERISTICS (Ta=25°C)

PARAMETER	SYMBOL	TEST CONDITION	MIN.	TYP.	MAX.	UNIT
<b>Emitter</b>						
Forward Voltage	$V_F$	$I_F = 10\text{mA}$	—	1.1	1.3	V
Reverse Current	$I_R$	$V_R = 6\text{V}$	—	—	1.0	$\mu\text{A}$
Capacitance	$C_t$	$V_R = 0\text{V}, f = 1\text{MHz}$	—	25	—	pF
<b>Detector</b>						
Supply Voltage Range	$V^+$		3.5	—	15	V
Low Level Output Voltage	$V_{OL}$	$I_{OL} = 16\text{mA}, V^+ = 5\text{V}, I_F = 0\text{mA}$	—	0.2	0.5	V
High Level Output Current	$I_{OH}$	$V_O = V^+ = 15\text{V}, I_F = 10\text{mA}, d = 0.7\text{mm}$	—	—	100	$\mu\text{A}$
Low Level Supply Current	$I_{CCL}$	$V^+ = 5\text{V}, I_F = 0\text{mA}$	—	4.5	10	mA
High Level Supply Current	$I_{CCH}$	$V^+ = 5\text{V}, I_F = 10\text{mA}, d = 0.7\text{mm}$	—	3	10	mA
<b>Coupled</b>						
L→H Threshold Input Current	$I_{FLH}$	$V^+ = 5\text{V}, R_L = 280\Omega, d = 0.7\text{mm}$	—	—	10	mA
Hysteresis	$I_{FHL}/I_{FLH}$	$V^+ = 5\text{V}, R_L = 280\Omega, d = 0.7\text{mm}$	—	0.8	—	—
L→H Delay Time	$t_{PLH}$	$V^+ = 5\text{V}, R_L = 280\Omega, I_F = 10\text{mA}, d = 0.7\text{mm}$	—	10	—	$\mu\text{s}$
H→L Delay Time	$t_{PHL}$	$V^+ = 5\text{V}, R_L = 280\Omega, I_F = 10\text{mA}, d = 0.7\text{mm}$	—	5	—	$\mu\text{s}$
Rise Time	$t_r$	$V^+ = 5\text{V}, R_L = 280\Omega, I_F = 10\text{mA}, d = 0.7\text{mm}$	—	0.1	—	$\mu\text{s}$
Fall Time	$t_f$	$V^+ = 5\text{V}, R_L = 280\Omega, I_F = 10\text{mA}, d = 0.7\text{mm}$	—	0.1	—	$\mu\text{s}$

## ■ MEASURING SPECIFICATION FOR THRESHOLD INPUT CURRENT

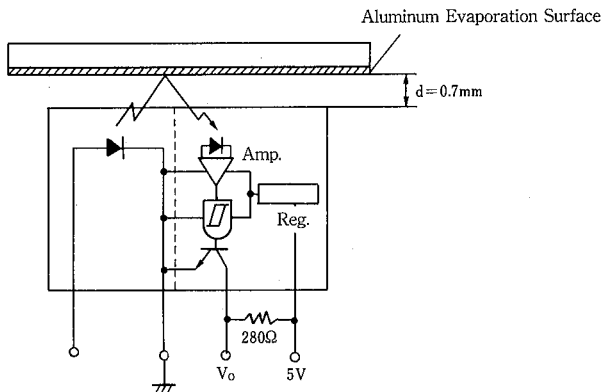

## ■ MAXIMUM RATING CURVES

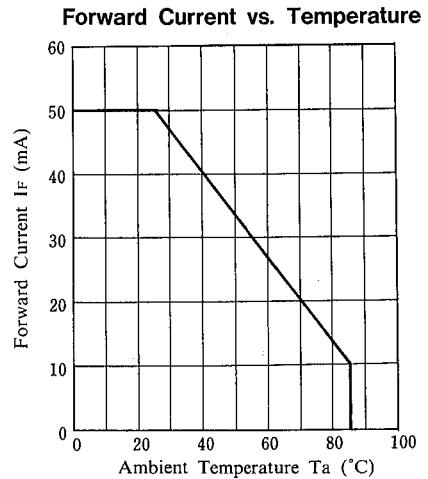
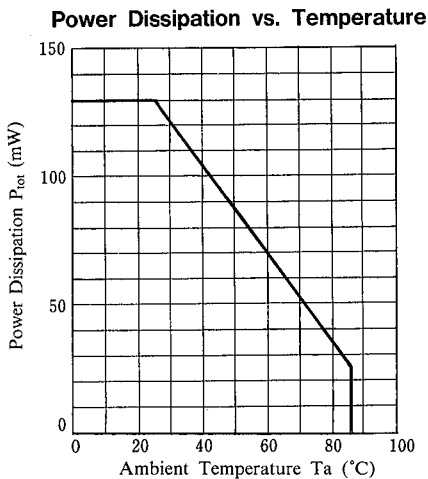

## TYPICAL CHARACTERISTICS

### Forward Current vs. Forward Voltage

( $T_a = 85^\circ\text{C}, 50^\circ\text{C}, 25^\circ\text{C}, 0^\circ\text{C}, -20^\circ\text{C}$ )

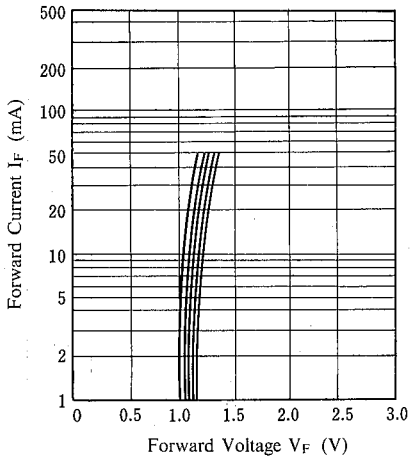

### Input Threshold Current vs. Supply Voltage

( $T_a = 25^\circ\text{C}$ )

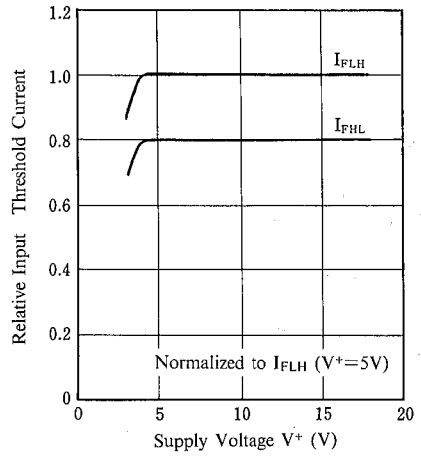

### Input Threshold Current vs. Temperature

( $V^+ = 5\text{V}$ )

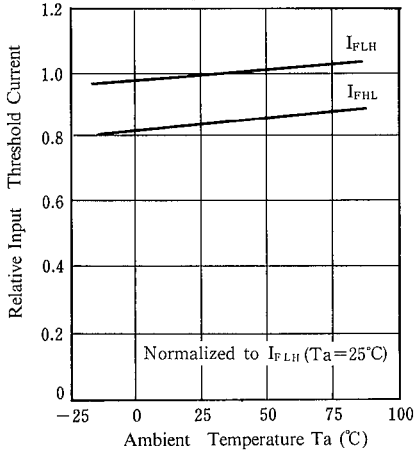

### Low Level Output Voltage vs. Low Level Output Current

( $V^+ = 5\text{V}, T_a = 25^\circ\text{C}$ )

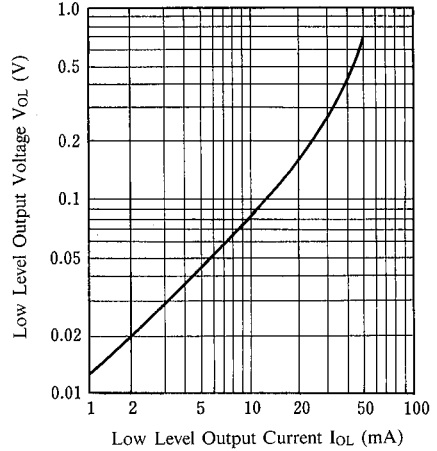

### Low Level Output Voltage vs. Temperature

( $V^+ = 5\text{V}$ )

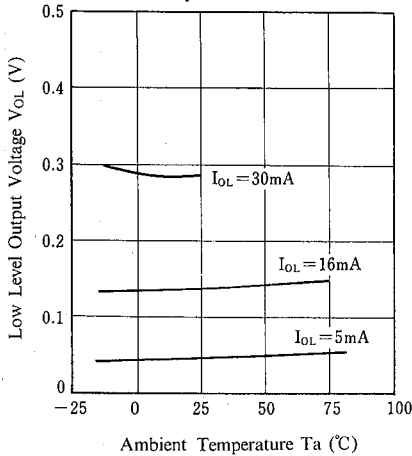

### Supply Current vs. Supply Voltage

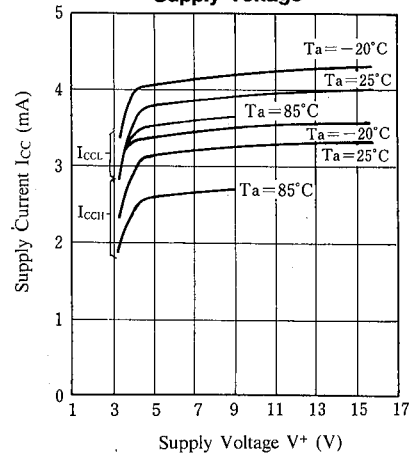

**Delay Time vs. Forward Current**

( $V^+=5V$ ,  $R_L=280\Omega$ ,  $T_a=25^\circ C$ )

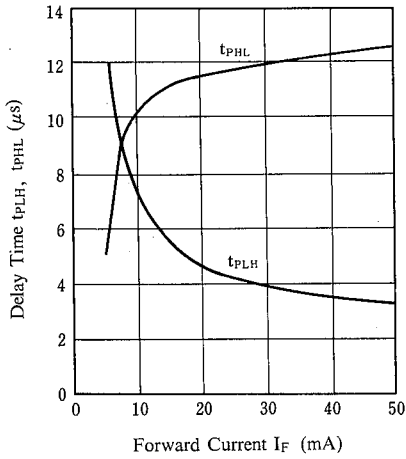

**Switching Time vs. Resistance**

( $V^+=5V$ ,  $I_F=10mA$ ,  $T_a=25^\circ C$ )

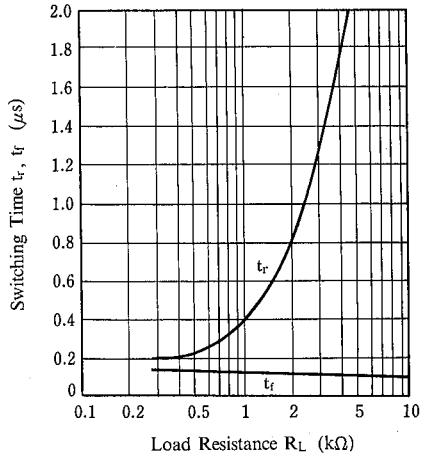

**Input Threshold Current vs. Distance**

( $V^+=5V$ ,  $R_L=280\Omega$ ,  $T_a=25^\circ C$ )

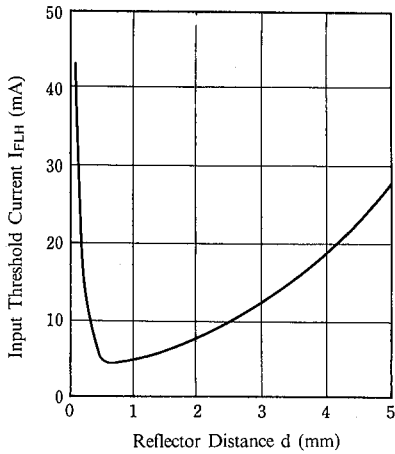

**Measuring Circuit for Response Time**

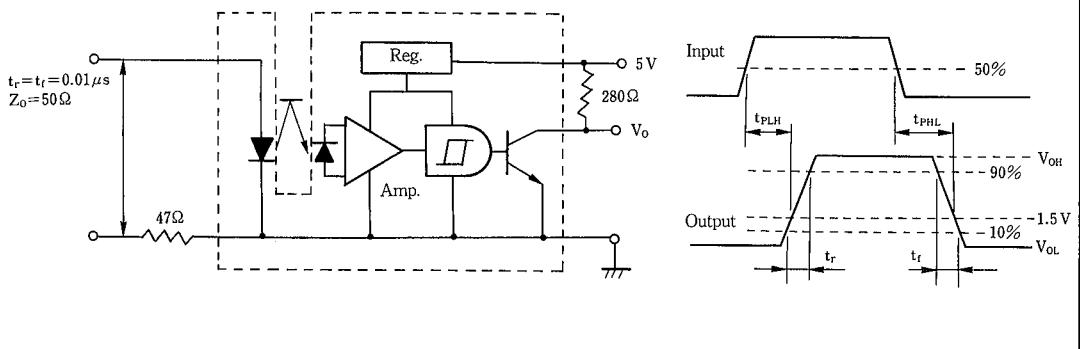

## MEMO

[CAUTION]

The specifications on this databook are only given for information, without any guarantee as regards either mistakes or omissions. The application circuits in this databook are described only to show representative usages of the product and not intended for the guarantee or permission of any right including the industrial rights.