

PHS MULTI-FUNCTION GaAs MMIC

■GENERAL DESCRIPTION

NJG1701V is a GaAs multi-function MMIC composed of a power amplifier, a SPDT switch and a LNA for Japanese PHS or WLL application. The SSOP20 package is adopted and effective for downsizing of handsets.

NJG1701V is operated at low voltage with low current and low distortion PA, low loss switch and low noise and high gain LNA.

■PACKAGE OUTLINE

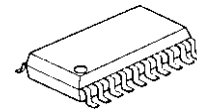

NJG1701V

■APPLICATION

- PHS, Digital cordless phone

■FEATURES

(Operating frequency $f=1.9\text{GHz}$)

Transmitting Mode Operation

- Drain Voltage (PA) 3.0V typ.
- Gain 32dB typ.
- Current consumption 160mA typ. @ $P_{OUT}=20\text{dBm}$
- Gain variable range 33dB typ.

Receiving Mode Operation

- Drain Voltage (LNA) 3.0 typ.
- Gain 14dB typ.
- Current consumption 2.8mA typ.
- NF 2.7dB typ.
- Control Voltage (SW) 2.7V typ.
- Package SSOP20 (Mount Size: 6.4x6.5x1.25mm)

■PIN CONFIGURATION

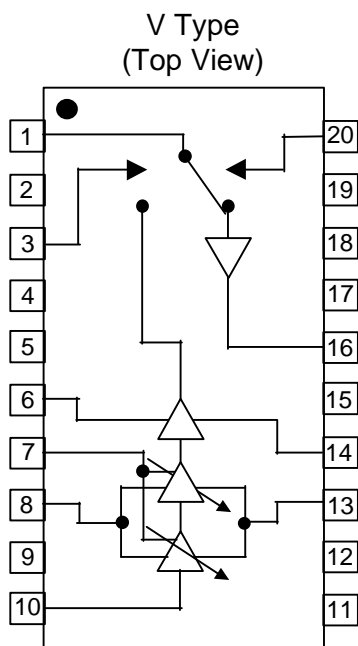

Pin Connection

1.ANT	11.GND
2.GND	12.GND
3. V_{SW2}	13. V_{DD3}
4.GND	14. V_{DD2}
5. V_{DD1}	15.GND
6. V_{GG1}	16.LNAOUT
7. V_{CONT}	17.GND
8. V_{GG2}	18.EXTIND
9.GND	19.GND
10. PA_{IN}	20. V_{SW1}

NJG1701V

■ABSOLUTE MAXIMUM RATINGS

($Z_s=Z_l=50\Omega$, $T_a=25^\circ\text{C}$)

PARAMETER	SYMBOL	CONDITIONS	RATINGS	UNITS
Drain Voltage1	V_{DD1}		6.0	V
Drain Voltage2	$V_{DD2,3}$	$V_{GG1,2}=-0.9\text{V}$	6.0	V
Gate Voltage	$V_{GG1,2}$	$V_{DD2,3}=3.0\text{V}$	-4.0	V
Gain Control Voltage	V_{cont}	$V_{DD2,3}=3.0\text{V}$	-4.0	V
Control Voltage	$V_{SW1,2}$		6.0	V
Input Power1	ANT	$V_{DD1}=3.0\text{V}$, $V_{SW1}=0\text{V}$, $V_{SW2}=2.7\text{V}$	0	dBm
Input Power2	PA_{in}	$V_{DD2,3}=3.0\text{V}$, $V_{GG1,2}=-0.9\text{V}$	3	dBm
Power Dissipation	P_D	At on PCB board	800	mW
Operating Temp.	T_{opr}		-30~+85	$^\circ\text{C}$
Storage Temp.	T_{stg}		-40~+150	$^\circ\text{C}$

■ELECTRICAL CHARACTERISTICS 1 (TRANSMITTING MODE: PA_{in} -ANT)

($f=1.90\text{GHz}$, $V_{SW1}=2.7\text{V}$, $V_{SW2}=0\text{V}$, $V_{CONT}=0\text{V}$, $Z_s=Z_l=50\Omega$, $V_{DD1}=0\text{V}$, $T_a=25^\circ\text{C}$)

PARAMETER	SYMBOL	CONDITIONS	MIN	TYP	MAX	UNITS
Operating frequency	freq	$V_{DD2,3}=3.0\text{V}$	1.89	1.90	1.92	GHz
Drain voltage	$V_{DD2,3}$	$V_{DD2,3}=3.0\text{V}$, $I_{idle}=150\text{mA}$	2.9	3.0	5.2	V
Gate voltage	$V_{GG1,2}$	$V_{DD2,3}=3.0\text{V}$, No RF Signal	-1.3	-0.9	-0.5	V
Idle current *1	I_{idle}	$P_{out}=20\text{dBm}$, $V_{DD2,3}=3.0\text{V}$	145	150	155	mA
Operating current *1	$I_{DD2,3}$	$P_{out}=20\text{dBm}$, $V_{DD2,3}=3.0\text{V}$	145	160	175	mA
Gate current *2	I_{GG}	$P_{out}=20\text{dBm}$, $V_{DD2,3}=3.0\text{V}$	-50.0	-10.0	0.0	μA
Gain control terminal current	I_{CONT}	$-2.0 < V_{CONT} < 0.0\text{V}$	-5.0	-2.0	0.0	μA
Gain control voltage	V_{CONT}	$P_{out}=20\text{dBm}$, $V_{DD2,3}=3.0\text{V}$	-2.0	0.0	0.0	V
Control voltage1	V_{SW1}	$P_{out}=20\text{dBm}$, $V_{DD2,3}=3.0\text{V}$	2.5	2.7	5.2	V
Control voltage2	V_{SW2}	$P_{out}=20\text{dBm}$, $V_{DD2,3}=3.0\text{V}$	-0.2	0.0	0.2	V
Control current	I_{SW1}	$V_{DD2,3}=3.0\text{V}$, $I_{idle}=150\text{mA}$	-	4.0	12.0	μA
Small signal gain	Gain1	$V_{DD2,3}=3.0\text{V}$, $I_{idle}=150\text{mA}$	29	32	35	dB
Gain flatness	G_{flat1}	$V_{DD2,3}=3.0\text{V}$, $I_{idle}=150\text{mA}$	-	0.5	1.0	dB
Gain control range	G_{CONT}	$-2.0\text{V} < V_{CONT} < 0.0\text{V}$	29	33	37	dB
P_{out} at 1dB gain compression point	P_{-1dB}	$V_{DD2,3}=3.0\text{V}$, $I_{idle}=150\text{mA}$	20	22	-	dBm
Adjacent Channel Leakage Power 1	P_{acp1}	$P_{out}=20\text{dBm}$, offset=600kHz, $I_{idle}=150\text{mA}$ $P_{in}=\pi/4$ QPSK, $V_{DD2,3}=3.0\text{V}$	-	-60	-55	dBc
Adjacent Channel Leakage Power 2	P_{acp2}	$P_{out}=20\text{dBm}$, offset=900kHz, $I_{idle}=150\text{mA}$, $P_{in}=\pi/4$ QPSK, $V_{DD2,3}=3.0\text{V}$	-	-65	-60	dBc

PARAMETER	SYMBOL	CONDITIONS	MIN	TYP	MAX	UNITS
Harmonics	P_{hm}	$P_{out}=20dBm, V_{DD2,3}=3.0V$ $I_{idle}=150mA$	-	-40	-30	dBc
PA _{in} Port VSWR	VSWR1	$V_{DD2,3}=3.0V, I_{idle}=150mA$	-	1.7	2.2	
ANT-LNAOUT Isolation	I_{SL}	$V_{DD1}=0V, V_{SW1}=2.7V,$ $V_{SW2}=0V$	35	40	-	dB
ANT Port Load VSWR Tolerance	-	$P_{out}=20dBm, V_{DD2,3}=3.0V,$ $I_{idle}=150mA$	Parasitic Oscillation for Fundamental Signal Level : $\leq -60dBc$			
Switching time	T_{SW1}	Load VSWR=4:1, All phase	-	15	-	nS

■ ELECTRICAL CHARACTERISTICS 2 (RECEIVING MODE; ANT - LNAOUT)

($f=1.90GHz, V_{SW1}=0V, V_{SW2}=2.7V, Z_s=Z_l=50\Omega, V_{DD2,3}=V_{GG1,2}=V_{CONT}=0V, T_a=25^\circ C$)

PARAMETER	SYMBOL	CONDITIONS	MIN	TYP	MAX	UNITS
Operating frequency	freq	$V_{DD1}=3.0V$	1.89	1.90	1.92	GHz
Drain Voltage	V_{DD1}		2.7	3.0	5.2	V
Operating current *3	I_{DD1}	$V_{DD1}=3.0V$	2	2.8	4.2	mA
Control voltage1	V_{SW1}		-0.2	0.0	0.2	V
Control voltage2	V_{SW2}		2.5	2.7	5.2	
Control current	I_{SW2}		-	4.0	12.0	μA
Small signal gain	Gain2	$V_{DD1}=3.0V$	12	13	16	dB
Gain flatness	G_{flat2}	$V_{DD1}=3.0V$	-	0.5	1.0	dB
Noise figure	NF	$V_{DD1}=3.0V$	-	2.7	3.3	dB
ANT Port VSWR	VSWR2	$V_{DD1}=3.0V$	-	1.7	2.2	
LNAOUT Port VSWR	VSWR3	$V_{DD1}=3.0V$	-	2.0	2.5	
Output 3rd Intercept Point	OIP3	$V_{DD1}=3.0V$	-10	0	-	dBm
Switching time	T_{SW2}		-	15	-	nS

*1: Total current of V_{DD2} and V_{DD3} terminal.

*2: Total current of V_{GG1} and V_{GG2} terminal.

*3: Current of V_{DD1} terminal.

■ TYPICAL CHARACTERISTICS TRANSMITTING MODE

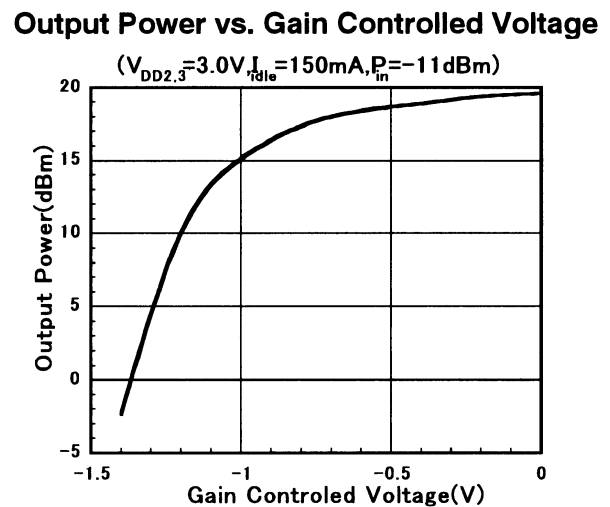
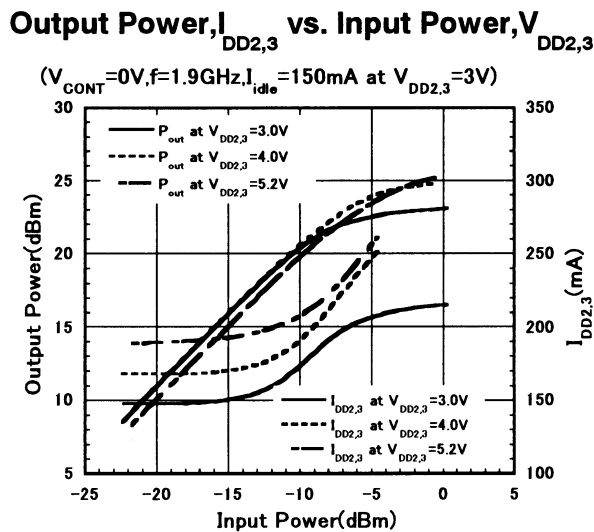
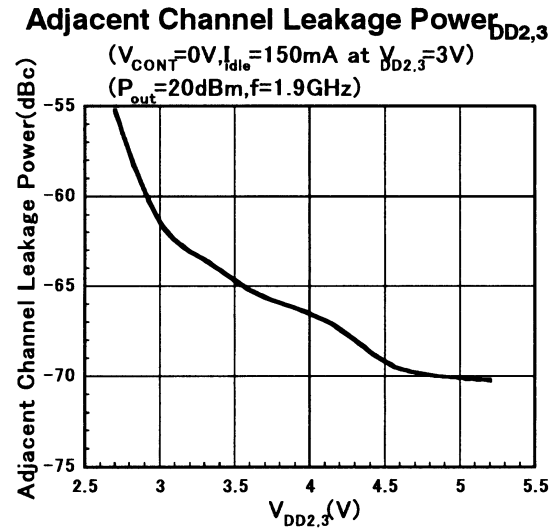
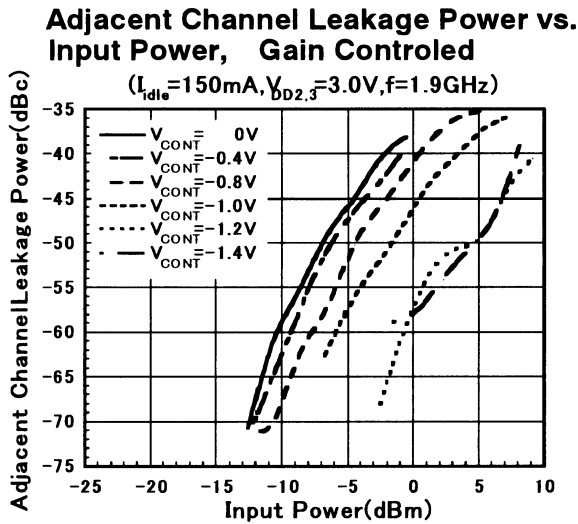
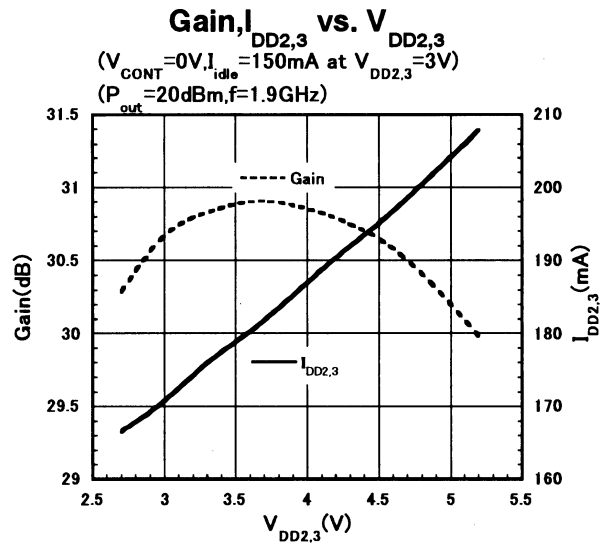
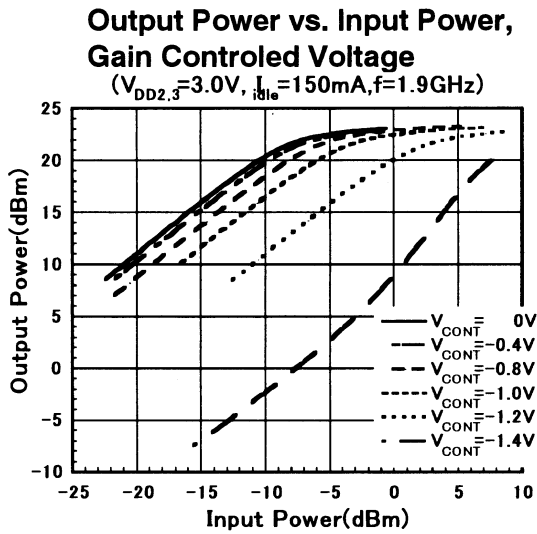

■ TYPICAL CHARACTERISTICS TRANSMITTING MODE

Adjacent Channel Leakage Power Gain Controlled Voltage $DD_{2,3}$

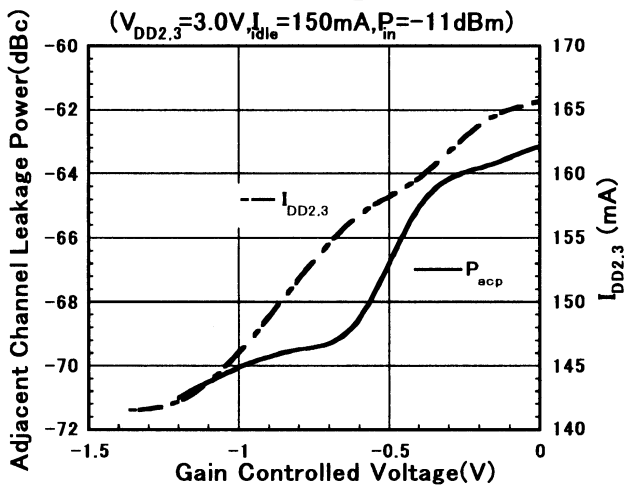

Output Power vs. Input Power, Temperature

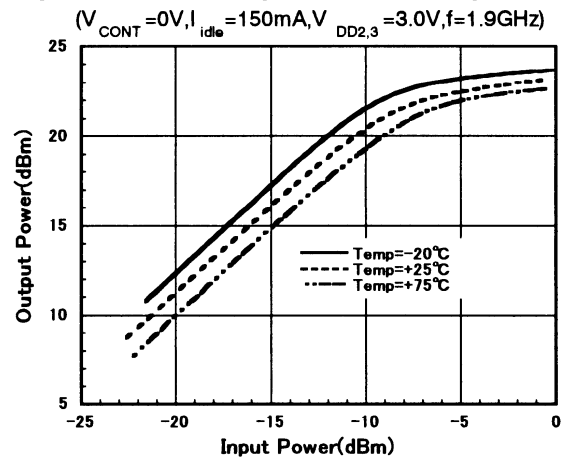

$I_{DD_{2,3}}$, Gain vs. Temperature

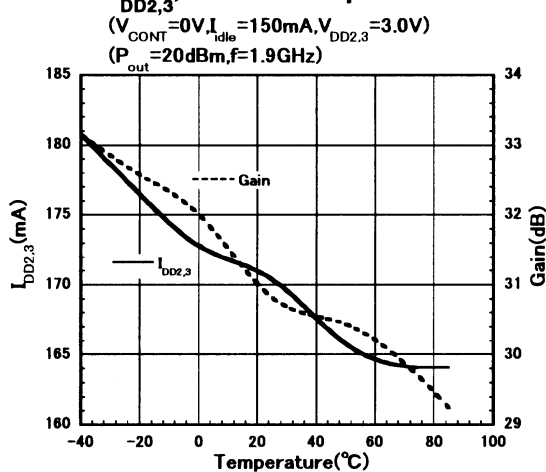

$I_{DD_{2,3}}$ vs. Input Power, Temperature

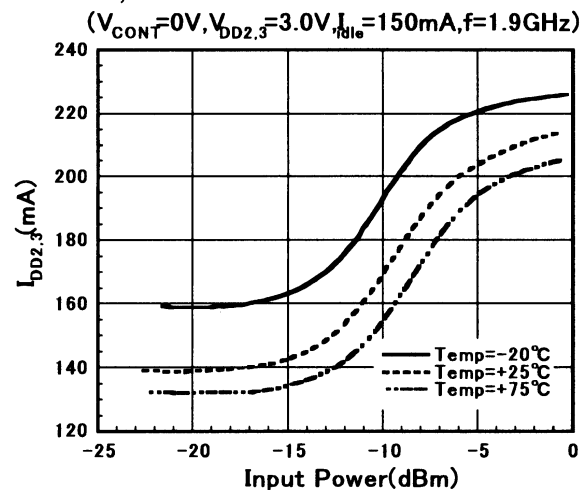

Adjacent Channel Leakage Power vs. Temperature

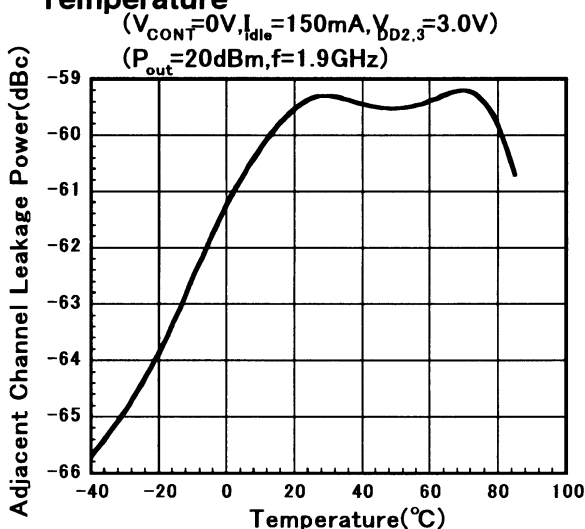

NJG1701V

■ TYPICAL CHARACTERISTICS TRANSMITTING MODE

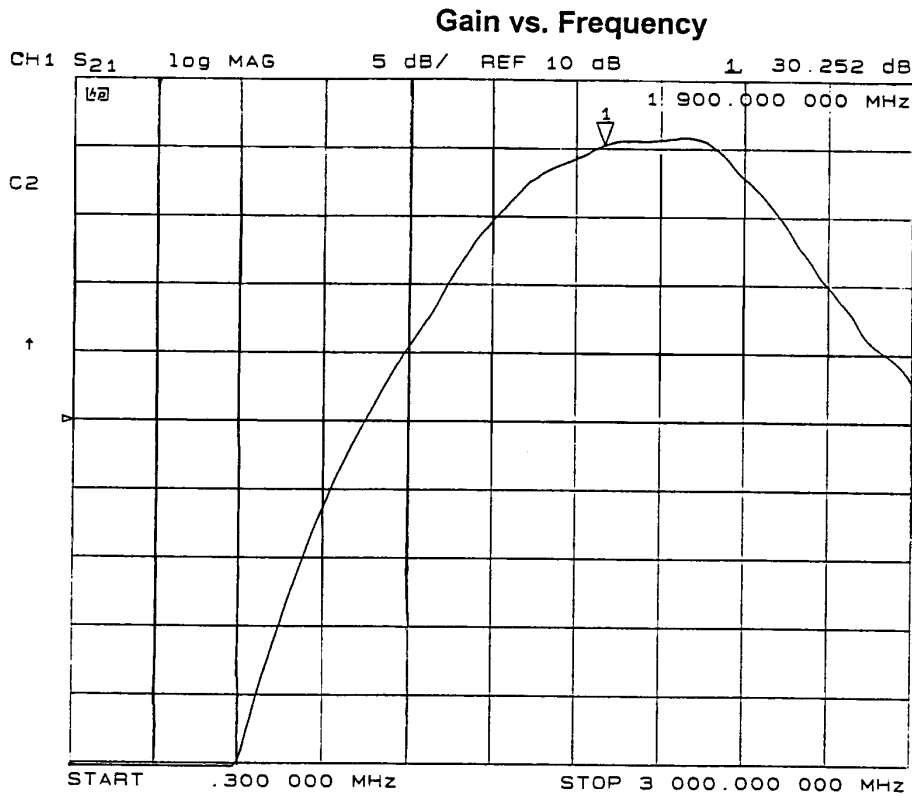

$V_{SW1}=2.7V$
 $V_{SW2}=0V$
 $V_{CONT}=0V$
 $V_{DD1}=0V$
 $V_{DD2,3}=3.0V$
 $I_{idle}=150mA$

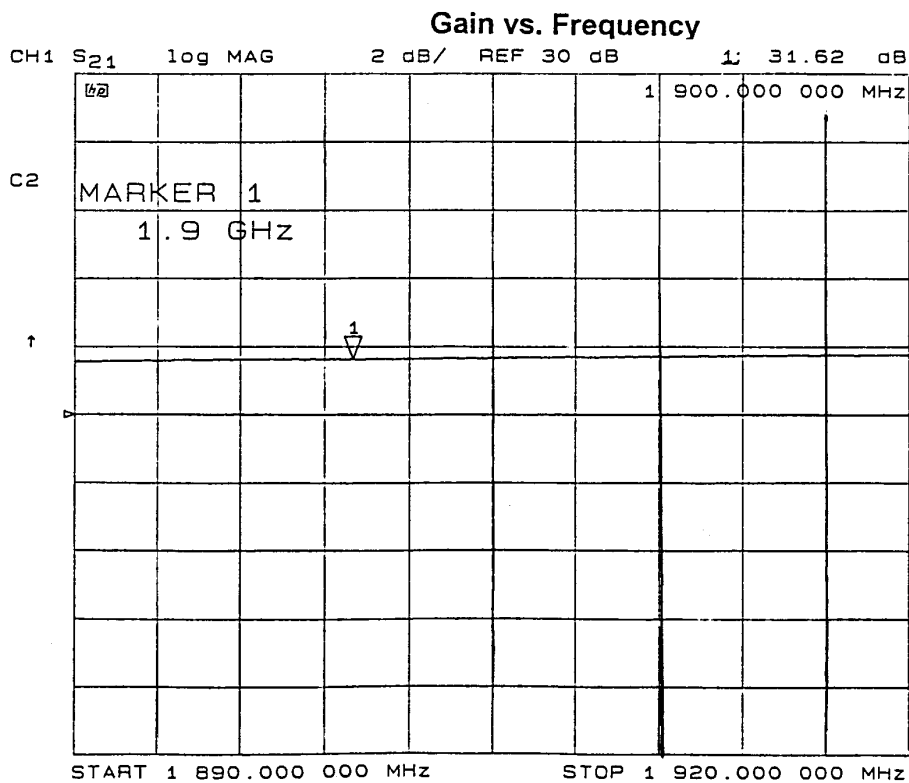

$V_{SW1}=2.7V$
 $V_{SW2}=0V$
 $V_{CONT}=0V$
 $V_{DD1}=0V$
 $V_{DD2,3}=3.0V$
 $I_{idle}=150mA$

■ TYPICAL CHARACTERISTICS TRANSMITTING MODE

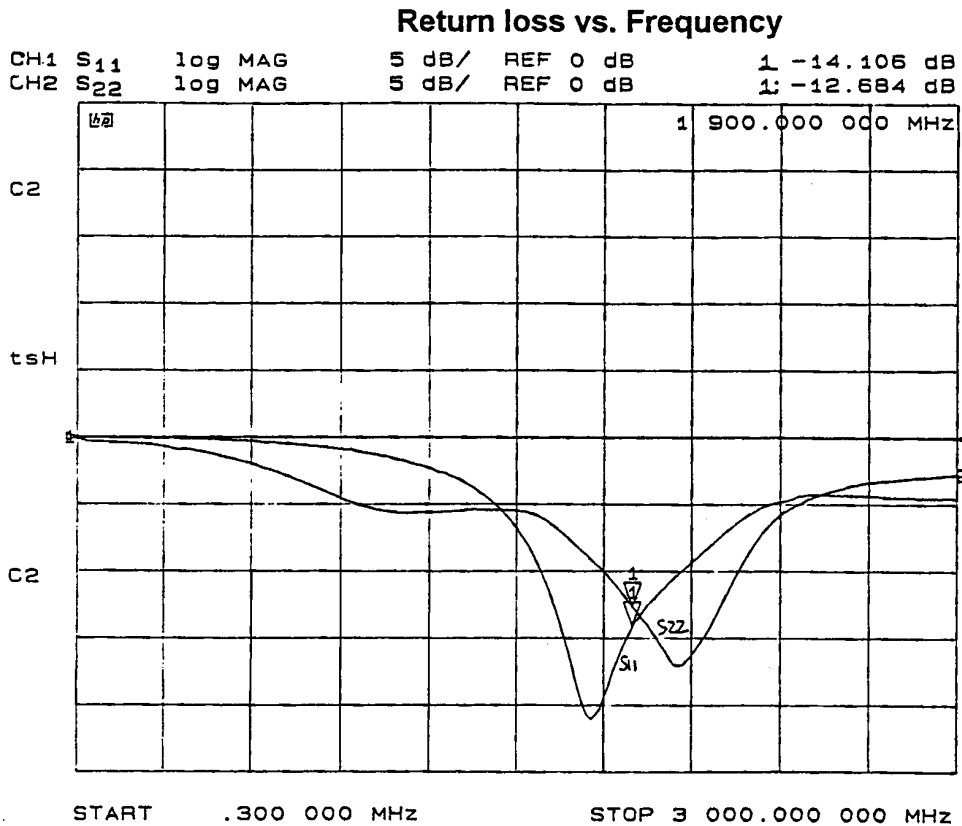

Adjacent Channel Leakage Power Spectrum

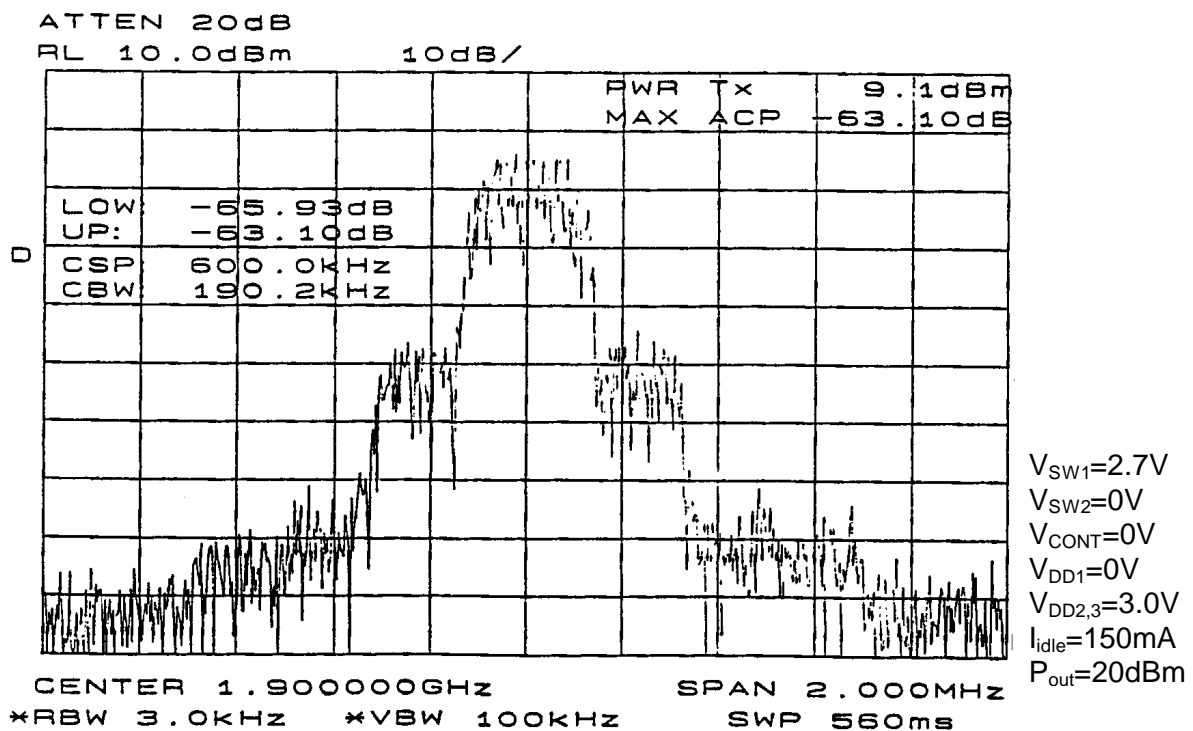

■ TYPICAL CHARACTERISTICS RECEIVING MODE

Noise Figure vs. Frequency

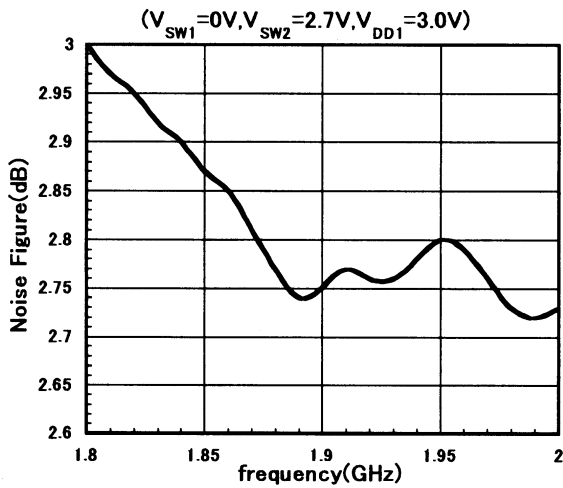

I_{DD1} , Gain vs Temperature

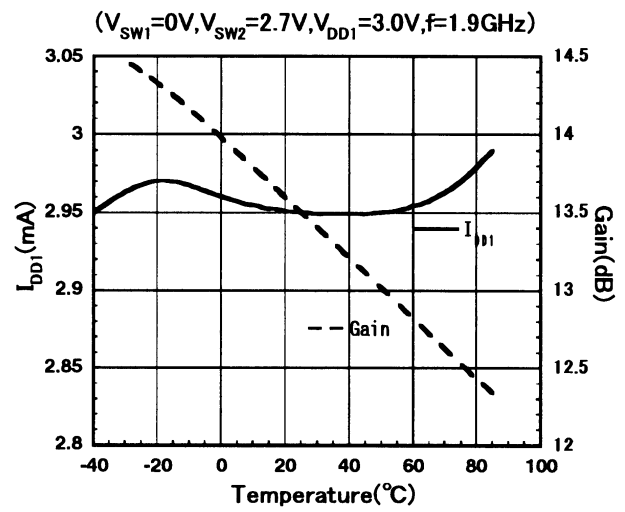

I_{DD1} , Gain vs Temperature

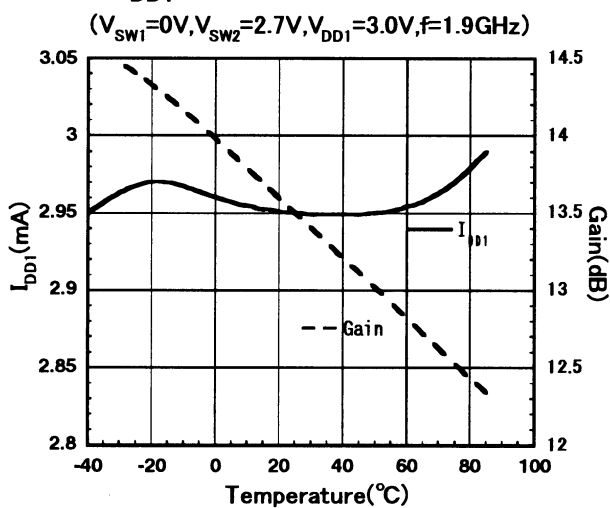

Noise Figure vs. Temperature

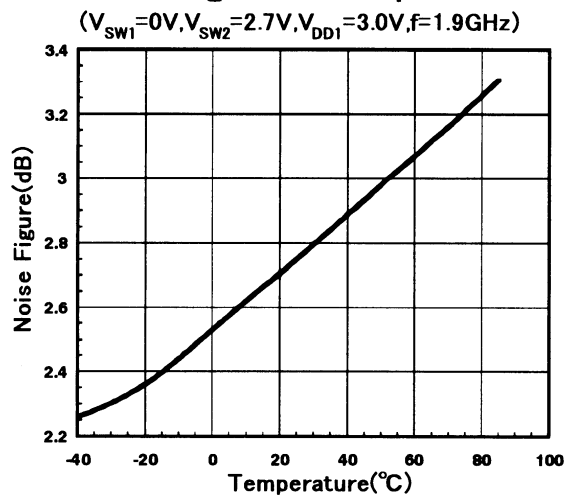

NJG1701V

■ TYPICAL CHARACTERISTICS RECEIVING MODE

Gain vs. Frequency

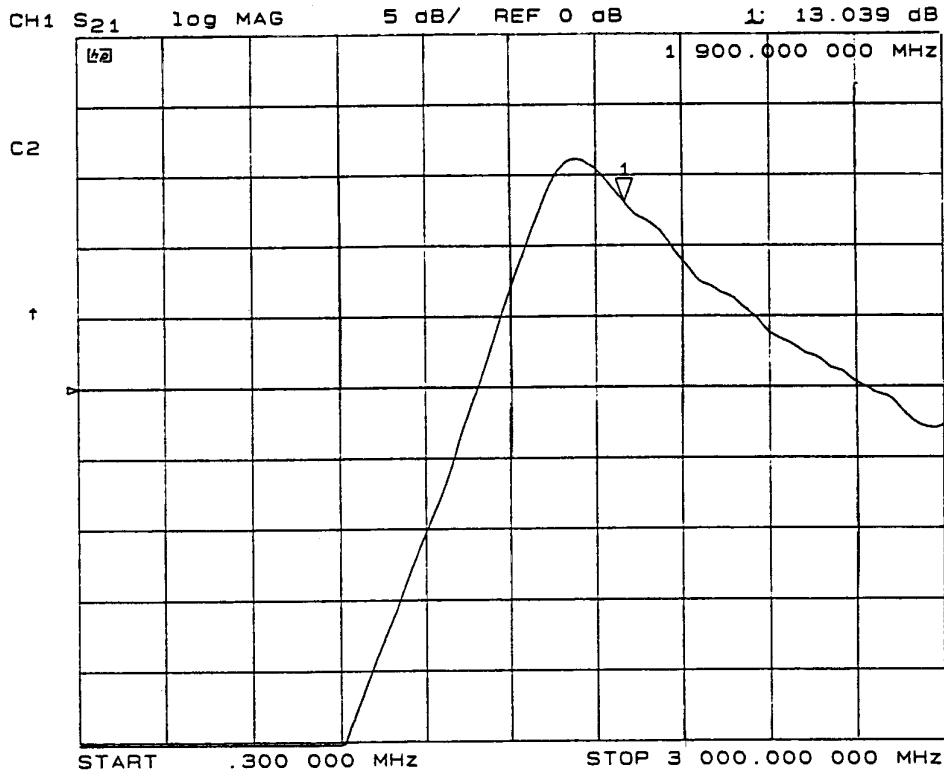

V_{SW1}=0V
V_{SW2}=2.7V
V_{DD1}=3.0V
V_{DD2,3}=0V

Return loss vs. Frequency

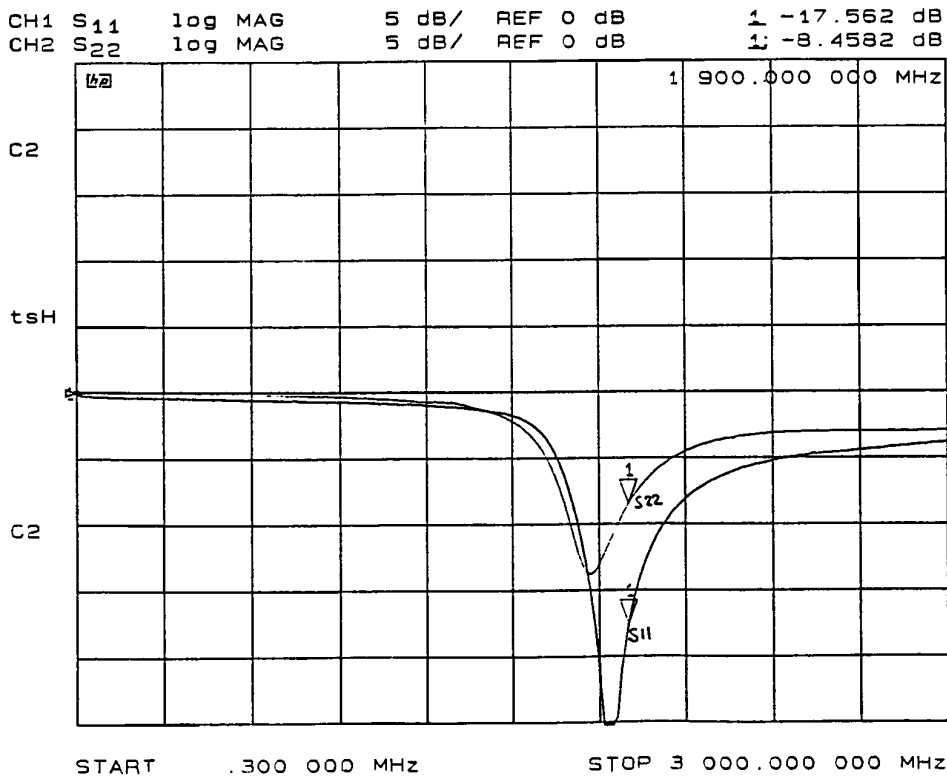

V_{SW1}=0V
V_{SW2}=2.7V
V_{DD1}=3.0V
V_{DD2,3}=0V

■ TYPICAL CHARACTERISTICS

TRANSMITTING MODE

Scattering parameters

$V_{SW1}=2.7V$, $V_{SW2}=0V$, $V_{CONT}=0V$, $V_{DD2,3}=3.0V$, $I_{idle}=150mA$

Freq [GHz]	S11		S21		S12		S22	
	mag [U]	ang [deg]	mag [U]	ang [deg]	mag [U]	ang [deg]	mag [U]	ang [deg]
0.10	0.984	-25.5	0.0014	-115.8	0.0002	179.8	0.962	-6.2
0.20	0.981	-49.5	0.0030	-44.1	0.0002	-75.8	0.954	-13.0
0.30	0.976	-75.2	0.0070	-127.1	0.0002	-46.6	0.931	-18.9
0.40	0.965	-99.5	0.0200	-135.3	0.0003	-159.3	0.908	-25.1
0.50	0.960	-124.4	0.0810	-179.6	0.0004	-167.4	0.858	-30.5
0.60	0.939	-148.7	0.2281	140.0	0.0007	175.0	0.806	-37.4
0.70	0.925	-174.3	0.5201	101.0	0.0010	149.8	0.744	-40.7
0.80	0.901	161.5	1.0599	61.5	0.0015	130.7	0.675	-45.7
0.90	0.871	136.2	1.9032	23.2	0.0019	108.2	0.618	-45.1
1.00	0.836	111.1	3.1884	-15.8	0.0023	85.2	0.578	-45.9
1.10	0.789	86.0	4.8575	-52.9	0.0028	66.7	0.569	-43.1
1.20	0.731	59.2	7.1517	-89.4	0.0032	45.7	0.568	-45.6
1.30	0.664	32.8	9.8763	-123.7	0.0034	28.9	0.576	-47.1
1.40	0.575	4.4	15.1324	-159.4	0.0038	12.3	0.579	-51.5
1.50	0.458	-24.2	20.2683	161.7	0.0041	-6.7	0.571	-57.3
1.60	0.291	-54.0	26.9543	119.7	0.0039	-28.2	0.513	-68.0
1.70	0.141	-76.4	31.9275	78.3	0.0034	-43.7	0.425	-73.8
1.80	0.060	6.2	36.4196	37.6	0.0030	-62.4	0.318	-73.5
1.89	0.153	10.7	39.8900	2.2	0.0026	-63.1	0.254	-67.9
1.90	0.165	8.9	40.2071	-1.8	0.0025	-63.9	0.246	-67.1
1.91	0.175	6.7	40.5122	-5.7	0.0024	-68.3	0.238	-66.1
1.92	0.187	4.9	40.9092	-9.8	0.0024	-68.0	0.231	-64.9
2.00	0.263	-4.4	43.9007	-40.9	0.0023	-64.0	0.185	-54.7
2.10	0.339	-26.2	48.4188	-82.2	0.0023	-65.5	0.142	-30.4
2.20	0.465	-44.1	50.0754	-128.9	0.0027	-70.3	0.196	13.3
2.30	0.577	-72.8	44.1354	-178.6	0.0030	-85.2	0.375	20.5
2.40	0.619	-100.2	32.6524	136.9	0.0027	-98.9	0.535	8.3
2.50	0.614	-126.2	22.5856	100.2	0.0026	-107.9	0.610	-2.2
2.60	0.593	-147.4	15.6441	70.2	0.0021	-122.9	0.670	-10.7
2.70	0.577	-166.4	11.2877	44.3	0.0020	-113.7	0.690	-15.9
2.80	0.569	174.5	8.2112	20.5	0.0017	-118.4	0.720	-20.9
2.90	0.548	156.9	6.2537	-1.0	0.0023	-114.8	0.724	-24.0
3.00	0.550	136.9	4.7160	-22.3	0.0019	-146.3	0.744	-29.2

NJG1701V

■ TYPICAL CHARACTERISTICS

RECEIVING MODE

Scattering parameters

$V_{SW1}=0V$, $V_{SW2}=2.7V$, $V_{DD1}=3.0V$

Freq [GHz]	S11		S21		S12		S22	
	mag [U]	ang [deg]	mag [U]	ang [deg]	mag [U]	ang [deg]	mag [U]	ang [deg]
0.10	0.949	-24.5	0.0007	-22.3	0.0001	-13.8	1.005	0.8
0.20	0.937	-47.2	0.0005	-94.2	0.0000	38.9	1.006	1.2
0.30	0.931	-71.7	0.0007	42.4	0.0003	49.0	1.001	2.6
0.40	0.924	-94.6	0.0012	56.9	0.0002	157.5	1.006	3.3
0.50	0.925	-118.2	0.0032	-12.0	0.0002	118.5	1.001	4.6
0.60	0.909	-141.3	0.0048	4.8	0.0002	42.3	0.994	4.3
0.70	0.903	-165.9	0.0122	-43.4	0.0001	51.9	0.988	6.1
0.80	0.896	171.2	0.0268	-74.1	0.0002	27.7	0.979	6.0
0.90	0.886	146.7	0.0507	-101.9	0.0003	-8.5	0.970	7.4
1.00	0.878	122.6	0.0945	-129.9	0.0008	-27.8	0.961	7.6
1.10	0.867	98.2	0.1660	-155.6	0.0012	-49.7	0.949	9.1
1.20	0.851	72.1	0.3007	177.2	0.0021	-71.0	0.932	8.2
1.30	0.841	45.4	0.5265	149.1	0.0035	-99.1	0.915	7.9
1.40	0.823	16.7	1.0462	119.6	0.0055	-119.6	0.880	4.5
1.50	0.795	-15.1	2.0399	81.6	0.0087	-151.5	0.813	0.3
1.60	0.699	-56.4	4.2567	28.6	0.0098	175.6	0.638	-9.5
1.70	0.442	-106.2	6.4879	-41.7	0.0104	158.5	0.339	-12.7
1.80	0.096	-154.7	6.2827	-111.1	0.0134	151.3	0.210	50.8
1.89	0.100	1.8	5.0324	-159.6	0.0184	133.0	0.363	76.3
1.90	0.119	-3.0	4.8886	-164.3	0.0190	130.5	0.381	77.2
1.91	0.140	-6.0	4.7393	-168.9	0.0198	128.9	0.399	78.0
1.92	0.160	-8.3	4.6134	-173.7	0.0200	126.9	0.415	78.6
2.00	0.272	-29.6	3.6972	154.5	0.0239	107.3	0.523	80.8
2.10	0.383	-62.5	2.8789	120.2	0.0275	83.8	0.614	81.7
2.20	0.460	-87.8	2.2786	90.7	0.0301	63.0	0.675	81.0
2.30	0.508	-113.9	1.8558	64.5	0.0322	43.6	0.712	83.0
2.40	0.532	-138.1	1.5508	40.2	0.0345	26.4	0.726	84.1
2.50	0.555	-162.4	1.3178	18.0	0.0365	9.2	0.736	88.3
2.60	0.566	174.6	1.1358	-4.1	0.0379	-7.0	0.733	90.1
2.70	0.575	152.2	0.9882	-24.6	0.0397	-22.0	0.744	95.7
2.80	0.587	129.6	0.8661	-45.3	0.0413	-38.1	0.737	99.0
2.90	0.584	106.3	0.7524	-64.4	0.0423	-53.3	0.756	105.4
3.00	0.609	84.3	0.6545	-83.0	0.0433	-67.8	0.754	110.5

■BLOCK DIAGRAM

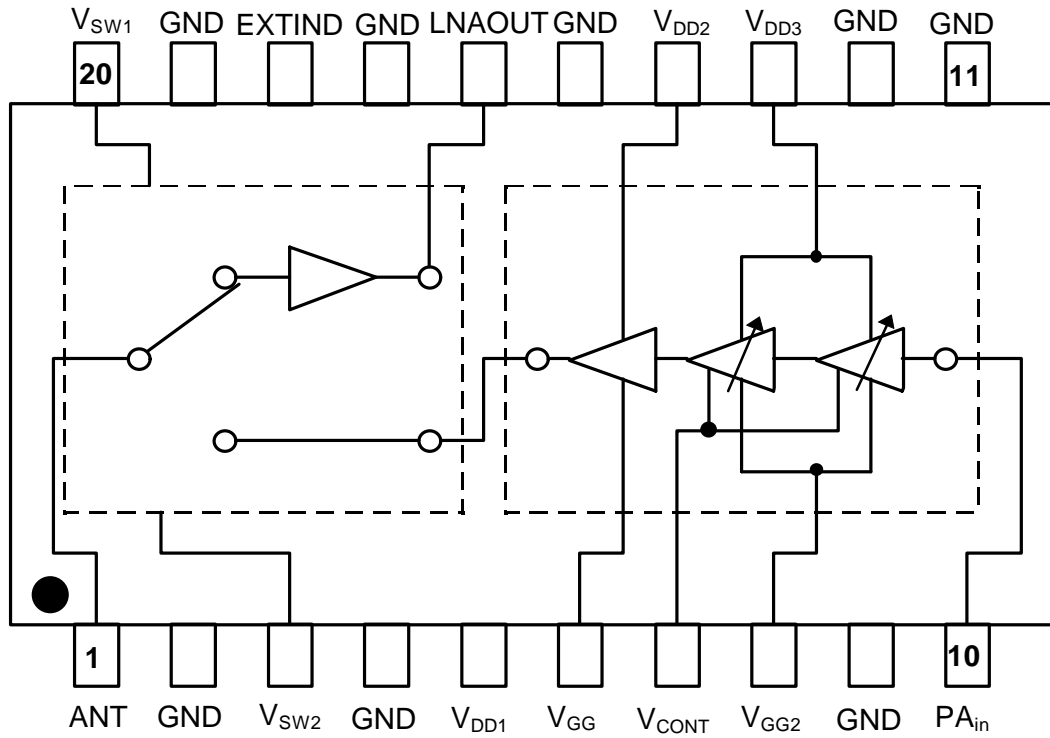

1

NJG1701V

APPLICATION CIRCUIT

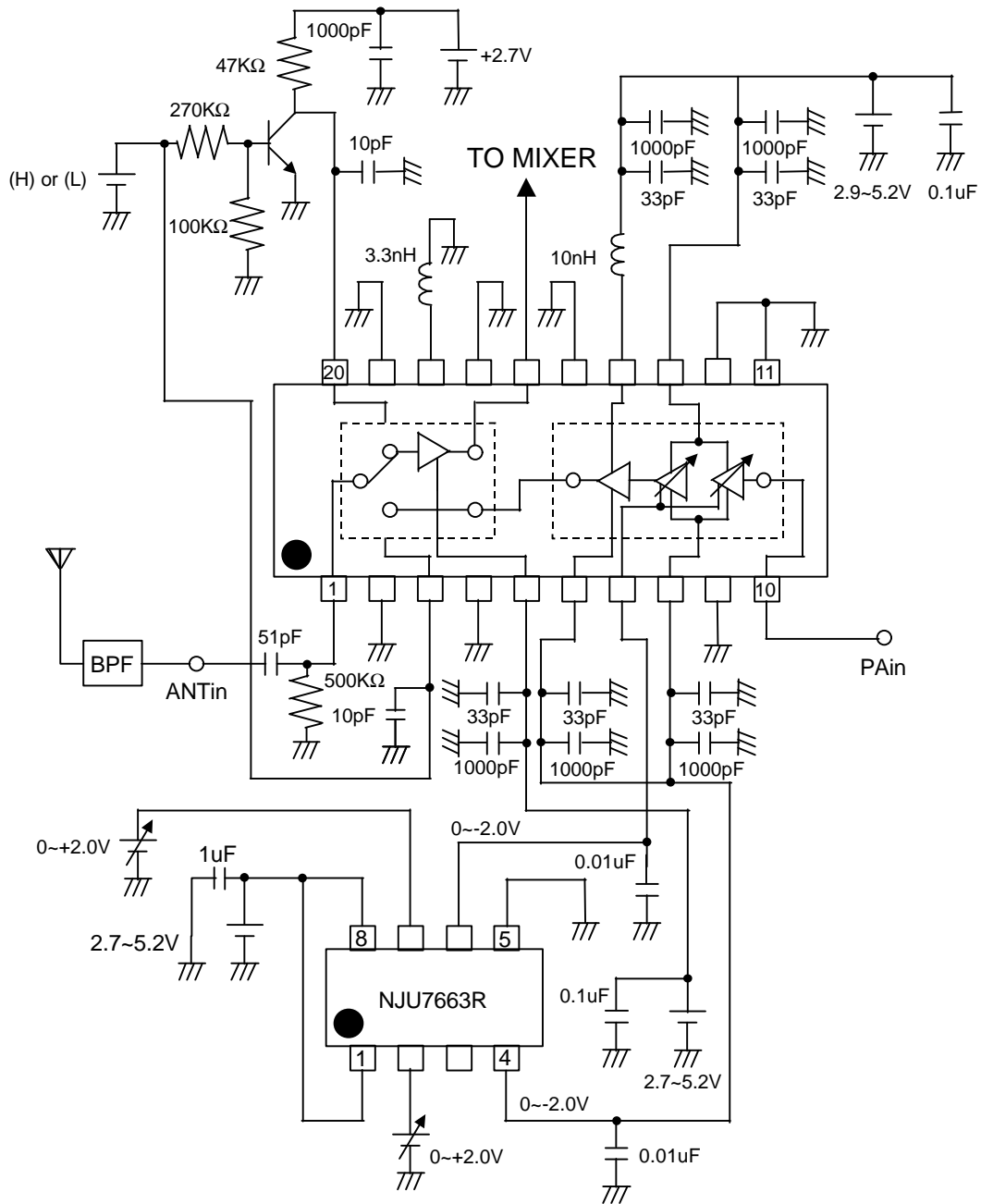

The reflow method is recommended to mount this device on PCB.

RECOMMENDED PCB DESIGN

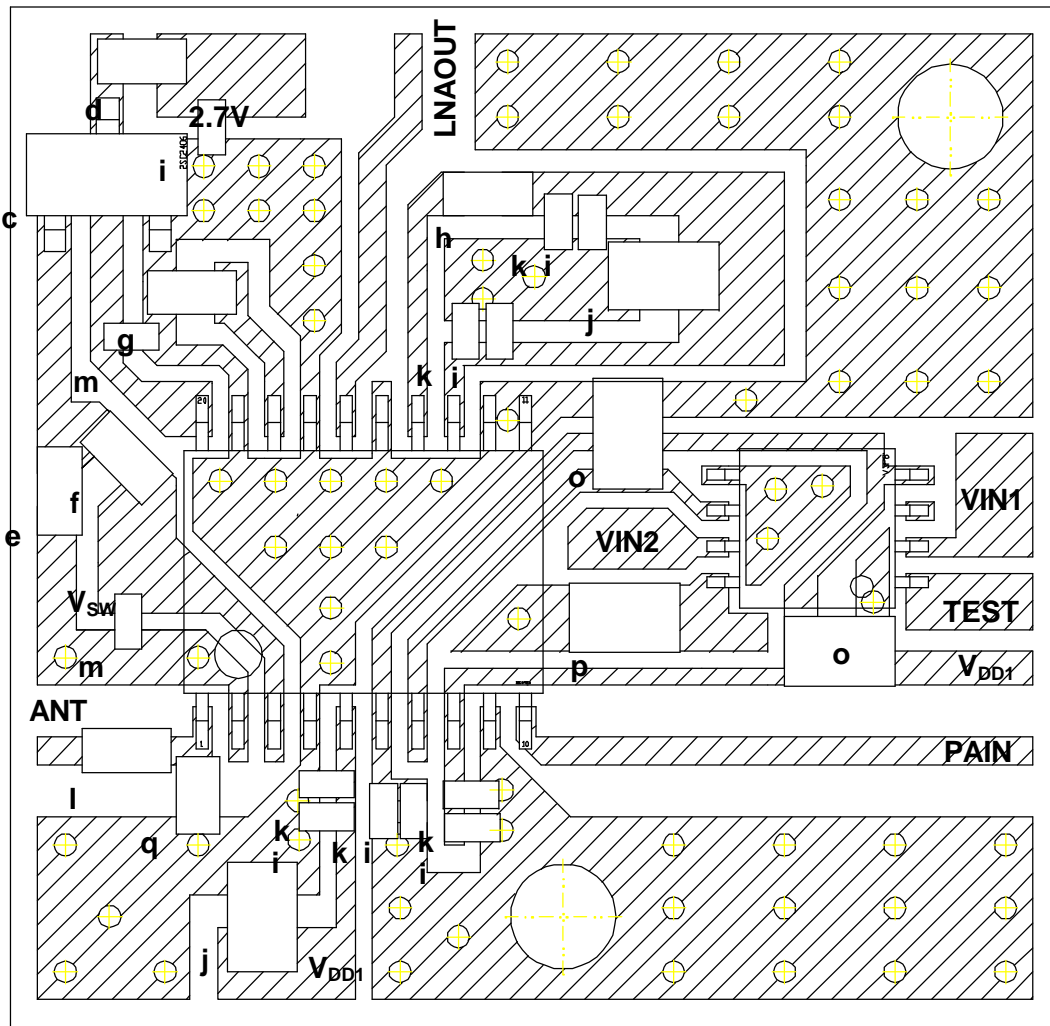

PCB SIZE 18.5 x 19mm

PCB: FR4 t=0.2mm

STRIP LINE WIDTH=0.4mm ($Z_0=50\Omega$)

Table 1 Parts list

Part ID	Constant	Comment	Part ID	Constant	Comment
a	NJG1701V		l	1000pF	MURATA(GRM36)
b	NJU7663R		j	0.1uF	MURATA(GRM40)
c	2SC4713K		k	33pF	MURATA(GRM36)
d	47K Ω	TAMA Electronics(CRG16G)	l	51pF	MURATA(GRM36)
e	100K Ω	TAMA Electronics(CRG16G)	m	10pF	MURATA(GRM36)
f	270K Ω	TAMA Electronics(CRG16G)	o	0.01uF	MURATA(GRM40)
g	3.3nH	TAIYO-YUDEN(HK1608)	p	1uF	MURATA(GRM40)
h	10nH	TAIYO-YUDEN(HK1608)	q	500K Ω	TAMA Electronics(CRG16G)

Note: The following list shows pin number and parts that should be connected as close as possible.
 #5 pin to k&i, #6 pin to k&l, #8 pin to k&l, #13 pin to k&i

NJG1701V

PACKAGE OUTLINE (SSOP20)

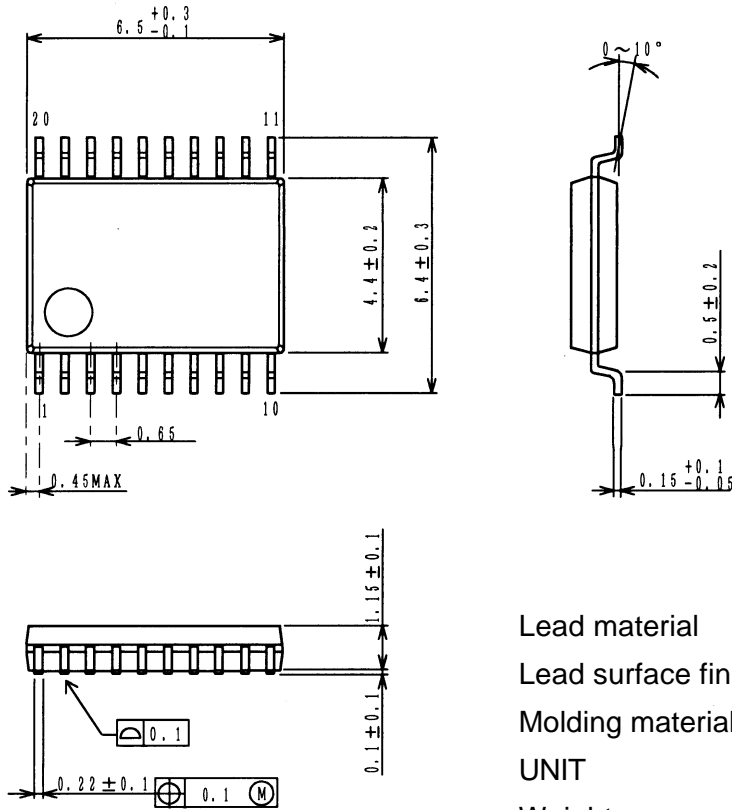

Lead material	: Copper
Lead surface finish	: Solder plating
Molding material	: Epoxy resin
UNIT	: mm
Weight	: 85mg

Cautions on using this product

- This product contains Gallium-Arsenide (GaAs) which is a harmful material.
- Do NOT eat or put into mouth.
 - Do NOT dispose in fire or break up this product.
 - Do NOT chemically make gas or powder with this product.
 - To waste this product, please obey the relating law of your country.

[CAUTION]

The specifications on this databook are only given for information, without any guarantee as regards either mistakes or omissions. The application circuits in this databook are described only to show representative usages of the product and not intended for the guarantee or permission of any right including the industrial rights.

This product may be damaged with electric static discharge (ESD) or spike voltage. Please handle with care to avoid these damages.