

# NTA4001N

## Small Signal MOSFET

20 V, 238 mA, Single, N-Channel, Gate ESD Protection, SC-75

### Features

- Low Gate Charge for Fast Switching
- Small 1.6 X 1.6 mm Footprint
- ESD Protected Gate
- Pb-Free Package for "Green Manufacturing" Compliance

### Applications

- Power Management Load Switch
- Level Shift
- Portable Applications such as Cell Phones, Media Players, Digital Cameras, PDA's, Video Games, Hand Held Computers, etc.

### Maximum Ratings (T<sub>J</sub> = 25°C unless otherwise stated)

Parameter		Symbol	Value	Unit
Drain-to-Source Voltage		V <sub>DSS</sub>	20	V
Gate-to-Source Voltage		V <sub>GS</sub>	±10	V
Continuous Drain Current (Note 1)	Steady State = 25°C	I <sub>D</sub>	238	mA
Power Dissipation (Note 1)	Steady State = 25°C	P <sub>D</sub>	300	mW
Pulsed Drain Current	t <sub>p</sub> ≤ 10 μs	I <sub>DM</sub>	714	mA
Operating Junction and Storage Temperature		T <sub>J</sub> , T <sub>STG</sub>	-55 to 150	°C
Continuous Source Current (Body Diode)		I <sub>SD</sub>	238	mA
Lead Temperature for Soldering Purposes (1/8" from case for 10 s)		T <sub>L</sub>	260	°C

### Thermal Resistance Ratings

Parameter	Symbol	Max	Unit
Junction-to-Ambient – Steady State (Note 1)	R <sub>θJA</sub>	416	°C/W

1. Surface-mounted on FR4 board using 1 in sq. pad size (Cu area = 1.127 in sq. [1 oz] including traces).



ON Semiconductor®

<http://onsemi.com>

V <sub>(BR)DSS</sub>	R <sub>DS(on)</sub> Typ @ V <sub>GS</sub>	I <sub>D</sub> MAX (Note 1)
20 V	1.5 Ω @ 4.5 V	238 mA
	2.2 Ω @ 2.5 V	

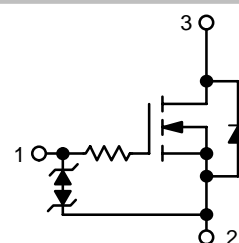

N-Channel

SC-75 (3-Leads)

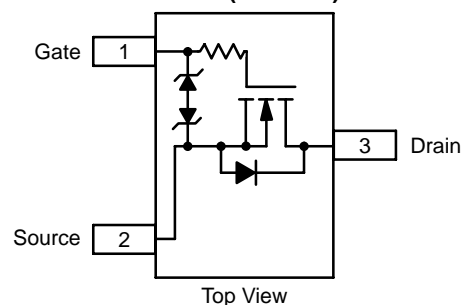

Top View

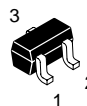

SC-75 / SOT-416  
CASE 463  
Style 5

### MARKING DIAGRAM

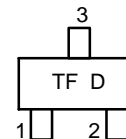

TF = Specific Device Code  
D = Date Code

### ORDERING INFORMATION

Device	Package	Shipping
NTA4001NT1	SC-75	3000 / Tape & Reel
NTA4001NT1G	SC-75 Pb-Free	3000 / Tape & Reel

# NTA4001N

## Electrical Characteristics ( $T_J = 25^\circ\text{C}$ unless otherwise specified)

Parameter	Symbol	Test Condition	Min	Typ	Max	Unit
-----------	--------	----------------	-----	-----	-----	------

### OFF CHARACTERISTICS

Drain-to-Source Breakdown Voltage	$V_{(BR)DSS}$	$V_{GS} = 0\text{ V}, I_D = 100\ \mu\text{A}$	20			V
Zero Gate Voltage Drain Current	$I_{DSS}$	$V_{GS} = 0\text{ V}, V_{DS} = 20\text{ V}$			1.0	$\mu\text{A}$
Gate-to-Source Leakage Current	$I_{GSS}$	$V_{DS} = 0\text{ V}, V_{GS} = \pm 10\text{ V}$			$\pm 100$	$\mu\text{A}$

### ON CHARACTERISTICS (Note 2)

Gate Threshold Voltage	$V_{GS(TH)}$	$V_{DS} = 3\text{ V}, I_D = 100\ \mu\text{A}$	0.5	1.0	1.5	V
Drain-to-Source On Resistance	$R_{DS(on)}$	$V_{GS} = 4.5\text{ V}, I_D = 10\text{ mA}$		1.5	3.0	$\Omega$
		$V_{GS} = 2.5\text{ V}, I_D = 10\text{ mA}$		2.2	3.5	
Forward Transconductance	$g_{FS}$	$V_{DS} = 3\text{ V}, I_D = 10\text{ mA}$		80		mS

### CAPACITANCES

Input Capacitance	$C_{ISS}$	$V_{DS} = 5\text{ V}, f = 1\text{ MHz}, V_{GS} = 0\text{ V}$		11.5		pF
Output Capacitance	$C_{OSS}$			10		
Reverse Transfer Capacitance	$C_{RSS}$			3.5		

### SWITCHING CHARACTERISTICS (Note 3)

Turn-On Delay Time	$t_{d(ON)}$	$V_{GS} = 4.5\text{ V}, V_{DS} = 5\text{ V}, I_D = 10\text{ mA}, R_G = 10\ \Omega$		13		ns
Rise Time	$t_r$			15		
Turn-Off Delay Time	$t_{d(OFF)}$			98		ns
Fall Time	$t_f$			60		

### Drain-Source Diode Characteristics

Forward Diode Voltage	$V_{SD}$	$V_{GS} = 0\text{ V}, I_S = 10\text{ mA}$		0.66	0.8	V
-----------------------	----------	---	--	------	-----	---

#### NOTES:

- Pulse Test: pulse width  $\leq 300\ \mu\text{s}$ , duty cycle  $\leq 2\%$ .
- Switching characteristics are independent of operating junction temperatures.

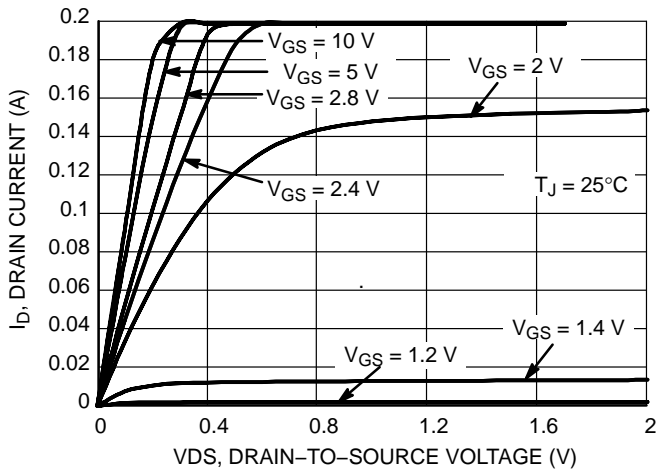

Figure 1. On-region Characteristics

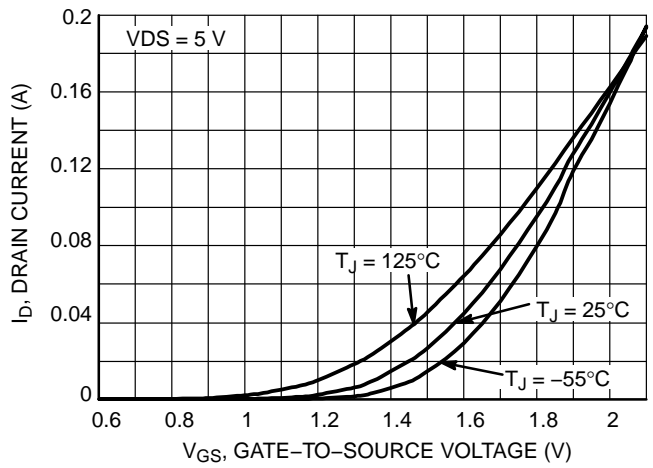

Figure 2. Transfer Characteristics

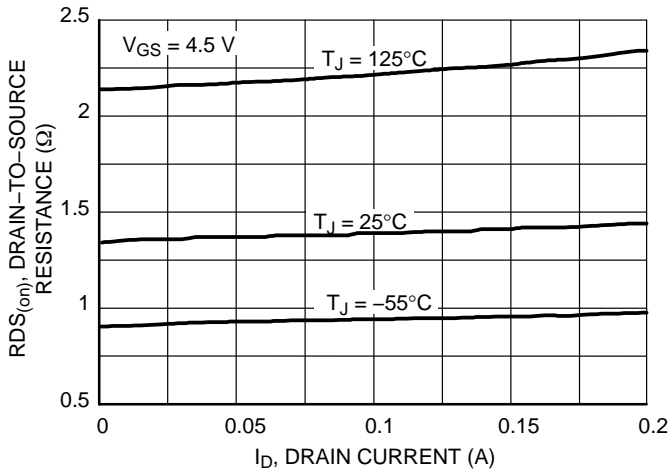

Figure 3. On-resistance versus Drain Current and Temperature

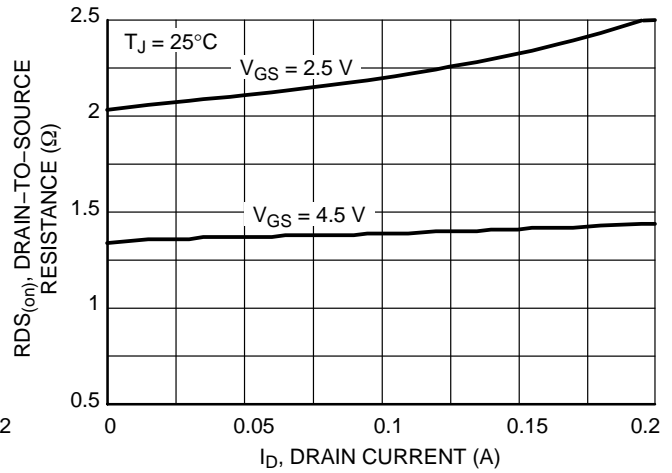

Figure 4. On-resistance versus Drain Current and Gate Voltage

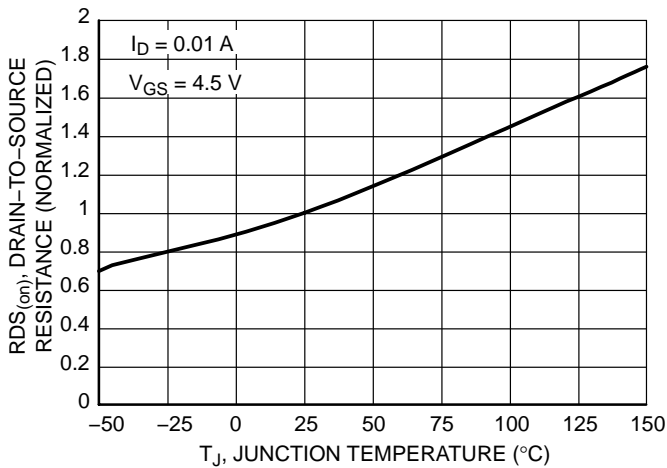

Figure 5. On-resistance Variation with Temperature

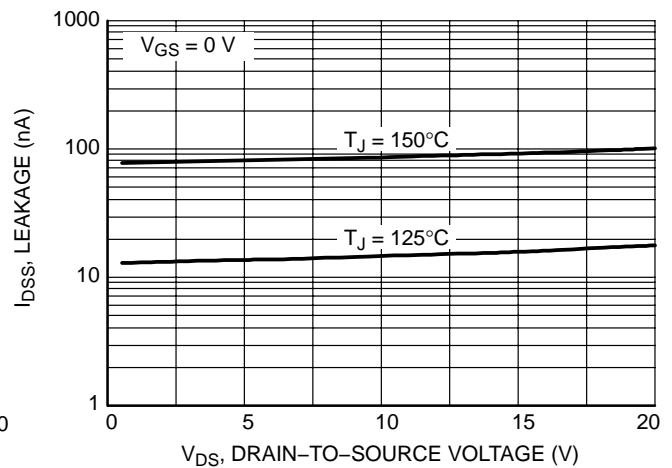
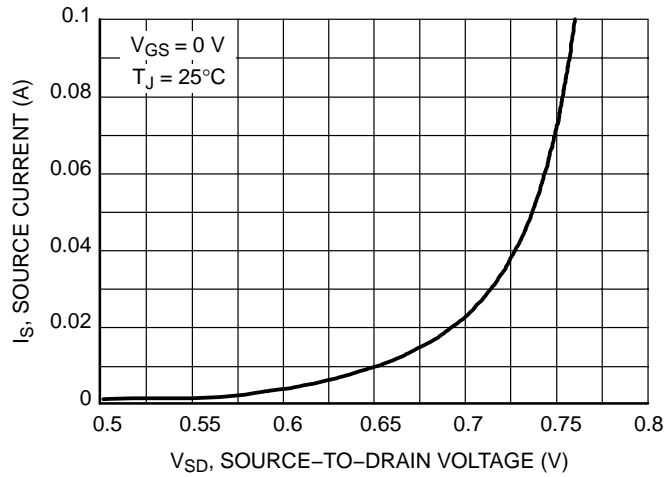
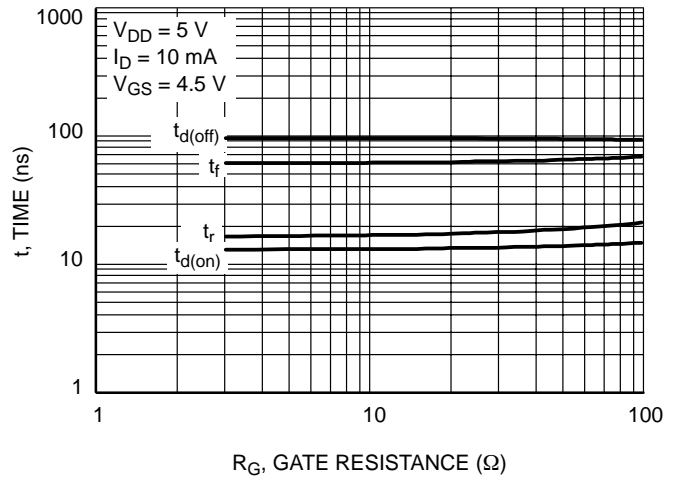
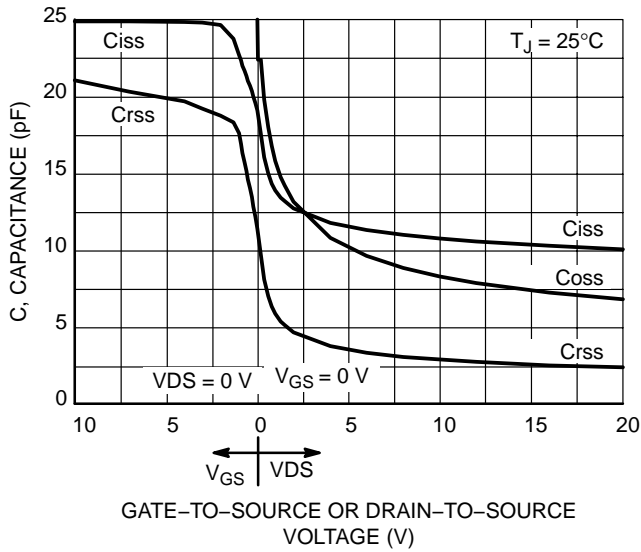

Figure 6. Drain-to-Source Leakage Current versus Voltage

# NTA4001N



# NTA4001N

## PACKAGE DIMENSIONS

SC-75 / SOT-416  
CASE 463-01  
ISSUE C

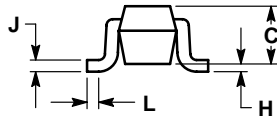
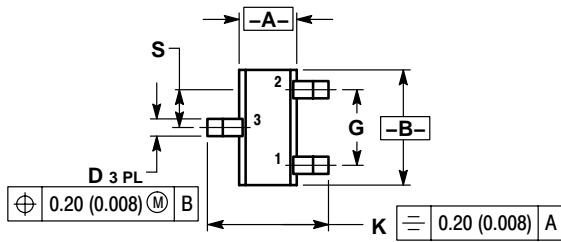

NOTES:

1. DIMENSIONING AND TOLERANCING PER ANSI Y14.5M, 1982.
2. CONTROLLING DIMENSION: MILLIMETER.

DIM	MILLIMETERS		INCHES	
	MIN	MAX	MIN	MAX
A	0.70	0.90	0.028	0.035
B	1.40	1.80	0.055	0.071
C	0.60	0.90	0.024	0.035
D	0.15	0.30	0.006	0.012
G	1.00 BSC		0.039 BSC	
H	---	0.10	---	0.004
J	0.10	0.25	0.004	0.010
K	1.45	1.75	0.057	0.069
L	0.10	0.20	0.004	0.008
S	0.50 BSC		0.020 BSC	

STYLE 5:

- PIN 1. GATE
- SOURCE
- DRAIN

# NTA4001N

**ON Semiconductor** and  are registered trademarks of Semiconductor Components Industries, LLC (SCILLC). SCILLC reserves the right to make changes without further notice to any products herein. SCILLC makes no warranty, representation or guarantee regarding the suitability of its products for any particular purpose, nor does SCILLC assume any liability arising out of the application or use of any product or circuit, and specifically disclaims any and all liability, including without limitation special, consequential or incidental damages. "Typical" parameters which may be provided in SCILLC data sheets and/or specifications can and do vary in different applications and actual performance may vary over time. All operating parameters, including "Typicals" must be validated for each customer application by customer's technical experts. SCILLC does not convey any license under its patent rights nor the rights of others. SCILLC products are not designed, intended, or authorized for use as components in systems intended for surgical implant into the body, or other applications intended to support or sustain life, or for any other application in which the failure of the SCILLC product could create a situation where personal injury or death may occur. Should Buyer purchase or use SCILLC products for any such unintended or unauthorized application, Buyer shall indemnify and hold SCILLC and its officers, employees, subsidiaries, affiliates, and distributors harmless against all claims, costs, damages, and expenses, and reasonable attorney fees arising out of, directly or indirectly, any claim of personal injury or death associated with such unintended or unauthorized use, even if such claim alleges that SCILLC was negligent regarding the design or manufacture of the part. SCILLC is an Equal Opportunity/Affirmative Action Employer. This literature is subject to all applicable copyright laws and is not for resale in any manner.

## PUBLICATION ORDERING INFORMATION

### LITERATURE FULFILLMENT:

Literature Distribution Center for ON Semiconductor  
P.O. Box 5163, Denver, Colorado 80217 USA

**Phone:** 303-675-2175 or 800-344-3860 Toll Free USA/Canada

**Fax:** 303-675-2176 or 800-344-3867 Toll Free USA/Canada

**Email:** [orderlit@onsemi.com](mailto:orderlit@onsemi.com)

**N. American Technical Support:** 800-282-9855 Toll Free  
USA/Canada

**Japan:** ON Semiconductor, Japan Customer Focus Center

2-9-1 Kamimeguro, Meguro-ku, Tokyo, Japan 153-0051

**Phone:** 81-3-5773-3850

**ON Semiconductor Website:** <http://onsemi.com>

**Order Literature:** <http://www.onsemi.com/litorder>

For additional information, please contact your  
local Sales Representative.