



**ISO  
LINK**

**OLF100**

**Phototransistor**

Hermetic Surface Mount **Optocoupler**

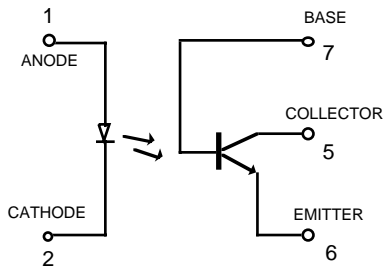

SCHEMATIC

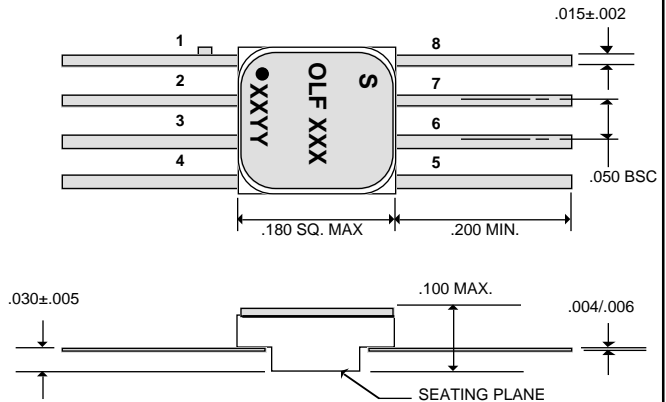

PACKAGE OUTLINE

## Features

- ◆ Hermetic SMT package
- ◆ Compliant surface mounting leads
- ◆ High current transfer ratio
- ◆ Small package size
- ◆ High reliability and rugged construction
- ◆ 100% hi-rel screenings are offered

## Description

The OLF 100 consists of a light emitting diode optically coupled to a NPN silicon phototransistor mounted in a 8-pin hermetic surface mount flat pack package. The leads can be formed to provide compliant solder connections to the mounting substrate.

Special electrical parametric selections are available on request.

### NOTES:

1. Measured between pins 1, 2, 3 and 4 shorted together and pins 5, 6, 7 and 8 shorted together. TA = 25°C and duration = 1 second.
2. Derate linearly to 125°C free-air temperature at 0.67 mA / °C above 65°C.
3. For pulse width ≤ 1 μS, pulse repetition rate ≤ 300 pps.
4. Derate linearly to 125°C free-air temperature at 3.0 mW / °C above 25 °C

## Absolute Maximum Ratings

Coupled	
Input to Output Isolation Voltage	± 1000 Vdc
Storage Temperature Range	-65 °C to + 150 °C
Operation Temperature Range	-55 °C to + 125 °C
Mounting Temperature Range ( 10 seconds max. )	240 °C
Input Diode	
Average Input Current	40 mA
Peak Forward Current	1 A
Reverse Voltage	2.0 V
Output Detector	
Collector - Emitter Voltage	40 V
Emitter - Base Voltage	7 V
Collector - Base Voltage	45 V
Continuous Collector Current	50 mA
Power Dissipation	300 mW

### ELECTRICAL CHARACTERISTIC ( T<sub>A</sub> = - 55 °C to +125 °C, Unless Otherwise Specified )

Parameter	Symbol	Min	Typ.	Max	Units	Test Conditions	Fig.	Note
Current Transfer Ratio	CTR	100 100	200 200		% %	I F = 10 mA, VCE = 5.0V I F = 1mA, VCE = 5.0V	2,3	2
Saturation Voltage	V <sub>CE(SAT)</sub>		0.15	0.3	V	I F = 10mA, I C = 1.0mA		
Breakdown Voltage								
Collector to Emitter	BV <sub>CEO</sub>	30			V	I CE = 100 μA, TA = 25 °C		
Collector to Base	BV <sub>CBO</sub>	70			V	I CB = 10 μA, TA = 25 °C		
Emitter to Collector	BV <sub>ECO</sub>	5			V	I EC = 100 μA, TA = 25 °C		
Leakage Current	I <sub>CEO</sub>			100	nA	VCE = 20V, TA = 25 °C		
Collector to Emitter				100	μA	VCE = 20V, TA = 100 °C		
Input Forward Voltage	V <sub>F</sub>	0.90	1.3	1.7	V	I F = 10mA	1	
Input Reverse Current	I <sub>R</sub>			100	μA	V R = 3.0V		
Input to Output Leakage Current	I <sub>I-O</sub>			1.0	μA	Relative Humidity ≤ 50% TA = 25 °C, V I - O = 1000 Vdc		1
Turn On Time	t <sub>ON</sub>		5	15	μS	VCC = 10V, RL = 100 Ω I C = 2mA, TA =25 °C	4,5	
Turn Off Time	t <sub>OFF</sub>		5	15	μS			

# TYPICAL PERFORMANCE CURVES

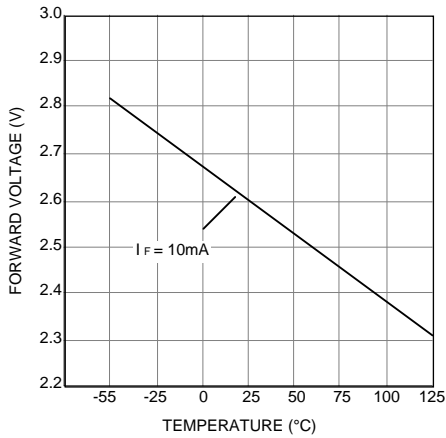

Fig. 1 - LED Forward Characteristics

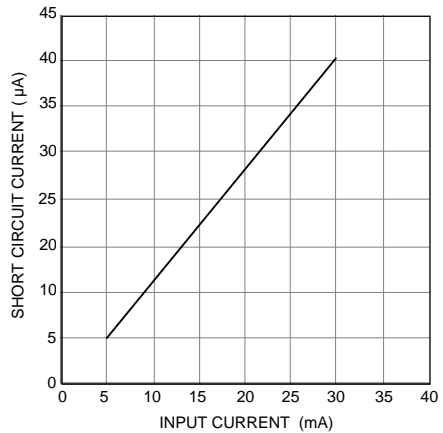

Fig. 2 - Input Current vs. Output Short-Circuit Current

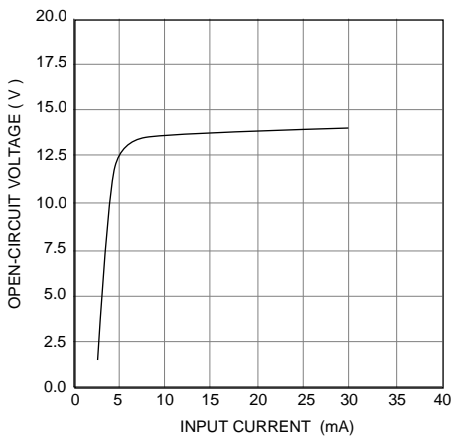

Fig. 3 - Input Current vs. Output Open-Circuit Voltage

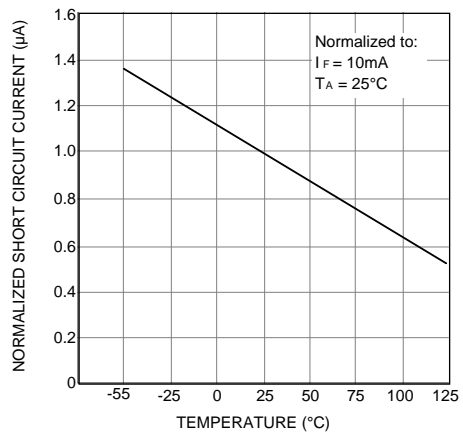

Fig. 4 - Normalized Short Circuit Current vs. Temperature

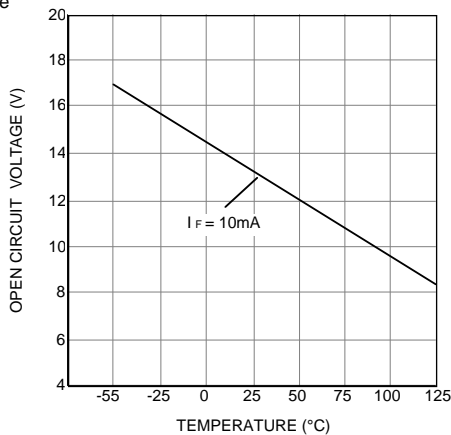

Fig. 5 - Open Circuit Voltage vs. Temperature