11.3-GBPS DIFFERENTIAL VCSEL DRIVER

FEATURES

- Up to 11.3-Gbps Operation
- Two-Wire Digital Interface
- Digitally Selectable Modulation Current up to 40 mA
- Digitally Selectable Bias Current up to 20 mA
- Automatic Power Control (APC) Loop
- Supports Transceiver Management System (TMS)
- Programmable Input Equalizer
- Includes Laser Safety Features
- Analog Temperature Sensor Output
- Single 3.3-V Supply
- Operating Temperature -40°C to 85°C
- Surface-Mount, Small-Footprint, 4-mm \times 4-mm, 20-Pin QFN Package

APPLICATIONS

- 10-Gigabit Ethernet Optical Transmitters
- 8 \times and 10 \times Fibre Channel Optical Transmitters
- SONET OC-192/SDH STM-64 Optical Transmitters
- XFP and SFP+ Transceiver Modules
- XENPAK, XPAK, X2, and 300-Pin MSA Transponder Modules

DESCRIPTION

The ONET1191V is a high-speed, 3.3-V laser driver designed to directly modulate VCSELs at data rates up to 11.3 Gbps.

The device provides a two-wire serial interface which allows digital control of the modulation and bias currents, eliminating the need for external components. An optional input equalizer can be used for equalization of up to 300 mm (12 inches) of microstrip or stripline transmission line on FR4 printed-circuit boards.

The ONET1191V includes an integrated automatic power control (APC) loop as well as circuitry to support laser safety and transceiver management systems.

The VCSEL driver is characterized for operation from -40°C to 85°C ambient temperatures and is available in a small-footprint, 4-mm \times 4-mm, 20-pin QFN package.



Please be aware that an important notice concerning availability, standard warranty, and use in critical applications of Texas Instruments semiconductor products and disclaimers thereto appears at the end of this data sheet.



These devices have limited built-in ESD protection. The leads should be shorted together or the device placed in conductive foam during storage or handling to prevent electrostatic damage to the MOS gates.

BLOCK DIAGRAM

A simplified block diagram of the ONET1191V is shown in Figure 1.

The VCSEL driver consists of an equalizer, a high-speed current modulator, a modulation current generator, power-on reset circuitry, a two-wire interface and control logic block, a bias current generator and automatic power control loop, and an analog reference block.

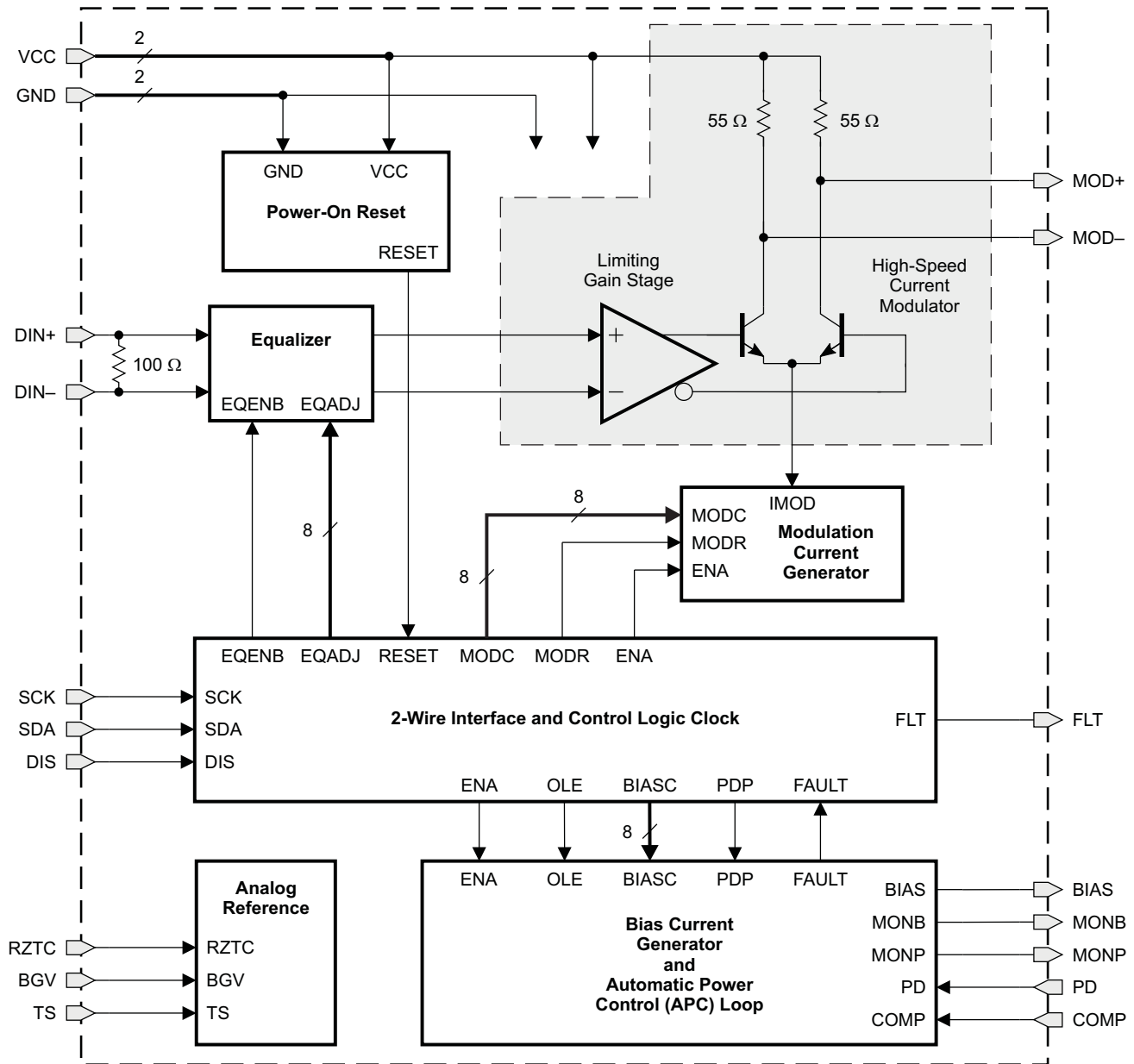

B0072-02

Figure 1. Simplified Block Diagram of the ONET1191V

EQUALIZER

The data signal can be applied to an input equalizer by means of the input signal pins DIN+/DIN–, which provide on-chip differential 100- Ω line termination. The equalizer is enabled by setting EQENB = 0 (bit 1 of register 0). Equalization of up to 300 mm (12 inches) of microstrip or stripline transmission line on FR4 printed circuit boards can be achieved. The amount of equalization is digitally controlled by the two-wire interface and control logic block and depends on the register settings EQADJ[0..7] (register 3). The equalizer can also be turned off and bypassed by setting EQENB = 1. For details about the equalizer settings, see [Table 6](#).

HIGH-SPEED CURRENT MODULATOR

The output of the equalizer is applied to the high-speed current modulator. The limiting gain stage ensures sufficient drive amplitude and edge speed for driving the current modulator differential pair.

The modulation current is sunk from the common-emitter node of the named differential pair by means of a modulation current generator, which is digitally controlled by the two-wire interface and control logic block.

The collector nodes of the differential pair are connected to the output pins MOD+/MOD–, which include on-chip $2 \times 55\text{-}\Omega$ back-termination to VCC. The 55- Ω back-termination helps to suppress signal distortion caused by double reflections for VCSEL diodes with impedances from 50 Ω through 75 Ω .

MODULATION CURRENT GENERATOR

The modulation current generator provides the current for the current modulator described previously. The circuit is digitally controlled by the two-wire interface and control logic block.

An 8-bit-wide control bus, MODC, is used to set the desired modulation current. Furthermore, two modulation current ranges are selected by means of the MODR signal. The ENA signal enables or disables the modulation current generator.

The modulation current can be disabled by setting the DIS input pin to a high level. The modulation current is also disabled in a fault condition if the fault detection enable register flag FLTEN is set.

For more information about the register functionality, see the register mapping description in [Table 6](#).

TWO-WIRE INTERFACE AND CONTROL LOGIC

The ONET1191V uses a two-wire serial interface for digital control. A simplified block diagram of this interface is shown in [Figure 2](#). The two circuit inputs, SDA and SCK, are driven, respectively, by the serial data and serial clock from a microcontroller, for example. Both inputs include 100-k Ω pullup resistors to VCC. For driving these inputs, an open-drain output is recommended.

A write cycle consists of a START command, three address bits with MSB first, 8 data bits with MSB first, and a STOP command. In idle mode, both the SDA and SCK lines are at a high level.

A START command is initiated by the falling edge of SDA with SCK at a high level, transitioning to a low level.

Bits are clocked into an 11-bit-wide shift register during the high level of the serial clock, SCK.

A STOP command is detected on the rising edge of SDA after SCK has changed from a low to a high level.

At the time of detection of a STOP command, the eight data bits from the shift register are copied to a selected 8-bit register. Register selection occurs according to the three address bits in the shift register, which are decoded to eight independent select signals using a 3-to-8 decoder block.

In the ONET1191V, addresses 0 (000b) through 3 (011b) are used.

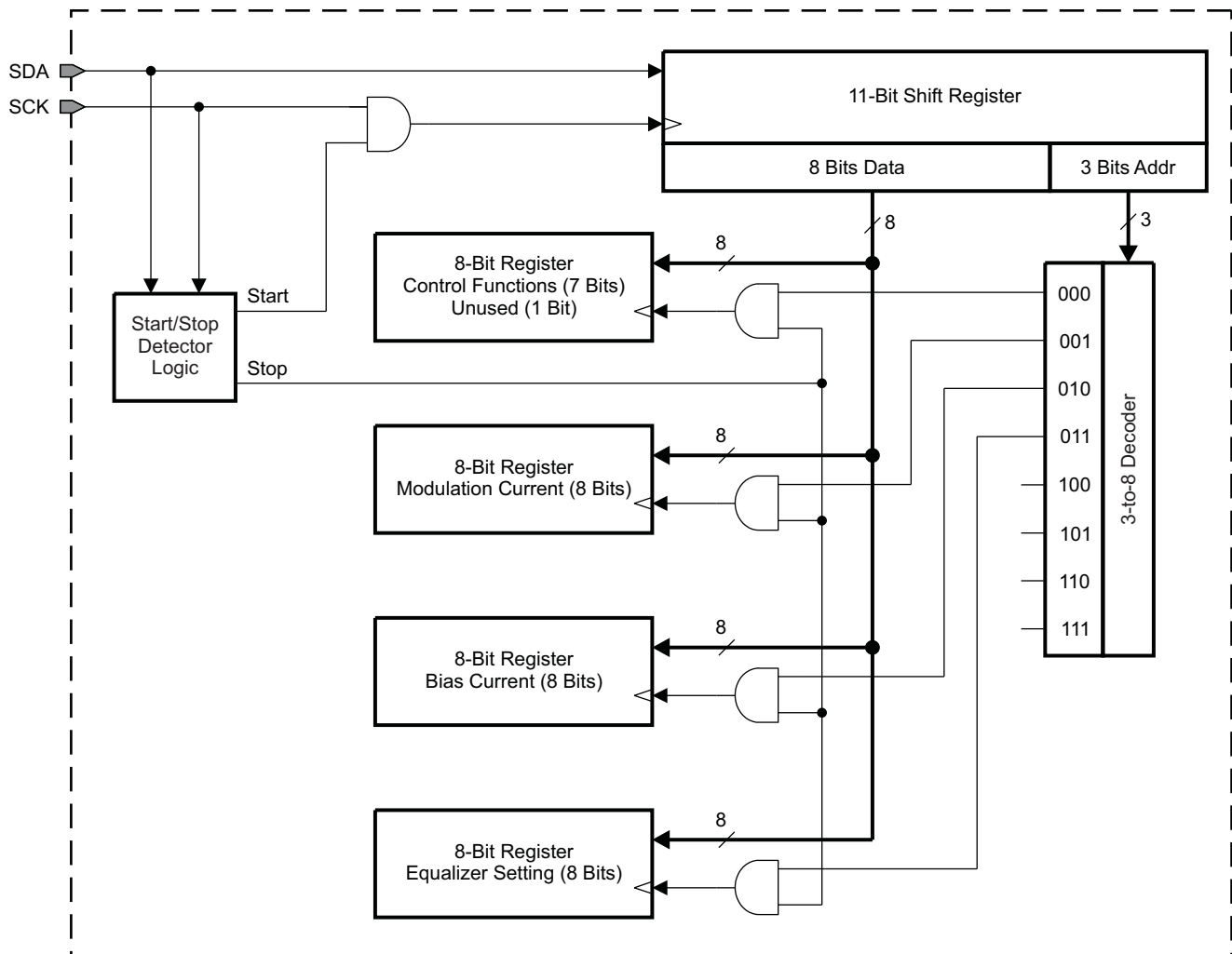

B0068-03

Figure 2. Simplified Two-Wire Interface Block Diagram

The timing definition for the serial data signal SDA and the serial clock signal SCK is shown in [Figure 3](#). The corresponding timing requirements are listed in [Table 1](#).

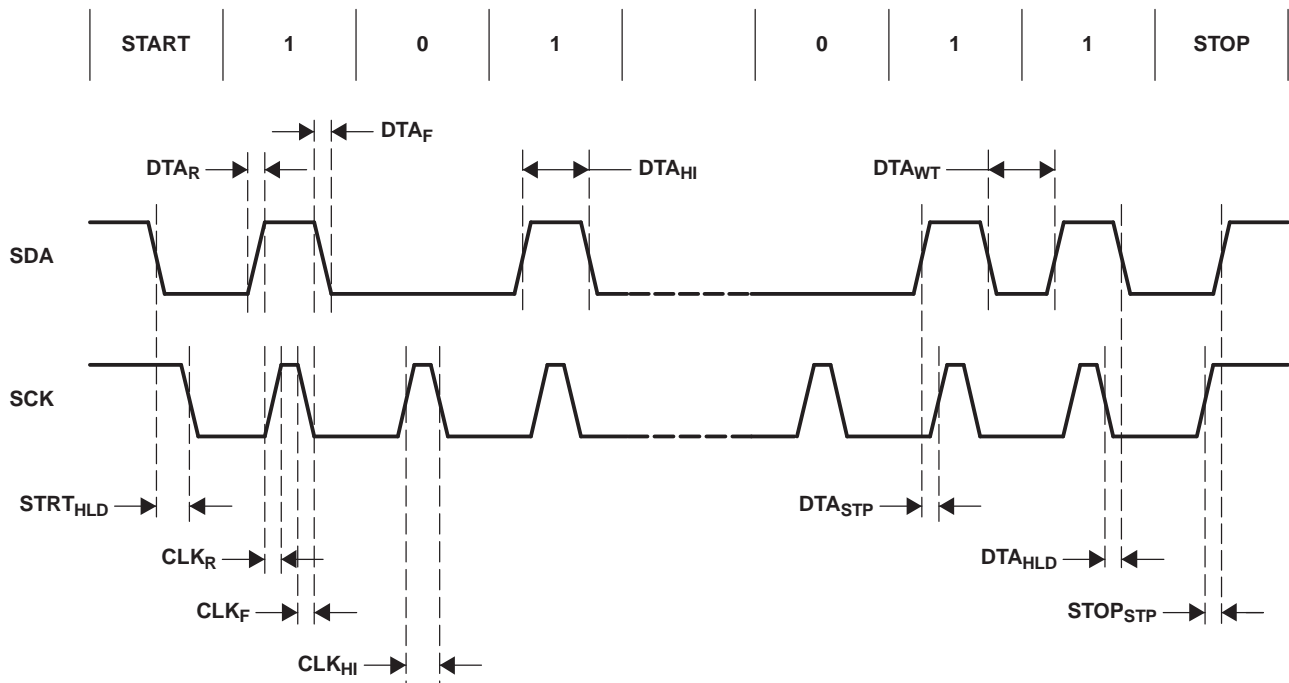

T0077-01

Figure 3. Two-Wire Interface Timing Diagram

Table 1. Two-Wire Interface Timing

PARAMETER		DESCRIPTION	MIN	MAX	UNIT
STRT _{HLD}	START hold time	Time required from data falling edge to clock falling edge at START	10		ns
CLK _R , DTA _R	Clock and data rise time	Clock and data rise time		10	ns
CLK _F , DTA _F	Clock and data fall time	Clock and data fall time		10	ns
CLK _{HI}	Clock high time	Minimum clock high period	50		ns
DTA _{HI}	Data high time	Minimum data high period	100		ns
DTA _{STP}	Data setup time	Minimum time from data rising edge to clock rising edge	10		ns
DTA _{WT}	Data wait time	Minimum time from data falling edge to data rising edge	50		ns
DTA _{HLD}	Data hold time	Minimum time from clock falling edge to data falling edge	10		ns
STOP _{STP}	STOP setup time	Minimum time from clock rising edge to data rising edge at STOP	10		ns

REGISTER MAPPING

The register mapping for the register addresses 0 (000b) through 3 (011b) are shown in [Table 2](#) through [Table 5](#). [Table 6](#) describes the circuit functionality based on the register settings.

Table 2. Register 0 (000b) Mapping

address 0 (000b)							
bit 7	bit 6	bit 5	bit 4	bit 3	bit 2	bit 1	bit 0
ENA	PDP	PDR	OLE	FLTEN	MODR	EQENB	–

Table 3. Register 1 (001b) Mapping

address 1 (001b)							
bit 7	bit 6	bit 5	bit 4	bit 3	bit 2	bit 1	bit 0
MODC7	MODC6	MODC5	MODC4	MODC3	MODC2	MODC1	MODC0

Table 4. Register 2 (010b) Mapping

address 2 (010b)							
bit 7	bit 6	bit 5	bit 4	bit 3	bit 2	bit 1	bit 0
BIASC7	BIASC6	BIASC5	BIASC4	BIASC3	BIASC2	BIASC1	BIASC0

Table 5. Register 3 (011b) Mapping

address 3 (011b)							
bit 7	bit 6	bit 5	bit 4	bit 3	bit 2	bit 1	bit 0
EQADJ7	EQADJ6	EQADJ5	EQADJ4	EQADJ3	EQADJ2	EQADJ1	EQADJ0

Table 6. Register Functionality

SYMBOL	REGISTER	FUNCTION
ENA	Enable	Enables chip when set to 1. Can be toggled low to reset a fault condition.
PDP	Photodiode polarity	Photodiode polarity bit: 1 = photodiode cathode connected to V _{CC} 0 = photodiode anode connected to GND
PDR	Photodiode current range	Photodiode current range bit: With coupling ratio CR between VCSEL bias current and photodiode current = 30 1 = 12 μA–640 μA with 2.5 μA resolution 0 = 2.5 μA–12 8μA with 0.5μA resolution
OLE	Open loop enable	Open-loop enable bit: 1 = open-loop bias current control 0 = closed-loop bias current control
FLTEN	Fault detection enable	Fault detection enable bit: 1 = fault detection on 0 = fault detection off
MODR	Modulation tail current range	Laser modulation tail current range: 1 = 0 mA–40 mA 0 = 0 mA–20 mA
EQENB	Equalizer enable	Equalizer enable bit 1 = equalizer disabled 0 = equalizer enabled
MODC7	Modulation current bit 7 (MSB)	Modulation current setting: MODR = 1: Modulation current up to 40 mA in 156-μA steps MODR = 0: Modulation current up to 20 mA in 78-μA steps
MODC6	Modulation current bit 6	
MODC5	Modulation current bit 5	
MODC4	Modulation current bit 4	
MODC3	Modulation current bit 3	
MODC2	Modulation current bit 2	
MODC1	Modulation current bit 1	
MODC0	Modulation current bit 0 (LSB)	
BIASC7	Bias current bit 7 (MSB)	Closed loop (APC): Coupling ratio $CR = I_{BIAS-VCSEL}/I_{PD}$ PDR = 0, BIASC = 0..255, $I_{BIAS-VCSEL} \leq 20$ mA: $I_{BIAS-VCSEL} = 0.5 \mu A \times CR \times BIASC$ PDR = 1, BIASC = 0..255, $I_{BIAS-VCSEL} \leq 20$ mA: $I_{BIAS-VCSEL} = 2.5 \mu A \times CR \times BIASC$ Open loop: $I_{BIAS-VCSEL} = 75 \mu A \times BIASC$
BIASC6	Bias current bit 6	
BIASC5	Bias current bit 5	
BIASC4	Bias current bit 4	
BIASC3	Bias current bit 3	
BIASC2	Bias current bit 2	
BIASC1	Bias current bit 1	
BIASC0	Bias current bit 0 (LSB)	
EQADJ7	Equalizer adjustment bit 7 (MSB)	Equalizer adjustment setting EQENB = 1 Equalizer is turned off and bypassed
EQADJ6	Equalizer adjustment bit 6	
EQADJ5	Equalizer adjustment bit 5	
EQADJ4	Equalizer adjustment bit 4	
EQADJ3	Equalizer adjustment bit 3	

Table 6. Register Functionality (continued)

SYMBOL	REGISTER	FUNCTION
EQADJ2	Equalizer adjustment bit 2	EQENB = 0
EQADJ1	Equalizer adjustment bit 1	Maximum equalization for 0000 0000
EQADJ0	Equalizer adjustment bit 0 (LSB)	Minimum equalization for 1111 1111

BIAS CURRENT GENERATION AND APC LOOP

The bias current generation and APC loop are controlled by means of the two-wire interface. In open-loop operation, selected by setting OLE = 1 (bit 4 of register 0), the bias current is set directly by the 8-bit-wide control word BIASC[0..7] (register 2). In automatic power control mode, selected by setting OLE = 0, the bias current depends on the register settings BIASC[0..7] and the coupling ratio (CR) between the VCSEL bias current and the photodiode current. $CR = I_{BIAS-VCSEL}/I_{PD}$.

Two photodiode current ranges can be selected by means of the PDR register (bit 5 of register 0). The photodiode range should be chosen to keep the laser bias control DAC close to the center of its range. This keeps the laser bias current setpoint resolution high and the loop settling time constant within specification.

For details regarding the bias current setting in open- as well as in closed-loop mode, see [Table 6](#).

In closed-loop mode, the photodiode polarity bit, PDP, must be set for common-anode or common-cathode configuration to ensure proper operation. In open-loop mode, if a photodiode is present, the photodiode polarity bit must be set to the opposite setting.

ANALOG REFERENCE

The ONET1191V VCSEL driver is supplied by a single 3.3-V $\pm 10\%$ supply voltage connected to the VCC pins. This voltage is referred to ground (GND).

On-chip bandgap voltage circuitry generates a reference voltage, independent of the supply voltage, from which all other internally required voltages and bias currents are derived.

An external zero-temperature-coefficient resistor must be connected from the RZTC pin of the device to ground (GND). This resistor is used to generate a precise, zero-TC current, which is required as a reference current for the on-chip DACs.

In order to minimize the module component count, the ONET1191V provides an on-chip temperature sensor. The output voltage of the temperature sensor is available at the TS pin.

The voltage is $V_{TS} = (8.2 \text{ mV}/^{\circ}\text{C} \times \text{TEMP}) + 1140 \text{ mV}$, with TEMP given in $^{\circ}\text{C}$.

Note that the voltage at TS is not buffered. As a result, TS can only drive capacitive loads.

POWER-ON RESET AND REGISTER LOADING SEQUENCE

The ONET1191V has power-on-reset circuitry, which ensures that all registers are reset to zero during startup. After the power-on to initialize time (t_{INIT1}), the internal registers are ready to be loaded. It is important that the registers are loaded in the following order:

1. Bias current register (register 2, 010b)
2. Modulation current register (register 1, 001b)
3. Control register (register 0, 000b)
4. Loading of equalizer register (register 3, 011b) is not required.

The part is ready to transmit data after the initialize to transmit time t_{INIT2} , assuming that the control register enable bit ENA is set to 1 and the disable pin DIS is low.

The ONET1191V can be disabled using either the ENA control register bit or the disable pin DIS. In both cases, the internal registers are not reset. After the disable pin DIS is set low and/or the enable bit ENA is set back to 1, the part returns to its prior output settings.

LASER SAFETY FEATURES AND FAULT RECOVERY PROCEDURE

The ONET1191V provides built-in laser safety features. The following fault conditions are detected:

- Voltage at MONB exceeds the voltage at RZTC (1.15V).
- Photodiode current exceeds 150% of its set value.
- Bias control DAC drops in value by more than 50% in one step.

If one or more fault conditions occur and the fault enable bit FLTEN is set to 1, the ONET1191V responds by:

- Setting the VCSEL bias current to zero
- Setting the modulation current to zero
- Asserting and latching the FLT pin

Fault recovery is performed by the following procedure:

1. The disable pin DIS and/or the enable control bit ENA are toggled for at least the fault latch reset time t_{RESET} .
2. The FLT pin deasserts while the disable pin DIS is asserted or the enable bit ENA is deasserted.
3. If the fault condition is no longer present, the part returns to normal operation with its prior output settings after the disable negate time t_{ON} .
4. If the fault condition is still present, FLT reasserts once DIS is set to a low level, and the part does not return to normal operation.

PACKAGE

The ONET1191V is packaged in a small-footprint, 4-mm × 4-mm, 20-pin QFN package with a lead pitch of 0,5 mm. The pinout is shown in Figure 4.

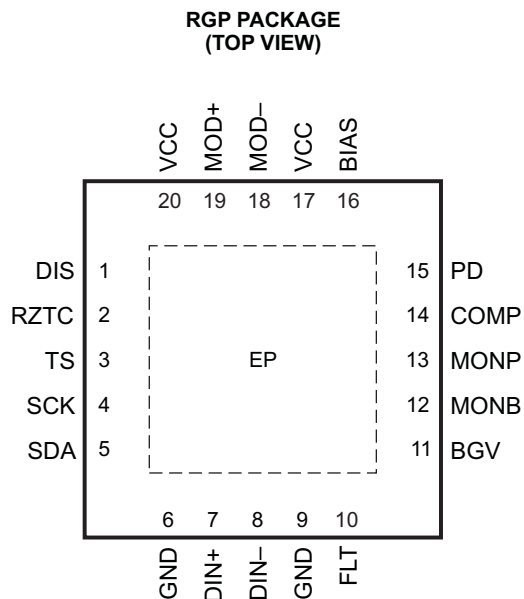

P0031-04

Figure 4. Pinout of ONET1191V in a 4-mm × 4-mm, 20-Pin QFN Package

TERMINAL FUNCTIONS

TERMINAL		I/O	DESCRIPTION
NAME	NO.		
BGV	11	Analog-out	Buffered bandgap voltage with open emitter output. This is a replica of the bandgap voltage at RZTC. For best matching, use the same 28.7-k Ω resistor to GND as used at RZTC.
BIAS	16	Analog	Sinks average bias current for VCSEL in both APC and open-loop modes. Connect to laser cathode through an inductor. BLM15HG102SN1D recommended.
COMP	14	Analog	Compensation pin used to control the bandwidth of the APC loop. Connect a 0.01- μ F capacitor to ground.
DIN+	7	Analog-in	Noninverted data input. On-chip differentially 100- Ω terminated to DIN-. Must be ac-coupled.
DIN-	8	Analog-in	Inverted data input. On-chip differentially 100- Ω terminated to DIN+. Must be ac-coupled.
DIS	1	Digital-in	Disables both bias and modulation currents when set to high state. Toggle to reset a fault condition.
FLT	10	Digital-out	Fault detection flag.
GND	6, 9, EP	Supply	Circuit ground. Exposed die pad (EP) must be grounded.
MOD+	19	CML-out	Noninverted modulation current output. On-chip, 55- Ω back-terminated to VCC.
MOD-	18	CML-out	Inverted modulation current output. On-chip, 55- Ω back-terminated to VCC.
MONB	12	Analog-out	Bias current monitor. Sources a 3.3% replica of the bias current. Connect an external resistor to ground (GND). If the voltage at this pin exceeds 1.15 V, a fault is triggered. Typically, choose a resistor to give MONB voltage of 0.8 V at the maximum desired bias current.
MONP	13	Analog-out	Photodiode current monitor. Sources a 50% replica of the photodiode current when PDR = 1 and a 250% replica when PDR = 0. Connect an external resistor (5 k Ω typical) to ground (GND).
PD	15	Analog	Photodiode input. Pin can source or sink current dependent on PDP register setting. PDP = 0: source; PDP = 1: sink. Pin supplies >1.5-V reverse bias.
RZTC	2	Analog	Connect external zero-TC, 28.7-k Ω resistor to ground (GND). Used to generate a defined zero-TC reference current for internal DACs.
SCK	4	Digital-in	Two-wire interface serial clock. Includes a 100-k Ω pullup resistor to VCC.
SDA	5	Digital-in	Two-wire interface serial data input. Includes a 100-k Ω pullup resistor to VCC.
TS	3	Analog-out	Temperature sensor output. Not buffered, capacitive load only.
VCC	17, 20	Supply	3.3-V \pm 10% supply voltage

ABSOLUTE MAXIMUM RATINGS⁽¹⁾

over operating free-air temperature range (unless otherwise noted)

		VALUE	UNIT
V_{CC}	Supply voltage ⁽²⁾	-0.3 to 4	V
V_{DIS} , V_{RZTC} , V_{TS} , V_{SCK} , V_{SDA} , V_{DIN+} , V_{DIN-} , V_{FLT} , V_{BGV} , V_{MONB} , V_{MONP} , V_{CAPC} , V_{PD} , V_{BIAS} , V_{MOD+} , V_{MOD-}	Voltage at DIS, RZTC, TS, SCK, SDA, DIN+, DIN-, FLT, BGV, MONB, MONP, CAPC, PD, BIAS, MOD+, MOD- ⁽²⁾	-0.3 to 4	V
ESD	ESD rating at all pins	2	kV (HBM)
$T_{J,max}$	Maximum junction temperature	125	$^{\circ}$ C
T_{stg}	Storage temperature range	-65 to 85	$^{\circ}$ C
T_A	Characterized free-air operating temperature range	-40 to 85	$^{\circ}$ C
T_{LEAD}	Lead temperature 1,6 mm (1/16 inch) from case for 10 seconds	260	$^{\circ}$ C

- (1) Stresses beyond those listed under *absolute maximum ratings* may cause permanent damage to the device. These are stress ratings only, and functional operation of the device at these or any other conditions beyond those indicated under *recommended operating conditions* is not implied. Exposure to absolute-maximum-rated conditions for extended periods may affect device reliability.
- (2) All voltage values are with respect to network ground terminal.

RECOMMENDED OPERATING CONDITIONS

			MIN	NOM	MAX	UNIT
V _{CC}	Supply voltage		2.9	3.3	3.6	V
V _{IH}	Digital input high voltage	DIS, SCK, SDA	2			V
V _{IL}	Digital input low voltage	DIS, SCK, SDA			0.8	V
	Bias output headroom voltage	V _{BIAS} – GND	300			mV
	Photodiode current range	Control bit PDR = 1, step size = 2.5 μA	12		640	μA
		Control bit PDR = 0 step size = 0.5 μA	2.5		128	
R _{RZTC}	Zero-TC resistor value ⁽¹⁾	1.15-V bandgap bias across resistor	28.4	28.7	29	kΩ
V _{IN}	Differential input voltage swing	Control bit EQENA = 1	200		1200	mVp-p
		Control bit EQENA = 0	500		1200	
t _{R-IN}	Input rise time	20%–80%		30	55	ps
t _{F-IN}	Input fall time	20%–80%		30	55	ps
T _A	Operating free-air temperature		–40		85	° C

(1) Changing the value alters the DAC ranges.

DC ELECTRICAL CHARACTERISTICS

Over recommended operating conditions; all values are for open-loop operation, $I_{\text{MODC}} = 12 \text{ mA}$, $I_{\text{BIASC}} = 6 \text{ mA}$, and $R_{\text{RTTC}} = 28.7 \text{ k}\Omega$ (unless otherwise noted)

PARAMETER		TEST CONDITIONS	MIN	TYP	MAX	UNIT
V_{CC}	Supply voltage		2.9	3.3	3.6	V
I_{VCC}	Supply current	$I_{\text{MODC}} = 24 \text{ mA}$, $I_{\text{BIASC}} = 6 \text{ mA}$, including I_{MODC} and I_{BIASC} , EQENB = 1		62	71	mA
		$I_{\text{MODC}} = 24 \text{ mA}$, $I_{\text{BIASC}} = 6 \text{ mA}$, including I_{MODC} and I_{BIASC} , EQENB = 0		70		
		Disabled, DIS = high and/or control bit ENA = low, EQENB = 1		35	42	
R_{IN}	Data input resistance	Differential between DIN+/DIN–	85	100	125	Ω
R_{OUT}	Data output resistance	Single-ended to V_{CC}	45	55	65	Ω
	Digital input current	SCK, SDA, 100-k Ω pullup to V_{CC} ⁽¹⁾	–50		10	μA
		DIS ⁽¹⁾	–10		10	μA
V_{OH}	Digital output high voltage	FLT, $I_{\text{SOURCE}} = 500 \mu\text{A}$	2.4			V
V_{OL}	Digital output low voltage	FLT, $I_{\text{SINK}} = 500 \mu\text{A}$			0.4	V
$I_{\text{BIAS-DIS}}$	Bias current during disable				100	μA
$I_{\text{BIAS-MIN}}$	Minimum bias current	See ⁽²⁾			0.2	mA
$I_{\text{BIAS-MAX}}$	Maximum bias current	DAC set to maximum, open- and closed-loop	14	20		mA
V_{PD}	Photodiode reverse bias voltage	APC active, $I_{\text{PD}} = \text{max}$	1.5	2.3		V
	Photodiode fault current level, percent of target I_{PD} ⁽¹⁾			150%		
V_{TS}	Temperature sensor voltage range	–40°C to 120°C junction temperature, capacitive load only, with midscale calibration. ⁽¹⁾	0.5		2.5	V
	Temperature sensor accuracy	With midscale calibration ⁽¹⁾		± 3		°C
I_{TS}	Temperature sensor drive current	Source or sink ⁽¹⁾	–1		1	μA
	Photodiode current monitor ratio	$I_{\text{MONP}}/I_{\text{PD}}$ with control bit PDR = 1	40%	50%	60%	
		$I_{\text{MONP}}/I_{\text{PD}}$ with control bit PDR = 0	200%	265%	300%	
Bias current monitor ratio	$I_{\text{MONB}}/I_{\text{BIAS}}$ (nominal 1/30 = 3.3%). 1.2-k Ω sense resistor	2.7%	3.3%	4%		
$V_{\text{CC-RST}}$	V_{CC} reset threshold voltage	V_{CC} voltage level which triggers power-on reset ⁽¹⁾	2.4	2.5	2.8	V
$V_{\text{CC-RSTHYS}}$	V_{CC} reset threshold voltage hysteresis			100 ⁽¹⁾		mV
$V_{\text{MONB-FLT}}$	Fault voltage at MONB	Fault occurs if voltage at MONB exceeds value	1.05	1.15	1.25	V

(1) Assured by simulation over process, supply, and temperature variation

(2) The bias current can be set below the specified minimum according to the corresponding register setting described in the register mapping section. However, in closed-loop operation, settings below the specified value may trigger a fault.

AC ELECTRICAL CHARACTERISTICS

Over recommended operating conditions with 50-Ω output load, open-loop operation, $I_{MODC} = 12\text{ mA}$, $I_{BIASC} = 6\text{ mA}$, and $R_{RZTC} = 28.7\text{ k}\Omega$, unless otherwise noted. Typical operating condition is at $V_{CC} = 3.3\text{ V}$ and $T_A = 25^\circ\text{C}$.

PARAMETER	TEST CONDITIONS	MIN	TYP	MAX	UNIT	
t_{r-OUT}	Output rise time	20%–80%, $t_{r-IN} < 40\text{ ps}$, 50-Ω load		20	30	ps
t_{f-OUT}	Output fall time	20%–80%, $t_{f-IN} < 40\text{ ps}$, 50-Ω load		25	30	ps
$I_{MOD-MAX}$	Maximum modulation current	Control bit MODR = 1, 50-Ω load		36	45	mA
		Control bit MODR = 0, 50-Ω load		18	27	
$I_{MOD-STEP}$	Modulation current step size	Control bit MODR = 1, 50-Ω load		175		μA
		Control bit MODR = 0, 50-Ω load		100		
DJ	Deterministic output jitter	Control bit EQENB = 1, K28.5 pattern at 11.3 Gbps		4	12	ps_{p-p}
		Control bit EQENB = 0, K28.5 pattern at 11.3 Gbps, maximum equalization with 300-mm FR4 trace		10	20	
RJ	Random output jitter	50-Ω load		0.5	0.8	ps_{RMS}
τ_{APC}	APC time constant	$C_{APC} = 0.01\text{ }\mu\text{F}$, $I_{PD} = 100\text{ }\mu\text{A}$, PD coupling ratio CR = 40 ⁽¹⁾		200		μs
t_{OFF}	Transmitter disable time	Rising edge of DIS to $I_{BIAS} \leq 0.1 \times I_{BIAS-NOMINAL}$ ⁽¹⁾		1	5	μs
t_{ON}	Disable negate time	Falling edge of DIS to $I_{BIAS} \geq 0.9 \times I_{BIAS-NOMINAL}$ ⁽¹⁾		1		ms
t_{INIT1}	Power-on to initialize	Power-on to registers ready to be loaded		1	10	ms
t_{INIT2}	Initialize to transmit	Register load STOP command to part ready to transmit valid data ⁽¹⁾		2		ms
t_{RESET}	DIS pulse duration	Time DIS must held high to reset part ⁽¹⁾		100		ns
t_{FAULT}	Fault assert time	Time from fault condition to FLT high ⁽¹⁾		50		μs

(1) Assured by simulation over process, supply, and temperature variation

TYPICAL CHARACTERISTICS

Typical operating condition is at $V_{CC} = 3.3\text{ V}$, $T_A = 25^\circ\text{C}$, $I_{BIASC} = 6\text{ mA}$, $I_{MODC} = 12\text{ mA}$, MODR = 0 (unless otherwise noted).

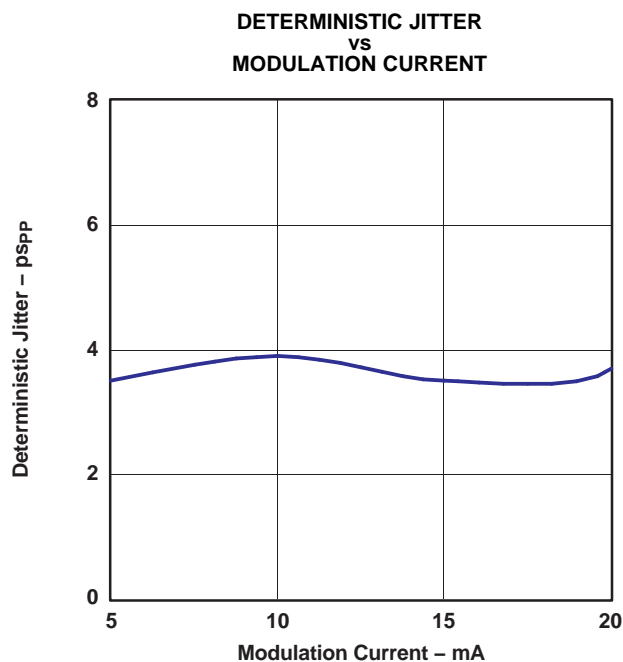

Figure 5.

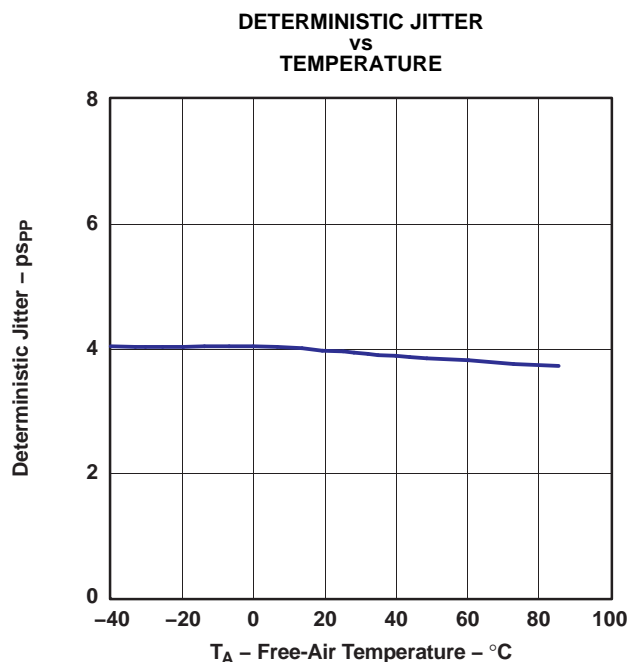

Figure 6.

TYPICAL CHARACTERISTICS (continued)

Typical operating condition is at $V_{CC} = 3.3\text{ V}$, $T_A = 25^\circ\text{C}$, $I_{BIASC} = 6\text{ mA}$, $I_{MODC} = 12\text{ mA}$, $MODR = 0$ (unless otherwise noted).

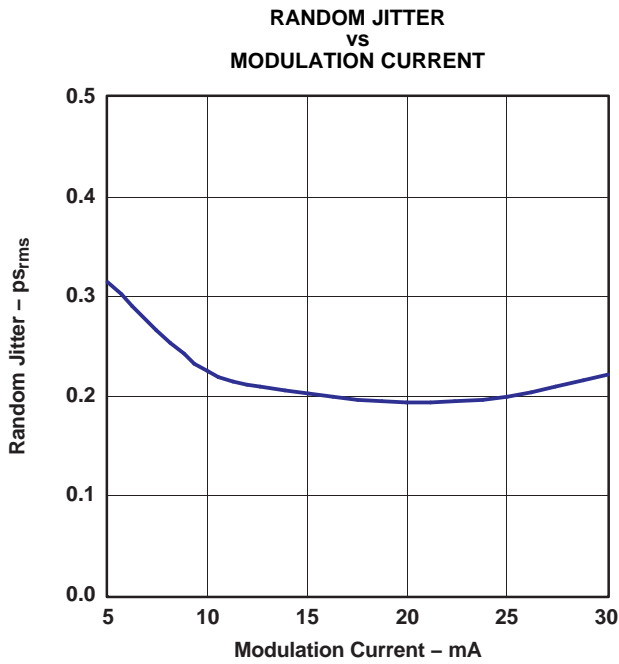

Figure 7.

G003

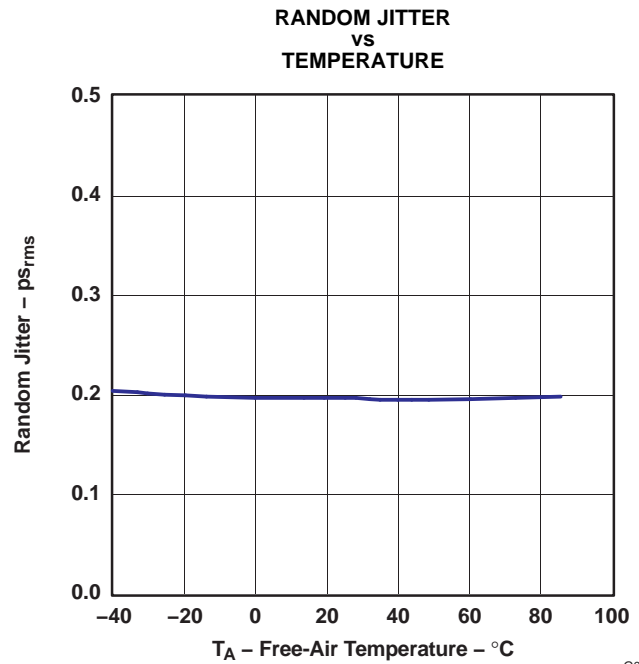

Figure 8.

G004

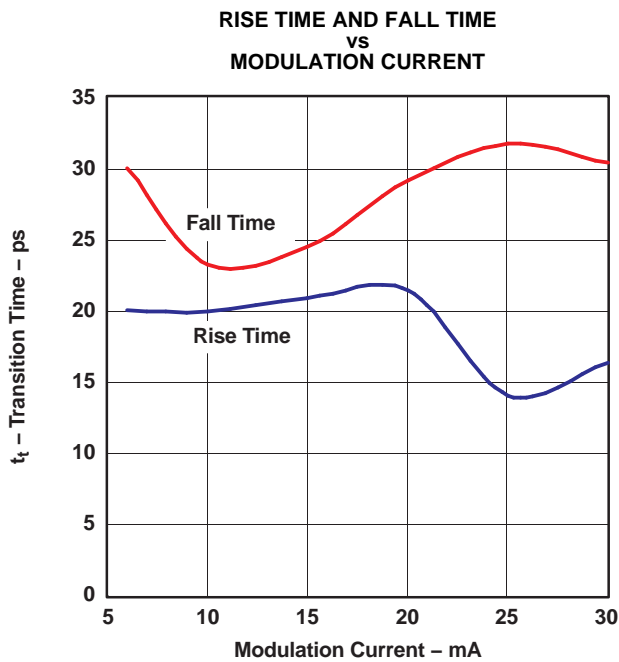

Figure 9.

G005

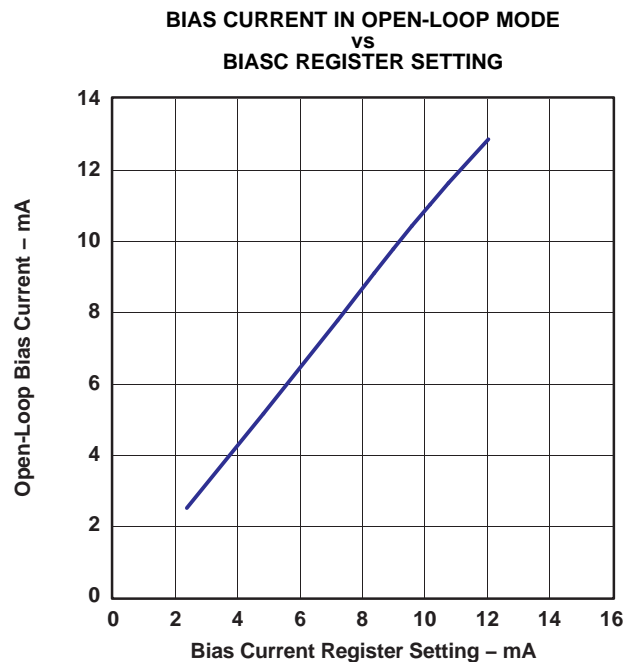

Figure 10.

G006

TYPICAL CHARACTERISTICS (continued)

Typical operating condition is at $V_{CC} = 3.3\text{ V}$, $T_A = 25^\circ\text{C}$, $I_{BIASC} = 6\text{ mA}$, $I_{MODC} = 12\text{ mA}$, $MODR = 0$ (unless otherwise noted).

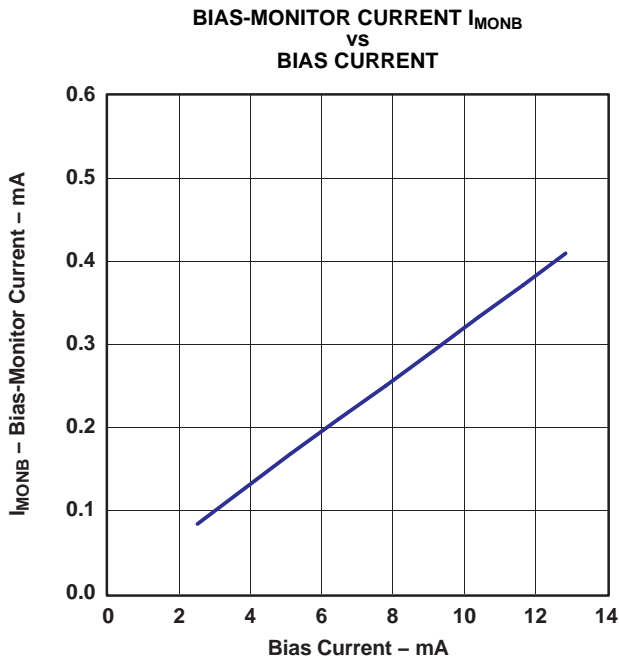

Figure 11.

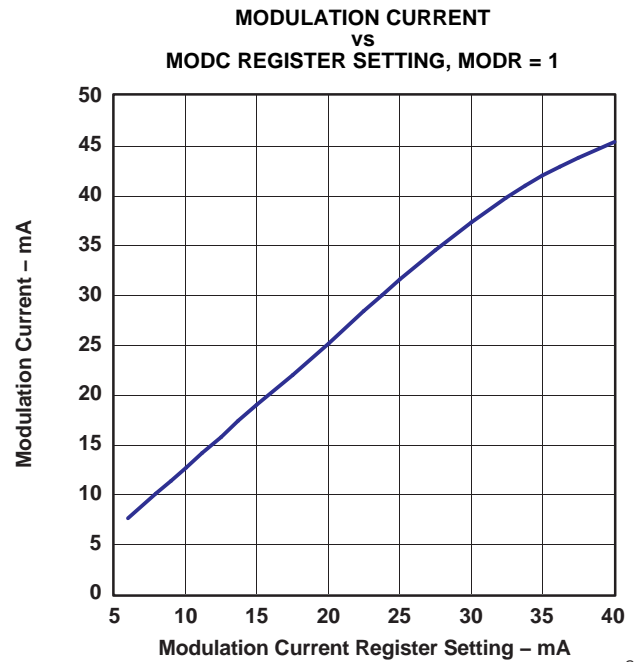

Figure 12.

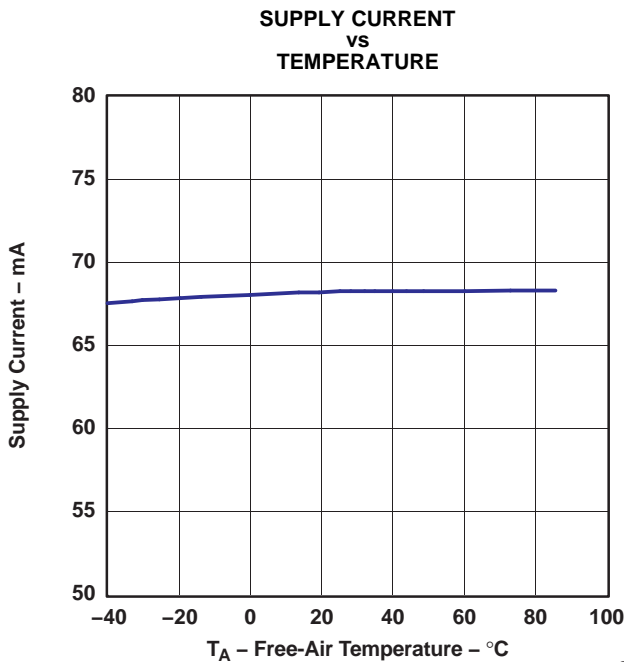

Figure 13.

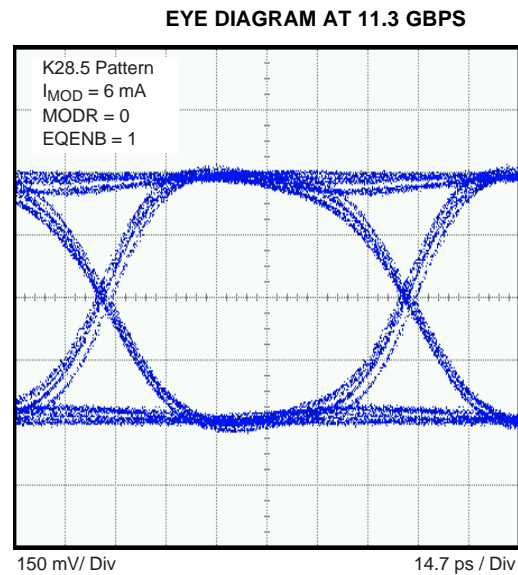
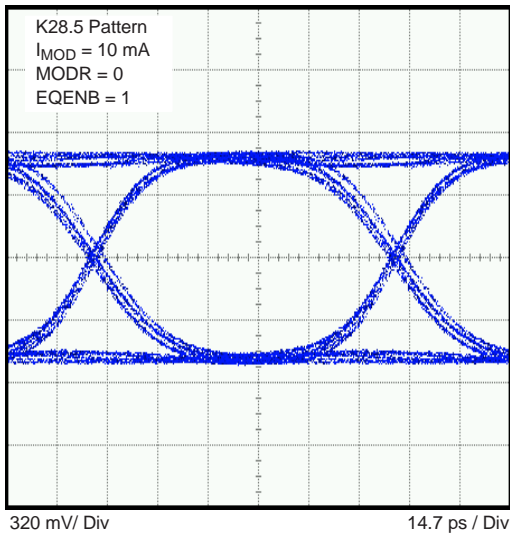

Figure 14.

TYPICAL CHARACTERISTICS (continued)

Typical operating condition is at $V_{CC} = 3.3\text{ V}$, $T_A = 25^\circ\text{C}$, $I_{BIASC} = 6\text{ mA}$, $I_{MODC} = 12\text{ mA}$, $MODR = 0$ (unless otherwise noted).

EYE DIAGRAM AT 11.3 GBPS



G010

Figure 15.

EYE DIAGRAM AT 11.3 GBPS

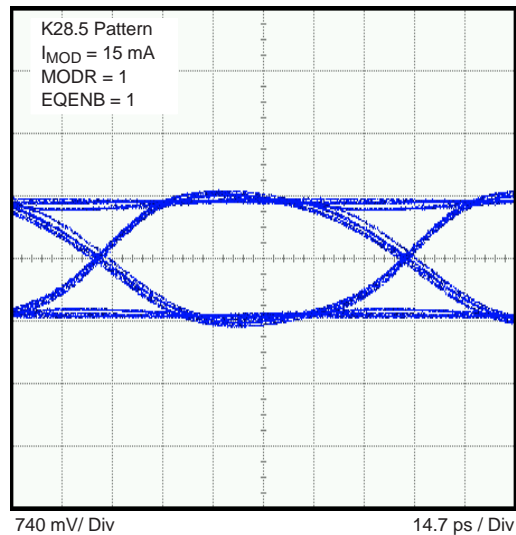

G011

Figure 16.

EYE DIAGRAM AT 8.5 GBPS

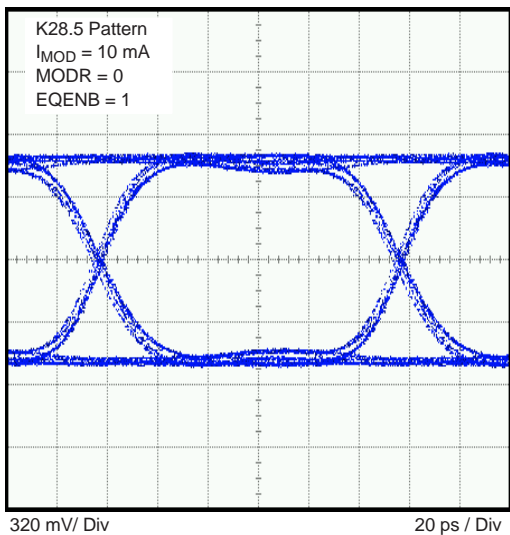

G012

Figure 17.

**EYE DIAGRAM AT 11.3 GBPS
12" OF FR4 AT INPUTS**

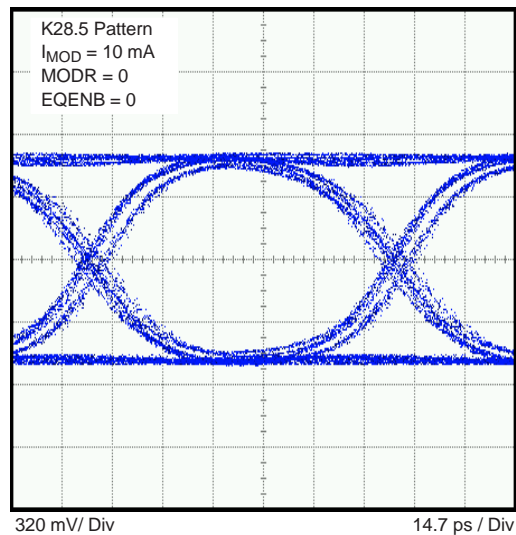

G013

Figure 18.

TYPICAL CHARACTERISTICS (continued)

Typical operating condition is at $V_{CC} = 3.3\text{ V}$, $T_A = 25^\circ\text{C}$, $I_{BIASC} = 6\text{ mA}$, $I_{MODC} = 12\text{ mA}$, $MODR = 0$ (unless otherwise noted).

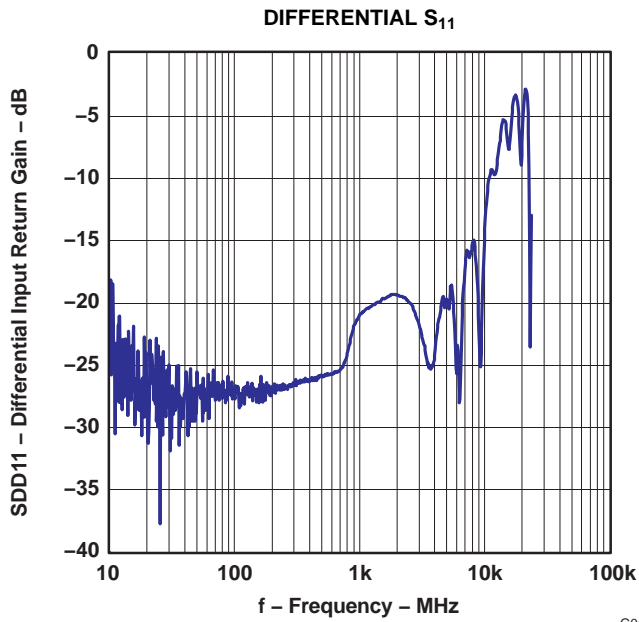

Figure 19.

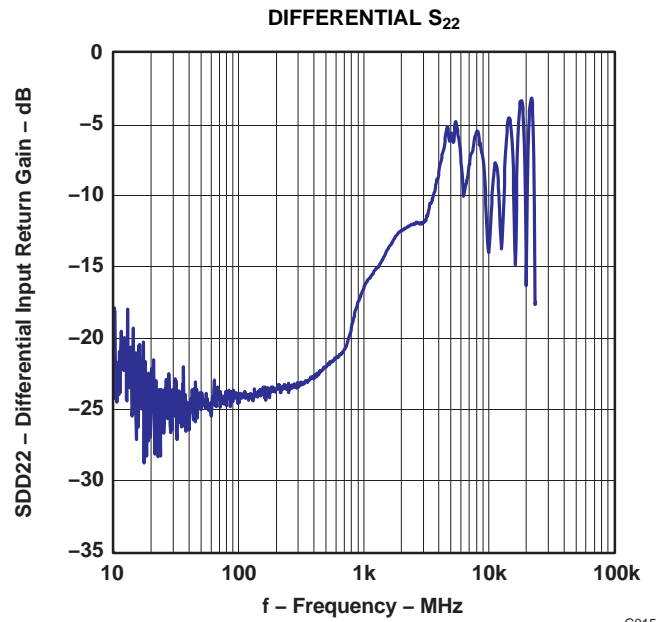
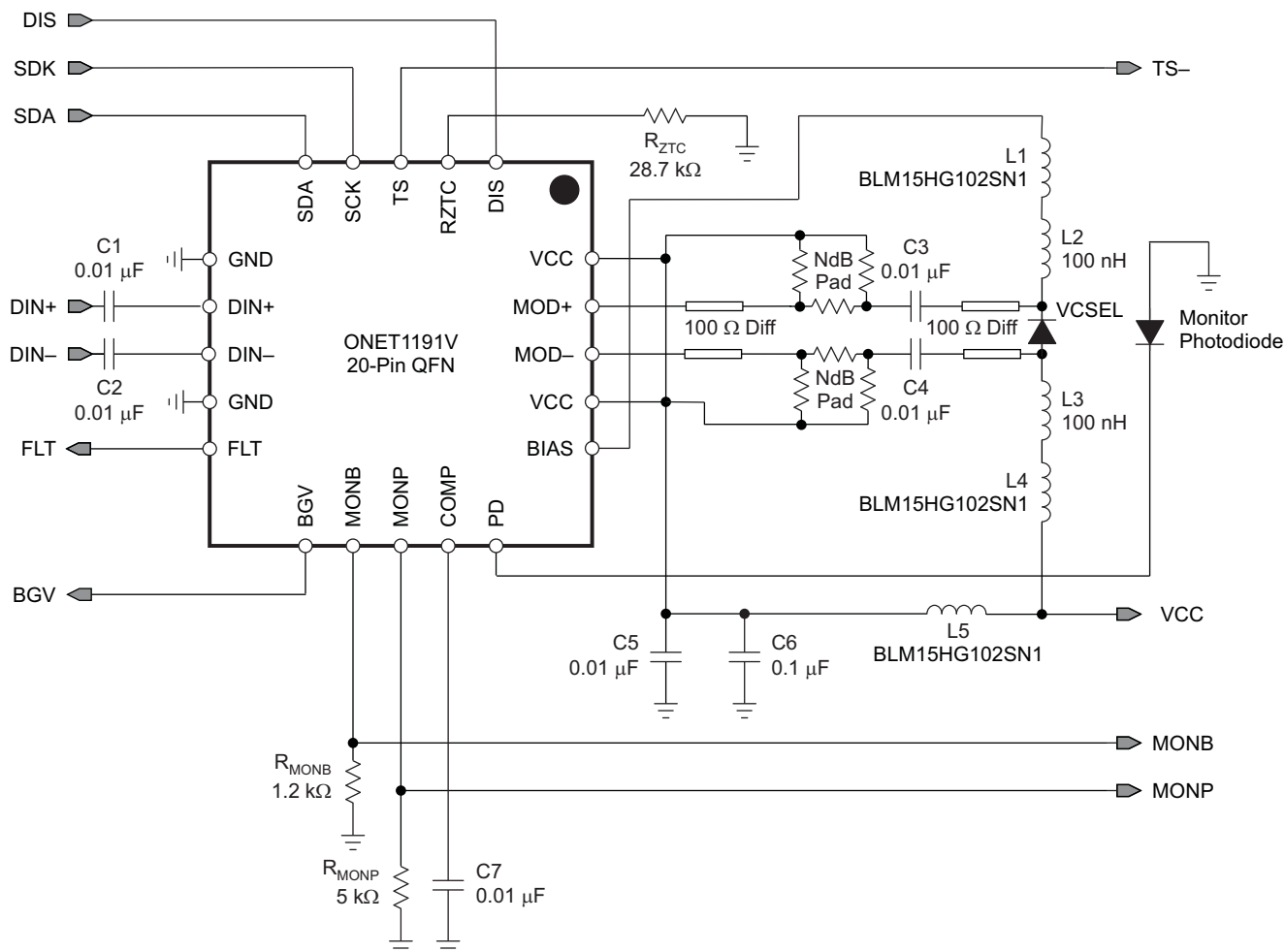

Figure 20.

APPLICATION INFORMATION

Figure 21 shows a typical application circuit using the ONET1191V with a common-cathode VCSEL, biased to V_{CC} , and driven differentially. The VCSEL driver is controlled via the two-wire interface SDA/SCK by a microprocessor. In a typical application, the FLT, MONP, MONB, and TS outputs are also connected to the microcontroller for transceiver management purposes. The monitor photodiode anode is grounded and the photodiode polarity bit, PDP, must be set to 0.

The component values in Figure 21 are typical examples and may be varied according to the intended application. For best performance, it is recommended to use differential drive. Single-ended VCSEL drive can be implemented by terminating the unused driver output in a resistance that matches the VCSEL series resistance; however, the available VCSEL modulation current is halved.



S0212-01

Figure 21. Typical Application Circuit With a Common Cathode VCSEL

In the recommended application circuit, the purpose of the attenuator pads is to improve the signal integrity between the VCSEL driver and the VCSEL. Because the VCSEL impedance is reactive, the pads attenuate reflections and provide a better matching impedance for the modulation current outputs. The disadvantage of using the attenuator pads is that the efficiency is reduced. That is, not all of the modulation current at the outputs of the VCSEL driver is available to drive the VCSEL. Table 7 lists the available modulation current at the VCSEL, I_{MOD} , depending on the modulation tail current register setting, I_{MODC} , the attenuator value, and the VCSEL series resistance. If care is taken in matching the output impedance of the ONET1191V to the impedance of the VCSEL, and if controlled-impedance transmission lines are used, attenuator pads may not be necessary.

Table 7. I_{MOD} vs I_{MODC} for a Given Attenuator Pad and VCSEL

I_{MODC} (mA): REGISTER SETTING	50- Ω PAD ATTENUATION (dB)	VCSEL SERIES RESISTANCE (Ω)	I_{MOD} (mA): MODULATION CURRENT AT THE VCSEL
40	3	100	14.76
40	6	100	10.52
30	3	100	11.07
30	6	100	7.89
20	3	100	7.38
20	6	100	5.26
40	3	60	18.33
40	6	60	13.12
30	3	60	13.75
30	6	60	9.84
20	3	60	9.17
20	6	60	6.56

LAYOUT GUIDELINES

For optimum performance, use 50- Ω transmission lines (100- Ω differential) for connecting the signal source to the DIN+ and DIN– pins and for connecting the modulation current outputs, MOD+ and MOD–, to the VCSEL. The length of the transmission lines should be kept as short as possible to reduce loss and pattern-dependent jitter.

THERMAL INFORMATION

This package incorporates an exposed thermal pad that is designed to be attached directly to an external heatsink. The thermal pad must be soldered directly to the printed circuit board (PCB). After soldering, the PCB can be used as a heatsink. In addition, through the use of thermal vias, the thermal pad can be attached directly to a ground or power plane (whichever is applicable), or alternatively, a special heatsink structure designed into the PCB. This design optimizes the heat transfer from the integrated circuit (IC).

For information on the Quad Flatpack No-Lead (QFN) package and its advantages, refer to Application Report, Quad Flatpack No-Lead Logic Packages, Texas Instruments Literature No. SCBA017. This document is available at www.ti.com.

The exposed thermal pad dimensions for this package are shown in the following illustration.

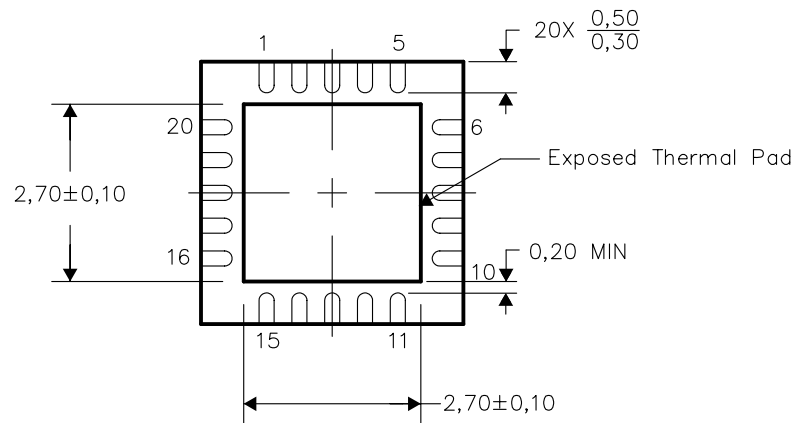

Bottom View

NOTE: All linear dimensions are in millimeters

Exposed Thermal Pad Dimensions

PACKAGING INFORMATION

Orderable Device	Status ⁽¹⁾	Package Type	Package Drawing	Pins	Package Qty	Eco Plan ⁽²⁾	Lead/Ball Finish	MSL Peak Temp ⁽³⁾
ONET1191VRGPR	ACTIVE	QFN	RGP	20	3000	Green (RoHS & no Sb/Br)	CU NIPDAU	Level-2-260C-1 YEAR
ONET1191VRGPRG4	ACTIVE	QFN	RGP	20	3000	Green (RoHS & no Sb/Br)	CU NIPDAU	Level-2-260C-1 YEAR
ONET1191VRGPT	ACTIVE	QFN	RGP	20	250	Green (RoHS & no Sb/Br)	CU NIPDAU	Level-2-260C-1 YEAR
ONET1191VRGPTG4	ACTIVE	QFN	RGP	20	250	Green (RoHS & no Sb/Br)	CU NIPDAU	Level-2-260C-1 YEAR

⁽¹⁾ The marketing status values are defined as follows:

ACTIVE: Product device recommended for new designs.

LIFEBUY: TI has announced that the device will be discontinued, and a lifetime-buy period is in effect.

NRND: Not recommended for new designs. Device is in production to support existing customers, but TI does not recommend using this part in a new design.

PREVIEW: Device has been announced but is not in production. Samples may or may not be available.

OBSOLETE: TI has discontinued the production of the device.

⁽²⁾ Eco Plan - The planned eco-friendly classification: Pb-Free (RoHS), Pb-Free (RoHS Exempt), or Green (RoHS & no Sb/Br) - please check <http://www.ti.com/productcontent> for the latest availability information and additional product content details.

TBD: The Pb-Free/Green conversion plan has not been defined.

Pb-Free (RoHS): TI's terms "Lead-Free" or "Pb-Free" mean semiconductor products that are compatible with the current RoHS requirements for all 6 substances, including the requirement that lead not exceed 0.1% by weight in homogeneous materials. Where designed to be soldered at high temperatures, TI Pb-Free products are suitable for use in specified lead-free processes.

Pb-Free (RoHS Exempt): This component has a RoHS exemption for either 1) lead-based flip-chip solder bumps used between the die and package, or 2) lead-based die adhesive used between the die and leadframe. The component is otherwise considered Pb-Free (RoHS compatible) as defined above.

Green (RoHS & no Sb/Br): TI defines "Green" to mean Pb-Free (RoHS compatible), and free of Bromine (Br) and Antimony (Sb) based flame retardants (Br or Sb do not exceed 0.1% by weight in homogeneous material)

⁽³⁾ MSL, Peak Temp. -- The Moisture Sensitivity Level rating according to the JEDEC industry standard classifications, and peak solder temperature.

Important Information and Disclaimer:The information provided on this page represents TI's knowledge and belief as of the date that it is provided. TI bases its knowledge and belief on information provided by third parties, and makes no representation or warranty as to the accuracy of such information. Efforts are underway to better integrate information from third parties. TI has taken and continues to take reasonable steps to provide representative and accurate information but may not have conducted destructive testing or chemical analysis on incoming materials and chemicals. TI and TI suppliers consider certain information to be proprietary, and thus CAS numbers and other limited information may not be available for release.

In no event shall TI's liability arising out of such information exceed the total purchase price of the TI part(s) at issue in this document sold by TI to Customer on an annual basis.

RGP (S-PQFP-N20)

PLASTIC QUAD FLATPACK

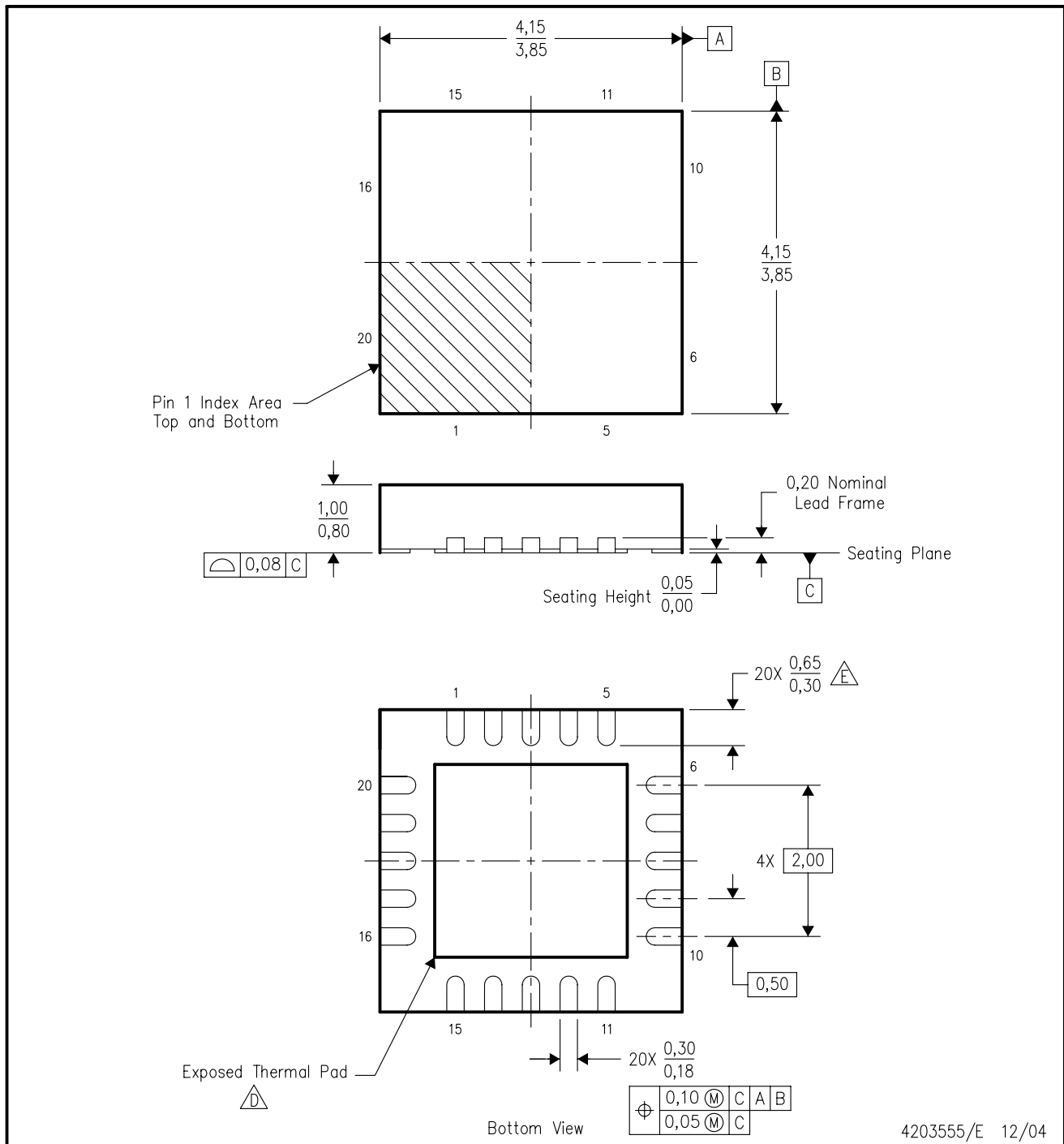

4203555/E 12/04

- NOTES:
- A. All linear dimensions are in millimeters. Dimensioning and tolerancing per ASME Y14.5M-1994.
 - B. This drawing is subject to change without notice.
 - C. QFN (Quad Flatpack No-Lead) package configuration.
 - D. The package thermal pad must be soldered to the board for thermal and mechanical performance. See the Product Data Sheet for details regarding the exposed thermal pad dimensions.
 - E. Check thermal pad mechanical drawing in the product datasheet for nominal lead length dimensions.

IMPORTANT NOTICE

Texas Instruments Incorporated and its subsidiaries (TI) reserve the right to make corrections, modifications, enhancements, improvements, and other changes to its products and services at any time and to discontinue any product or service without notice. Customers should obtain the latest relevant information before placing orders and should verify that such information is current and complete. All products are sold subject to TI's terms and conditions of sale supplied at the time of order acknowledgment.

TI warrants performance of its hardware products to the specifications applicable at the time of sale in accordance with TI's standard warranty. Testing and other quality control techniques are used to the extent TI deems necessary to support this warranty. Except where mandated by government requirements, testing of all parameters of each product is not necessarily performed.

TI assumes no liability for applications assistance or customer product design. Customers are responsible for their products and applications using TI components. To minimize the risks associated with customer products and applications, customers should provide adequate design and operating safeguards.

TI does not warrant or represent that any license, either express or implied, is granted under any TI patent right, copyright, mask work right, or other TI intellectual property right relating to any combination, machine, or process in which TI products or services are used. Information published by TI regarding third-party products or services does not constitute a license from TI to use such products or services or a warranty or endorsement thereof. Use of such information may require a license from a third party under the patents or other intellectual property of the third party, or a license from TI under the patents or other intellectual property of TI.

Reproduction of information in TI data books or data sheets is permissible only if reproduction is without alteration and is accompanied by all associated warranties, conditions, limitations, and notices. Reproduction of this information with alteration is an unfair and deceptive business practice. TI is not responsible or liable for such altered documentation.

Resale of TI products or services with statements different from or beyond the parameters stated by TI for that product or service voids all express and any implied warranties for the associated TI product or service and is an unfair and deceptive business practice. TI is not responsible or liable for any such statements.

Following are URLs where you can obtain information on other Texas Instruments products and application solutions:

Products		Applications	
Amplifiers	amplifier.ti.com	Audio	www.ti.com/audio
Data Converters	dataconverter.ti.com	Automotive	www.ti.com/automotive
DSP	dsp.ti.com	Broadband	www.ti.com/broadband
Interface	interface.ti.com	Digital Control	www.ti.com/digitalcontrol
Logic	logic.ti.com	Military	www.ti.com/military
Power Mgmt	power.ti.com	Optical Networking	www.ti.com/opticalnetwork
Microcontrollers	microcontroller.ti.com	Security	www.ti.com/security
Low Power Wireless	www.ti.com/lpw	Telephony	www.ti.com/telephony
		Video & Imaging	www.ti.com/video
		Wireless	www.ti.com/wireless

Mailing Address: Texas Instruments
Post Office Box 655303 Dallas, Texas 75265

Copyright © 2006, Texas Instruments Incorporated