

FEATURES

- **Excellent Individual Amplifier Parameters**
- **Low V_{OS}** **80 μ V Max**
- **Offset Voltage Match** **80 μ V Max**
- **Offset Voltage Match vs Temperature** **1 μ V/ $^{\circ}$ C Max**
- **Stable V_{OS} vs Time** **1 μ V/Mo Max**
- **Low Voltage Noise** **3.9nV/ $\sqrt{\text{Hz}}$ Max**
- **Fast** **2.8V/ μ s Typ**
- **High Gain** **1.8 Million Typ**
- **High Channel Separation** **154dB Typ**

ORDERING INFORMATION†

$T_A = 25^{\circ}\text{C}$ V_{OS} MAX (μV)	HERMETIC DIP 14-PIN	OPERATING TEMPERATURE RANGE
80	OP227AY*	MIL
80	OP227EY	IND
120	OP227BY/883	MIL
120	OP227FY	IND
180	OP227GY	IND

* For devices processed in total compliance to MIL-STD-883, add /883 after part number. Consult factory for 883 data sheet.

† Burn-in is available on commercial and industrial temperature range parts in CerDIP, plastic DIP, and TO-can packages.

GENERAL DESCRIPTION

The OP-227 is the first dual amplifier to offer a combination of low offset, low noise, high speed and guaranteed amplifier matching characteristics in one device. The OP-227 with a V_{OS} match of 25 μV typical, a TCV_{OS} match of 0.3 $\mu\text{V}/^{\circ}\text{C}$ typical, and a 1/f corner of only 2.7Hz is an excellent choice for precision low noise designs. These D.C. characteristics, coupled with a slew rate of 2.8V/ μs typical and a small-signal bandwidth of 8MHz typical, allow the designer to achieve AC performance previously unattainable with op-amp-based instrumentation designs.

SIMPLIFIED SCHEMATIC (1/2 OP-227)

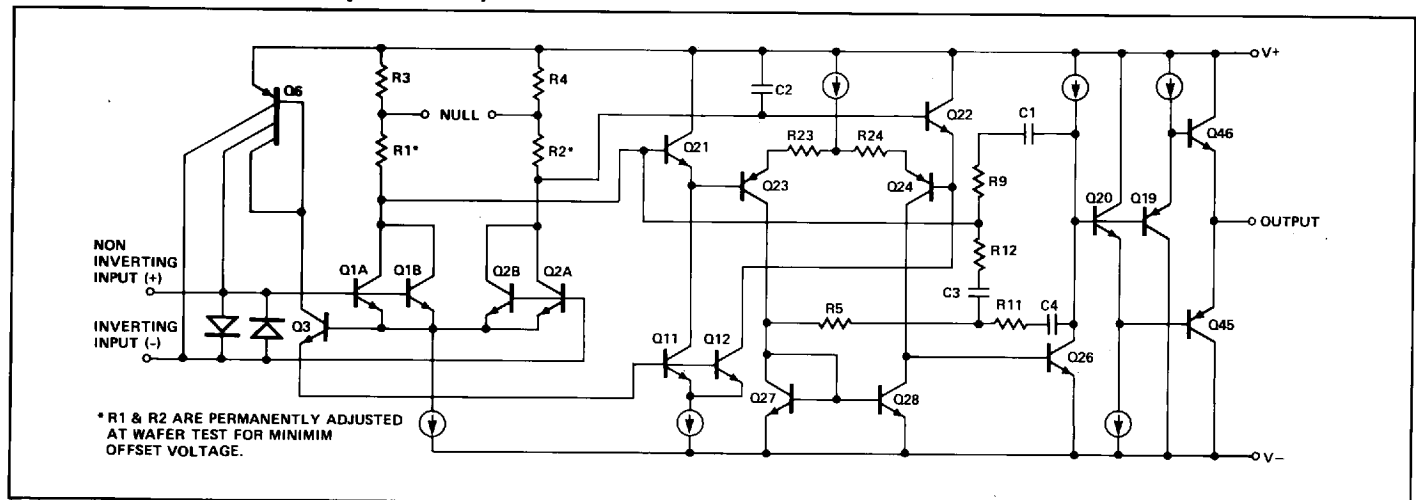

When used in a three-op-amp instrumentation amplifier configuration, the OP-227 can achieve a CMRR in excess of 100dB at 10kHz. In addition, this device has an open-loop gain of 1.5M typical with a 1k Ω load. The OP-227 also features an I_B of $\pm 10\text{nA}$ typical, an I_{OS} of 7nA typical, and guaranteed matching of input currents between amplifiers. These outstanding input current specifications are realized through the use of a unique input current-cancellation-circuit which typically holds I_B and I_{OS} to $\pm 20\text{nA}$ and 15nA respectively over the full military temperature range.

Other sources of input-referred errors, such as PSRR and CMRR, are reduced by factors in excess of 120dB for the individual amplifiers. D.C. stability is assured by a long-term drift specification of 1.0 $\mu\text{V}/\text{month}$.

Matching between channels is provided on all critical parameters including offset voltage, tracking of offset voltage vs. temperature, noninverting bias current, CMRR, and power supply rejection ratio. This unique dual amplifier allows the elimination of external components for offset nulling and frequency compensation.

The OP-227 is pin compatible with the OP-10 and OP-207.

PIN CONNECTIONS

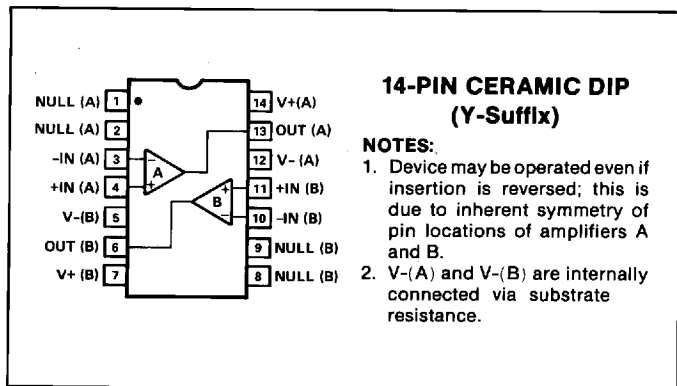

OP-227

ABSOLUTE MAXIMUM RATINGS

Supply Voltage	±22V
Input Voltage (Note 1)	±22V
Output Short-Circuit Duration	Indefinite
Differential Input Voltage (Note 2)	±0.7V
Differential Input Current (Note 2)	±25mA
Storage Temperature Range	-65°C to +150°C
Operating Temperature Range	
OP-227A, OP-227B	-55°C to +125°C
OP-227E, OP-227F, OP-227G	-25°C to +85°C
Lead Temperature (Soldering 60 sec)	300°C

PACKAGE TYPE	θ_{JA} (Note 3)	θ_{JC}	UNITS
14-Pin Hermetic DIP (Y)	108	16	°C/W

NOTES:

- For supply voltages less than ±22V, the absolute maximum input voltage is equal to the supply voltage.
- The OP-227's inputs are protected by back-to-back diodes. Current limiting resistors are not used in order to achieve low noise. If differential input voltage exceeds ±0.7V, the input current should be limited to 25mA.
- θ_{JA} is specified for worst case mounting conditions, i.e., θ_{JA} is specified for device in socket for CerDIP package.

INDIVIDUAL AMPLIFIER CHARACTERISTICS at $V_S = \pm 15V$, $T_A = 25^\circ C$, unless otherwise noted.

PARAMETER	SYMBOL	CONDITIONS	OP-227A/E			OP-227F			OP-227G			UNITS
			MIN	TYP	MAX	MIN	TYP	MAX	MIN	TYP	MAX	
Input Offset Voltage	V_{OS}	(Note 1)	—	20	80	—	40	120	—	60	180	μV
Long-Term V_{OS} Stability	V_{OS}/Time	(Notes 2, 4)	—	0.2	1.0	—	0.3	1.5	—	0.4	2.0	$\mu V/\text{Mo}$
Input Offset Current	I_{OS}		—	7	35	—	9	50	—	12	75	nA
Input Bias Current	I_B		—	±10	±40	—	±12	±55	—	±15	±80	nA
Input Noise Voltage	e_{np-p}	0.1Hz to 10Hz (Notes 3, 5)	—	0.08	0.20	—	0.08	0.20	—	0.09	0.28	μV_{p-p}
Input Noise Voltage Density	e_n	$f_O = 10\text{Hz}$ (Note 3)	—	3.5	6.0	—	3.5	6.0	—	3.8	9.0	$nV/\sqrt{\text{Hz}}$
		$f_O = 30\text{Hz}$ (Note 3)	—	3.1	4.7	—	3.1	4.7	—	3.3	5.9	
		$f_O = 1000\text{Hz}$ (Note 3)	—	3.0	3.9	—	3.0	3.9	—	3.2	4.6	
Input Noise Current Density	i_n	$f_O = 10\text{Hz}$ (Notes 3, 6)	—	1.7	4.5	—	1.7	4.5	—	1.7	—	$pA/\sqrt{\text{Hz}}$
		$f_O = 30\text{Hz}$ (Notes 3, 6)	—	1.0	2.5	—	1.0	2.5	—	1.0	—	
		$f_O = 1000\text{Hz}$ (Notes 3, 6)	—	0.4	0.7	—	0.4	0.7	—	0.4	0.7	
Input Resistance — Differential-Mode	R_{IN}	(Note 7)	1.3	6	—	0.94	5	—	0.7	4	—	M Ω
Input Resistance — Common-Mode	R_{INCM}		—	3	—	—	2.5	—	—	2	—	G Ω
Input Voltage Range	IVR		±11.0	±12.3	—	±11.0	±12.3	—	±11.0	±12.3	—	V
Common-Mode Rejection Ratio	CMRR	$V_{CM} = \pm 11V$	114	126	—	106	123	—	100	120	—	dB
Power Supply Rejection Ratio	PSRR	$V_S = \pm 4V$ to $\pm 18V$	—	1	10	—	1	10	—	2	20	$\mu V/V$
Large-Signal Voltage Gain	A_{VO}	$R_L \geq 2k\Omega$, $V_O = \pm 10V$	1000	1800	—	1000	1800	—	700	1500	—	V/mV
		$R_L \geq 600\Omega$, $V_O = \pm 10V$	800	1500	—	800	1500	—	600	1500	—	
Output Voltage Swing	V_O	$R_L \geq 2k\Omega$	±12.0	±13.8	—	±12.0	±13.8	—	±11.5	±13.5	—	V
		$R_L \geq 600\Omega$	±10.0	±11.5	—	±10.0	±11.5	—	±10.0	±11.5	—	
Slew Rate	SR	$R_L \geq 2k\Omega$ (Note 4)	1.7	2.8	—	1.7	2.8	—	1.7	2.8	—	V/ μs
Gain Bandwidth Prod.	GBW	(Note 4)	5	8	—	5	8	—	5	8	—	MHz
Open-Loop Output Resistance	R_O	$V_O = 0$, $I_O = 0$	—	70	—	—	70	—	—	70	—	Ω
Power Consumption	P_d	Each Amplifier	—	90	140	—	90	140	—	100	170	mW
Offset Adjustment Range		$R_P = 10k\Omega$	—	±4	—	—	±4	—	—	±4	—	mV

NOTES:

- Input offset voltage measurements are performed by automated test equipment approximately 0.5 seconds after application of power. A/E grade specifications are guaranteed fully warmed up.
- Long-Term Input Offset Voltage Stability refers to the average trend line of V_{OS} vs. Time over extended periods after the first 30 days of operation. Excluding the initial hour of operation, changes in V_{OS} during the first 30 days are typically $2.5\mu V$ — refer to typical performance curve.
- Sample tested.
- Parameter is guaranteed by design.
- See test circuit and frequency response curve for 0.1Hz to 10Hz tester.
- See test circuit for current noise measurement.
- Guaranteed by input bias current.

INDIVIDUAL AMPLIFIER CHARACTERISTICS for $V_S = \pm 15V$, $-55^\circ C \leq T_A \leq +125^\circ C$, unless otherwise noted.

PARAMETER	SYMBOL	CONDITIONS	OP-227A			UNITS
			MIN	TYP	MAX	
Input Offset Voltage	V_{OS}	(Note 1)	—	60	180	μV
Average Input Offset Drift	TCV_{OS} TCV_{OSn}	(Notes 2, 3)	—	0.3	1.0	$\mu V/^\circ C$
Input Offset Current	I_{OS}		—	15	50	nA
Input Bias Current	I_B		—	± 20	± 60	nA
Input Voltage Range	IVR		± 10.0	± 11.5	—	V
Common-Mode Rejection Ratio	CMRR	$V_{CM} = \pm 10V$	108	122	—	dB
Power Supply Rejection Ratio	PSRR	$V_S = \pm 4.5V$ to $\pm 18V$	—	2	16	$\mu V/V$
Large-Signal Voltage Gain	A_{VO}	$R_L \geq 2k\Omega$, $V_O = \pm 10V$	600	1200	—	V
Output Voltage Swing	V_O	$R_L \geq 2k\Omega$	± 11.5	± 13.5	—	V

INDIVIDUAL AMPLIFIER CHARACTERISTICS for $V_S = \pm 15V$, $-25^\circ C \leq T_A \leq 85^\circ C$, unless otherwise noted.

PARAMETER	SYMBOL	CONDITIONS	OP-227E			OP-227F			OP-227G			UNITS
			MIN	TYP	MAX	MIN	TYP	MAX	MIN	TYP	MAX	
Input Offset Voltage	V_{OS}	(Note 1)	—	40	140	—	60	200	—	85	280	μV
Average Input Offset Drift	TCV_{OS} TCV_{OSn}	(Note 2)	—	0.5	1.0	—	0.4	1.5	—	0.5	1.8	$\mu V/^\circ C$
Input Offset Current	I_{OS}		—	10	50	—	14	85	—	20	135	nA
Input Bias Current	I_B		—	± 14	± 60	—	± 18	± 95	—	± 25	± 150	nA
Input Voltage Range	IVR		± 10.0	± 11.8	—	± 10.0	± 11.8	—	± 10.0	± 11.8	—	V
Common-Mode Rejection Ratio	CMRR	$V_{CM} = \pm 10V$	110	124	—	102	121	—	96	118	—	dB
Power Supply Rejection Ratio	PSRR	$V_S = \pm 4.5V$ to $\pm 18V$	—	2	15	—	2	16	—	2	32	$\mu V/V$
Large-Signal Voltage Gain	A_{VO}	$R_L \geq 2k\Omega$, $V_O = \pm 10V$	750	1500	—	700	1300	—	450	1000	—	V/mV
Output Voltage Swing	V_O	$R_L \geq 2k\Omega$	± 11.7	± 13.6	—	± 11.4	± 13.5	—	± 11.0	± 13.3	—	V

MATCHING CHARACTERISTICS for $V_S = \pm 15V$, $T_A = 25^\circ C$, unless otherwise noted.

PARAMETER	SYMBOL	CONDITIONS	OP-227A/E			OP-227F			OP-227G			UNITS
			MIN	TYP	MAX	MIN	TYP	MAX	MIN	TYP	MAX	
Input Offset Voltage Match	ΔV_{OS}		—	25	80	—	35	150	—	55	300	μV
Average Noninverting Bias Current	I_{B^+}	$I_{B^+} = \frac{I_{B^+A} + I_{B^+B}}{2}$	—	± 10	± 40	—	± 12	± 55	—	± 15	± 90	nA
Noninverting Offset Current	I_{OS^+}	$I_{OS^+} = I_{B^+A} - I_{B^+B}$	—	± 12	± 60	—	± 15	± 80	—	± 20	± 130	nA
Inverting Offset Current	I_{OS^-}	$I_{OS^-} = I_{B^-A} - I_{B^-B}$	—	± 12	± 60	—	± 15	± 80	—	± 20	± 130	nA
Common-Mode Rejection Ratio Match	$\Delta CMRR$	$V_{CM} = \pm 11V$	110	123	—	103	120	—	97	117	—	dB
Power Supply Rejection Ratio Match	$\Delta PSRR$	$V_S = \pm 4V$ to $\pm 18V$	—	2	10	—	2	10	—	2	20	$\mu V/V$
Channel Separation	CS	(Note 1)	126	154	—	126	154	—	126	154	—	dB

NOTES:

- Input Offset Voltage measurements are performed by automated test equipment approximately 0.5 seconds after application of power.
- The TCV_{OS} performance is within the specifications unnullled or when nullled with $R_P = 8k\Omega$ to $20k\Omega$, optimum performance is obtained with $R_P = 8k\Omega$.
- Sample tested.

OP-227

MATCHING CHARACTERISTICS for $V_S = \pm 15V$, $T_A = -55^\circ C$ to $+125^\circ C$, unless otherwise noted.

PARAMETER	SYMBOL	CONDITIONS	OP-227A			UNITS
			MIN	TYP	MAX	
Input Offset Voltage Match	ΔV_{OS}		—	55	180	μV
Input Offset Voltage Tracking	$TC\Delta V_{OS}$	Nulled or Unnulled (Note 2)	—	0.3	1.0	$\mu V/^\circ C$
Average Noninverting Bias Current	I_{B^+}	$I_{B^+} = \frac{I_{B^+A} + I_{B^+B}}{2}$	—	± 20	± 60	nA
Average Drift of Non-inverting Bias Current	TCI_{B^+}		—	100	—	$\mu A/^\circ C$
Noninverting Offset Current	I_{OS^+}	$I_{OS^+} = I_{B^+A} - I_{B^+B}$	—	± 25	± 90	nA
Average Drift of Non-inverting Offset Current	TCI_{OS^+}		—	130	—	$\mu A/^\circ C$
Inverting Offset Current	I_{OS^-}	$I_{OS^-} = I_{B^-A} - I_{B^-B}$	—	± 25	± 90	nA
Common-Mode Rejection Ratio Match	$\Delta CMRR$	$V_{CM} = \pm 10V$	105	118	—	dB
Power Supply Rejection Ratio Match	$\Delta PSRR$	$V_S = \pm 4.5V$ to $\pm 18V$	—	2	16	$\mu V/V$

MATCHING CHARACTERISTICS for $V_S = \pm 15V$, $T_A = -25^\circ C$ to $+85^\circ C$, unless otherwise noted.

PARAMETER	SYMBOL	CONDITIONS	OP-227E			OP-227F			OP-227G			UNITS
			MIN	TYP	MAX	MIN	TYP	MAX	MIN	TYP	MAX	
Input Offset Voltage Match	ΔV_{OS}		—	40	140	—	65	210	—	90	400	μV
Input Offset Voltage Tracking	$TC\Delta V_{OS}$	Nulled or Unnulled (Note 1)	—	0.3	1.0	—	0.4	1.5	—	0.5	1.8	$\mu V/^\circ C$
Average Noninverting Bias Current	I_{B^+}	$I_{B^+} = \frac{I_{B^+A} + I_{B^+B}}{2}$	—	± 14	± 60	—	± 18	± 95	—	± 25	± 170	nA
Average Drift of Non-inverting Bias Current	TCI_{B^+}		—	80	—	—	140	—	—	180	—	$\mu A/^\circ C$
Noninverting Offset Current	I_{OS^+}	$I_{OS^+} = I_{B^+A} - I_{B^+B}$	—	± 20	± 90	—	± 25	± 140	—	± 35	± 250	nA
Average Drift of Non-inverting Offset Current	TCI_{OS^+}		—	130	—	—	200	—	—	250	—	$\mu A/^\circ C$
Inverting Offset Current	I_{OS^-}	$I_{OS^-} = I_{B^-A} - I_{B^-B}$	—	± 20	± 90	—	± 25	± 140	—	± 35	± 250	nA
Common-Mode Rejection Ratio Match	$\Delta CMRR$	$V_{CM} = \pm 10V$	106	120	—	98	117	—	90	112	—	dB
Power Supply Rejection Ratio Match	$\Delta PSRR$	$V_S = \pm 4.5V$ to $\pm 18V$	—	2	15	—	2	16	—	3	32	$\mu V/V$

NOTES:

1. Sample tested.
2. Guaranteed by design.

TYPICAL PERFORMANCE CHARACTERISTICS

VOLTAGE NOISE TEST CIRCUIT (0.1Hz-TO-10Hz_{p-p})

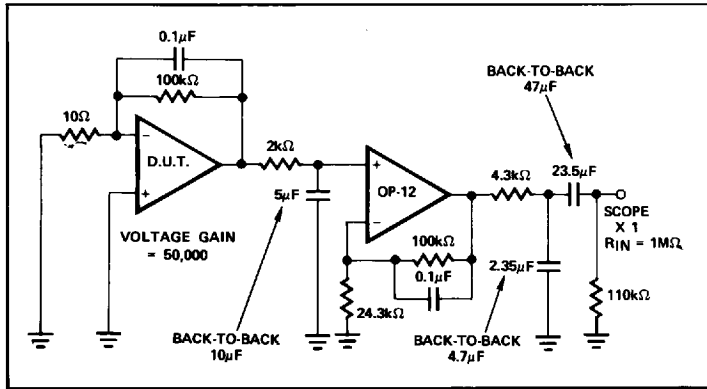

LOW-FREQUENCY NOISE

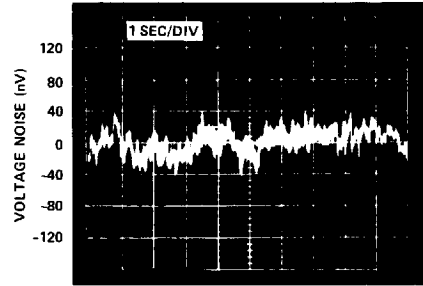

0.1Hz TO 10Hz PEAK-TO-PEAK NOISE

NOTE: OBSERVATION TIME MUST BE LIMITED TO 10 SECONDS TO ENSURE 0.1Hz CUTOFF.

VOLTAGE NOISE DENSITY vs FREQUENCY

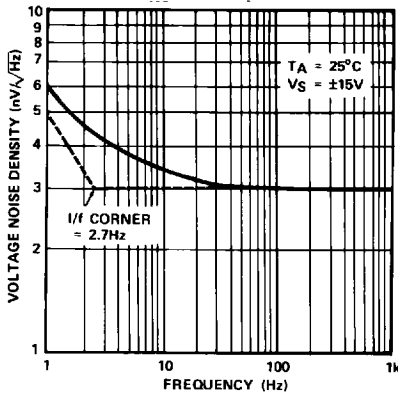

COMPARISON OF OP-AMP VOLTAGE NOISE SPECTRA

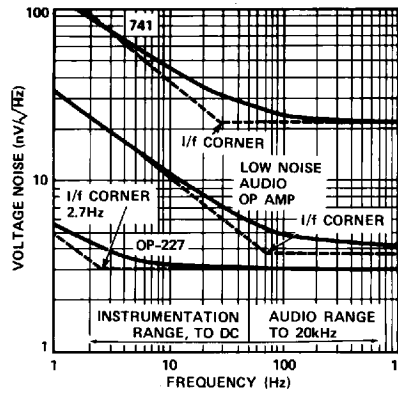

INPUT WIDEBAND NOISE vs BANDWIDTH (0.1Hz TO FREQUENCY INDICATED)

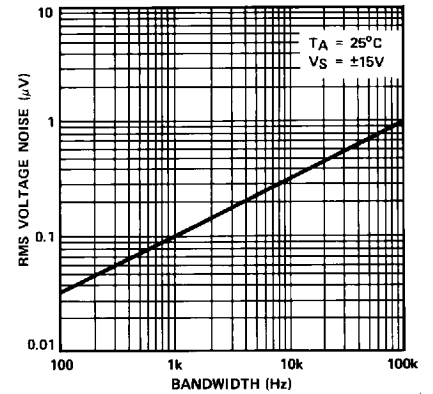

TOTAL NOISE vs SOURCE RESISTANCE

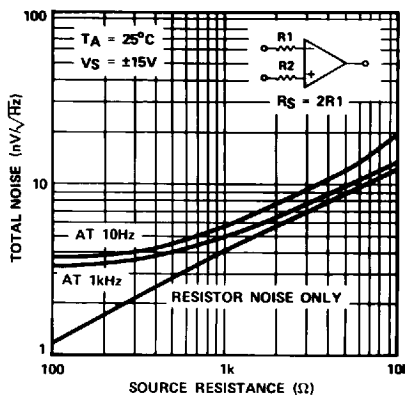

VOLTAGE NOISE DENSITY vs TEMPERATURE

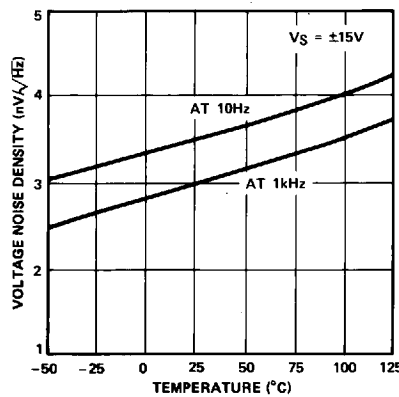

CURRENT NOISE DENSITY vs FREQUENCY

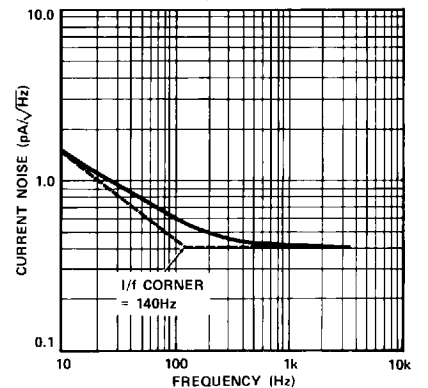

OP-227

TYPICAL PERFORMANCE CHARACTERISTICS

SUPPLY CURRENT vs SUPPLY VOLTAGE

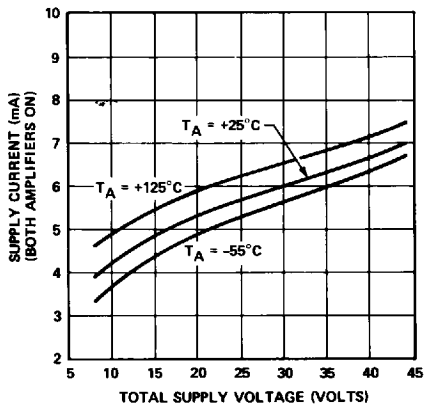

OFFSET VOLTAGE DRIFT OF REPRESENTATIVE UNITS

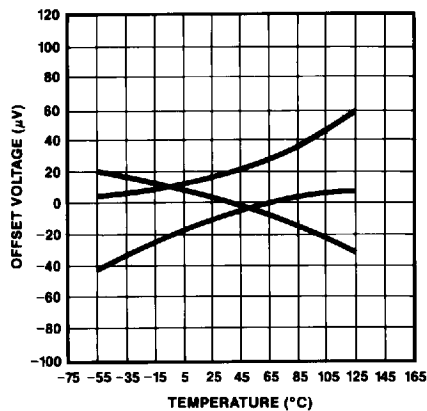

OFFSET VOLTAGE STABILITY WITH TIME

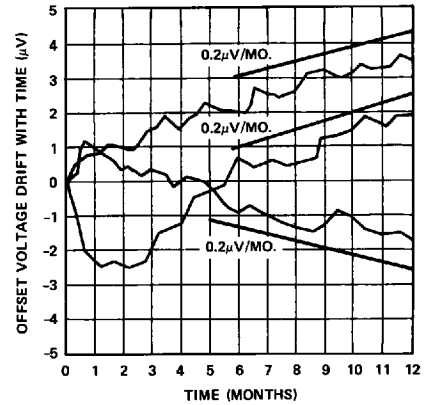

WARM-UP DRIFT

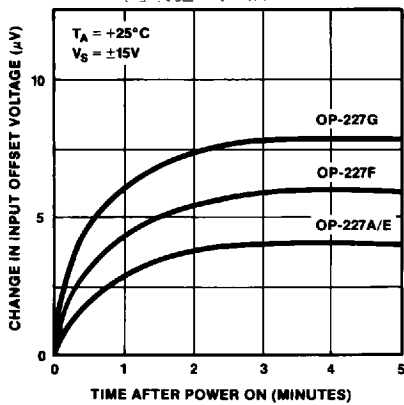

OFFSET VOLTAGE CHANGE DUE TO THERMAL SHOCK

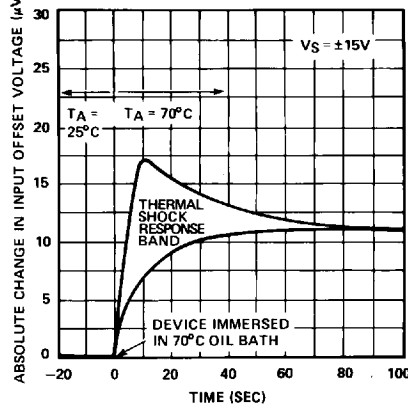

INPUT BIAS CURRENT vs TEMPERATURE

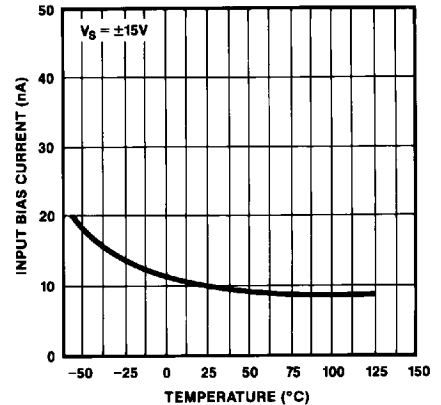

INPUT OFFSET CURRENT vs TEMPERATURE

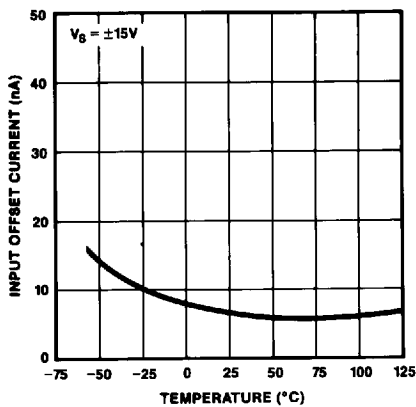

OPEN-LOOP GAIN vs FREQUENCY

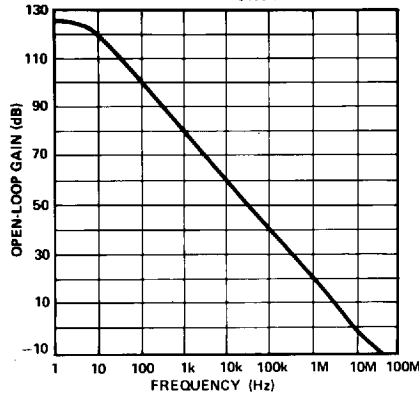

SLEW RATE, GAIN-BANDWIDTH PRODUCT, PHASE MARGIN vs TEMPERATURE

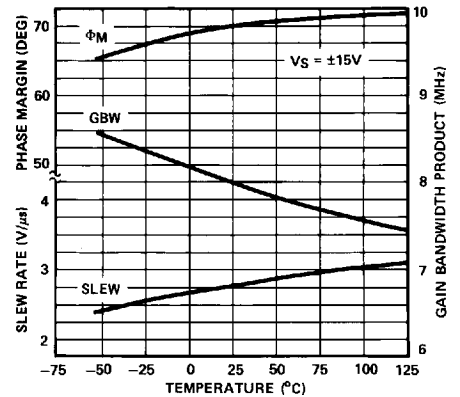

TYPICAL PERFORMANCE CHARACTERISTICS

GAIN, PHASE SHIFT vs FREQUENCY

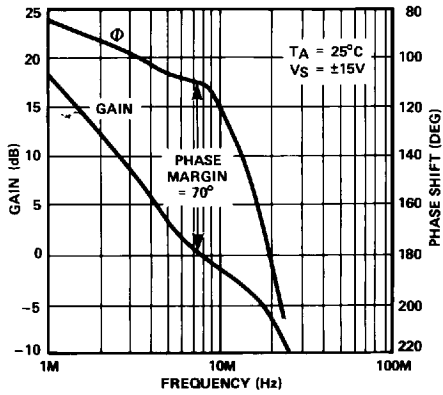

OPEN-LOOP GAIN vs SUPPLY VOLTAGE

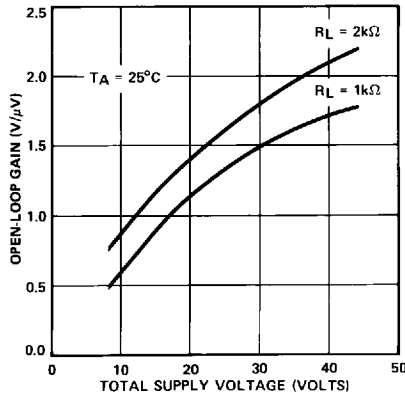

OUTPUT SWING vs RESISTIVE LOAD

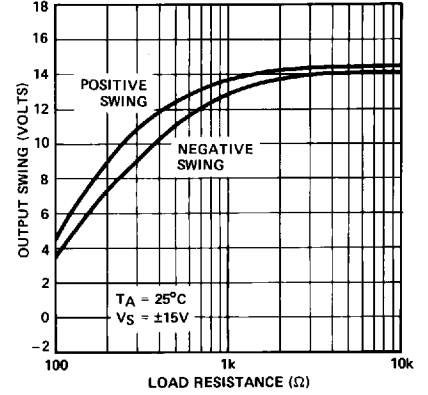

MAXIMUM UNDISTORTED OUTPUT vs FREQUENCY

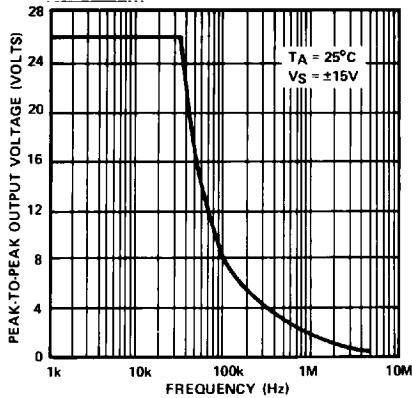

SMALL-SIGNAL OVERSHOOT vs CAPACITIVE LOAD

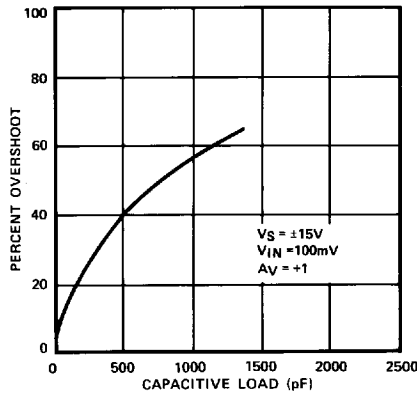

SHORT-CIRCUIT CURRENT vs TIME

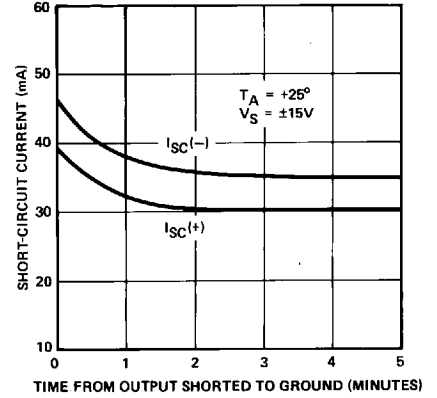

SMALL-SIGNAL TRANSIENT RESPONSE

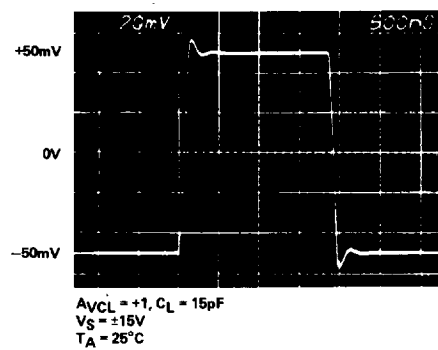

LARGE-SIGNAL TRANSIENT RESPONSE

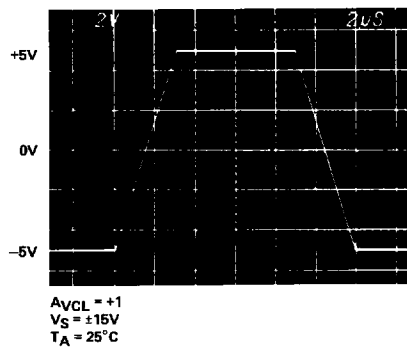

MATCHING CHARACTERISTIC CMRR MATCH vs FREQUENCY

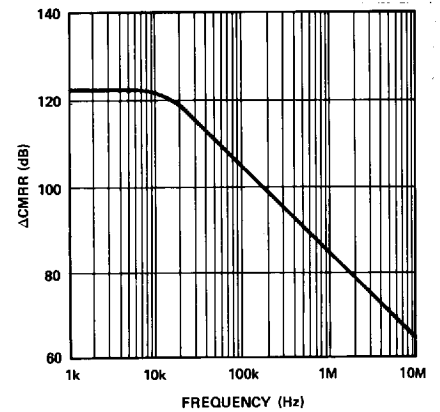

OP-227

TYPICAL PERFORMANCE CHARACTERISTICS

COMMON-MODE INPUT RANGE vs SUPPLY VOLTAGE

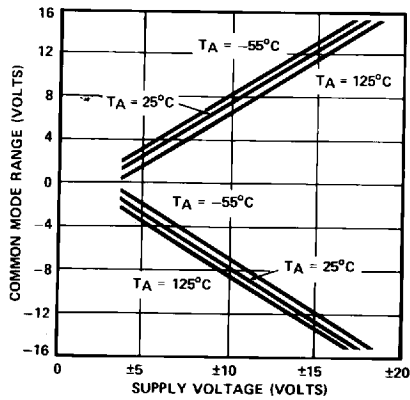

OPEN-LOOP VOLTAGE GAIN vs LOAD RESISTANCE

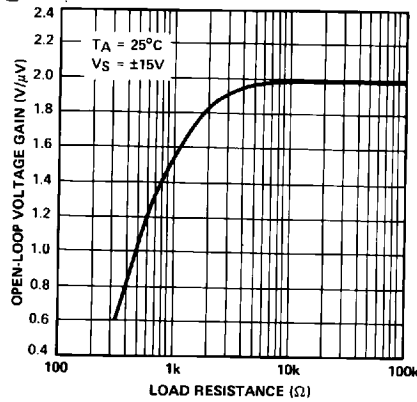

PSRR AND ΔPSRR vs FREQUENCY

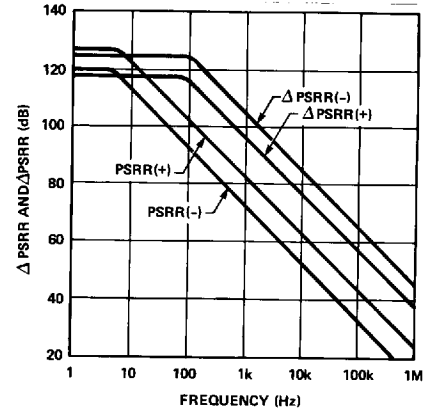

MATCHING CHARACTERISTIC; DRIFT OF OFFSET VOLTAGE MATCH OF REPRESENTATIVE UNITS

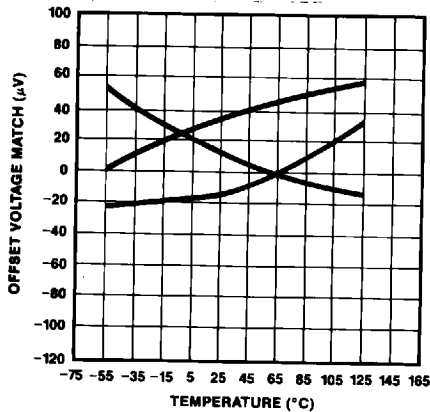

MATCHING CHARACTERISTIC; AVERAGE NONINVERTING BIAS CURRENT vs TEMPERATURE

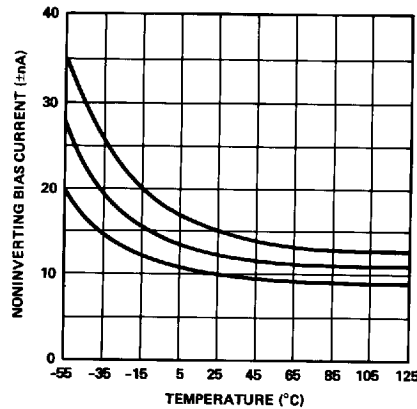

MATCHING CHARACTERISTIC; AVERAGE OFFSET CURRENT vs TEMPERATURE (INVERTING OR NONINVERTING)

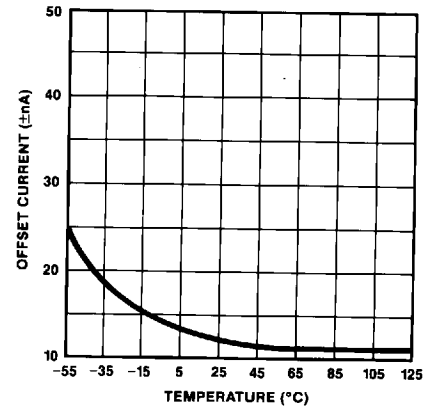

MATCHING CHARACTERISTIC; CMRR MATCH vs TEMPERATURE

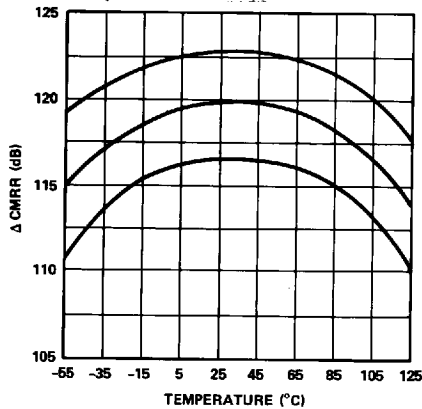

CHANNEL SEPARATION vs FREQUENCY

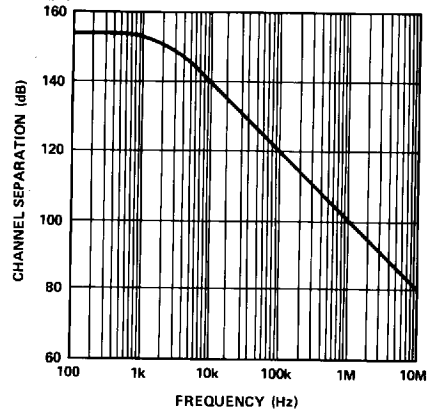

BASIC CONNECTIONS

OFFSET NULLING CIRCUIT

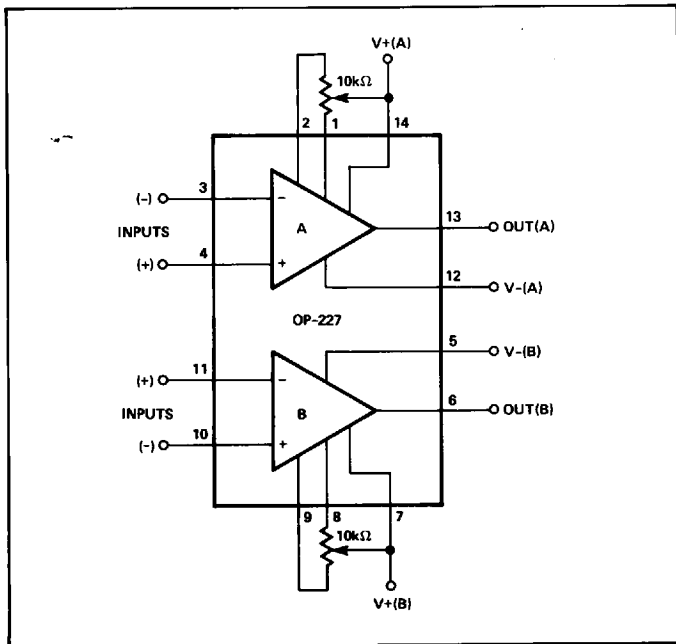

APPLICATIONS INFORMATION

NOISE MEASUREMENTS

To measure the 80nV peak-to-peak noise specification of the OP-227 in the 0.1Hz to 10Hz range, the following precautions must be observed:

- (1) The device has to be warmed-up for at least five minutes. As shown in the warm-up drift curve, the offset voltage typically changes 4μV due to increasing chip temperature after power-up. In the 10-second measurement interval these temperature-induced effects can exceed tens-of-nanovolts.
- (2) For similar reasons, the device has to be well-shielded from air currents. Shielding minimizes thermocouple effects.
- (3) Sudden motion in the vicinity of the device can also "feedthrough" to increase the observed noise.
- (4) The test time to measure 0.1Hz to 10Hz noise should not exceed 10 seconds. As shown in the noise-tester frequency-response curve, the 0.1Hz corner is defined by only one zero. The test time of 10 seconds acts as an additional zero to eliminate noise contributions from the frequency band below 0.1Hz.
- (5) A noise-voltage-density test is recommended when measuring noise on a large number of units. A 10Hz noise-voltage-density measurement will correlate well with a 0.1Hz-to-10Hz peak-to-peak noise reading, since both results are determined by the white noise and the location of the 1/f corner frequency.

INSTRUMENTATION AMPLIFIER APPLICATIONS OF THE OP-227

The excellent input characteristics of the OP-227 make it ideal for use in *instrumentation amplifier* configurations where low-level differential signals are to be amplified. The low-noise, low input offsets, low drift, and high gain combined with excellent CMR provides the characteristics needed for high-performance instrumentation amplifiers. In addition, CMR vs. frequency is very good due to the wide gain-bandwidth of these op amps.

The circuit of Figure 1 is recommended for applications where the common-mode input range is relatively low and differential gain will be in the range of 10 to 1000. This two-op-amp instrumentation amplifier features *independent* adjustment of common-mode rejection and differential gain. Input impedance is very high since both inputs are applied to non-inverting op amp inputs.

FIGURE 1: Two-Op-Amp Instrumentation Amplifier Configuration

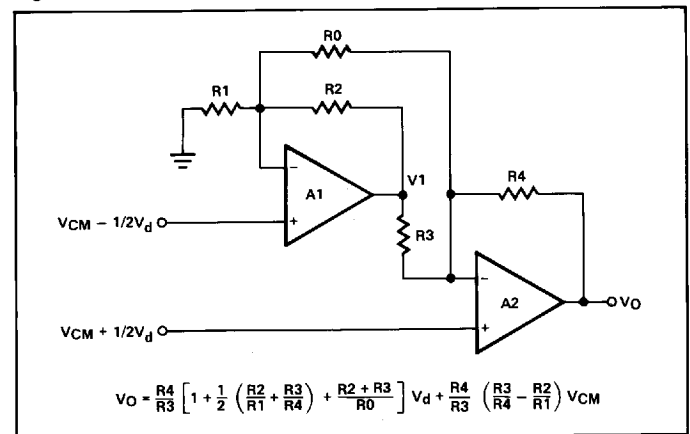

The output voltage V_O , assuming ideal op amps, is given in Fig. 1. The input voltages are represented as a common-mode input V_{CM} plus a differential input V_d . The ratio R_3/R_4 is made equal to the ratio R_2/R_1 to reject the common-mode input V_{CM} . The differential signal V_d is then amplified according to:

$$V_O = \frac{R_4}{R_3} \left(1 + \frac{R_3}{R_4} + \frac{R_2 + R_3}{R_0} \right) V_d, \text{ where } \frac{R_3}{R_4} = \frac{R_2}{R_1}$$

Note that gain can be independently varied by adjusting R_0 . From considerations of dynamic range, resistor tempco matching, and matching of amplifier response, it is generally best to make R_1 , R_2 , R_3 , and R_4 approximately equal. Designating R_1 , R_2 , R_3 , and R_4 as R_N allows the output equation to be further simplified:

$$V_O = 2 \left(1 + \frac{R_N}{R_0} \right) V_d, \text{ where } R_N = R_1 = R_2 = R_3 = R_4$$

Dynamic range is limited by A1 as well as A2; the output of A1 is:

$$V_1 = - \left(1 + \frac{R_N}{R_0} \right) V_d + 2 V_{CM}$$

OP-227

If the instrumentation amplifier were designed for a gain of 10 and maximum V_d of $\pm 1V$, then R_N/R_O would need to be four and V_O would be a maximum of $\pm 10V$. Amplifier A1 would have a maximum output of $\pm 5V$ plus $2V_{CM}$, thus a limit of $\pm 10V$ on the output of A1 would imply a limit of $\pm 2.5V$ on V_{CM} . A nominal value of $10k\Omega$ for R_N is suitable for most applications. A range of 20Ω to $2.5k\Omega$ for R_O will then provide a gain range of 10 to 1000. The current through R_O is V_d/R_O , so the amplifiers must supply $\pm 10mV/20\Omega$ (or $\pm 0.5mA$) when the gain is at the maximum value of 1000 and V_d is at $\pm 10mV$.

Rejecting common-mode inputs is important in accurately amplifying low-level differential signals. Two factors determine the CMR in this instrumentation amplifier configuration (assuming infinite gain):

- (1) CMR of the op amps
- (2) Matching of the resistor network ratios ($R_3/R_4 = R_2/R_1$)

In this instrumentation amplifier configuration, error due to CMR effect is directly proportional to the CMR match of the op amps. For the OP-227 this ΔCMR is a minimum of 97dB for the "G" and 110dB for the "E" grade. A ΔCMR value of 100dB and common-mode input range of $\pm 2.5V$ indicates a peak input-referred error of only $\pm 25\mu V$. Resistor matching is the other factor affecting CMR. Defining A_d as the differential gain of the instrumentation amplifier and assuming that R_1 , R_2 , R_3 and R_4 are approximately equal (R_N will be the nominal value), then CMR for this instrumentation amplifier configuration will be approximately A_d divided by $4\Delta R/R_N$. CMR at differential gain of 100 would be 88dB with resistor matching of 0.1%. Trimming R_1 to make the ratio R_3/R_4 equal to R_2/R_1 will raise the CMR until limited by linearity and resistor stability considerations.

The high open-loop gain of the OP-227 is very important to achieving high accuracy in the two op-amp instrumentation amplifier configuration. Gain error can be approximated by

$$\text{Gain Error} \sim \frac{1}{1 + \frac{A_d}{A_{O2}}} \cdot \frac{A_d}{2 A_{O1} A_{O2}} \ll 1$$

where A_d is the instrumentation amplifier differential gain and A_{O2} is the open-loop gain of op amp A2. This analysis assumes equal values of R_1 , R_2 , R_3 , and R_4 . For example, consider an OP-227 with A_{O2} of 700V/mV. If the differential gain A_d were set to 700, then the gain error would be 1/1.001 which is approximately 0.1%.

Another effect of finite op amp gain is undesired feedthrough of common-mode input. Defining A_{O1} as the open-loop gain of op amp A1, then the common-mode error (CME) at the output due to this effect will be approximately

$$\text{CME} \sim \frac{2 A_d}{1 + \frac{A_d}{A_{O1}}} \cdot \frac{1}{A_{O1}} V_{CM}$$

For $A_d/A_{O1} \ll 1$, this simplifies to $(2 A_d/A_{O1}) \times V_{CM}$. If the op amp gain is 700V/mV, V_{CM} is 2.5V, and A_d is set to 700, then the error at the output due to this effect will be approximately 5mV.

A complete instrumentation amplifier designed for a gain of 100 is shown in Figure 2. It has provision for trimming of input offset voltage, CMR, and gain. Performance is excellent due to the high gain, high CMR, and low noise of the individual amplifiers combined with the tight matching characteristics of the OP-227 dual.

FIGURE 2: Two-Op-Amp Instrumentation Amplifier Using OP-227 Dual

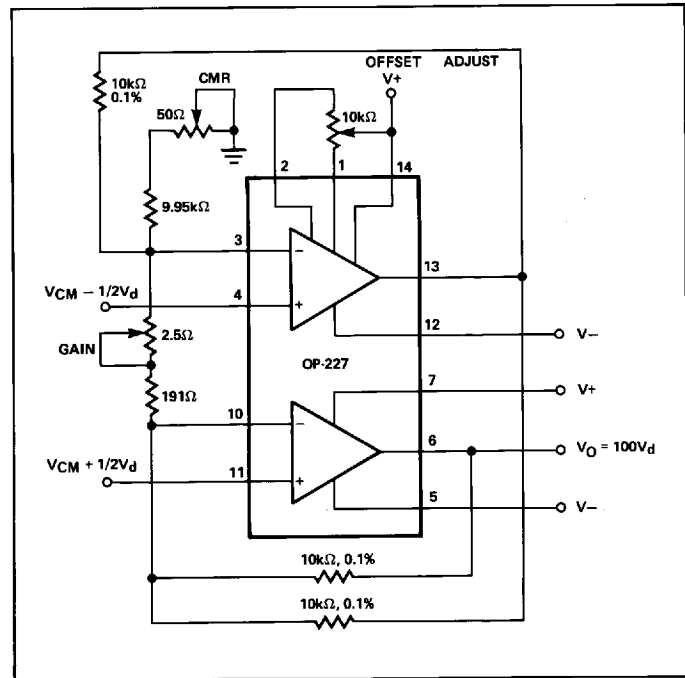

A three-op-amp instrumentation amplifier configuration using the OP-227 and OP-27 is recommended for applications requiring high accuracy over a wide gain range. This circuit provides excellent CMR over a wide frequency range. As with the two-op-amp instrumentation amplifier circuits, the tight matching of the two op-amps within the OP-227 package provides a real boost in performance. Also, the low-noise, low offset, and high gain of the individual op-amps minimize errors.

A simplified schematic is shown in Figure 3. The input stage (A1 and A2) serves to amplify the differential input V_d without amplifying the common-mode voltage V_{CM} . The output stage then rejects the common-mode input. With ideal op-amps and no resistor matching errors, then the outputs of each amplifier will be:

$$V_1 = -\left(1 + \frac{2R_1}{R_O}\right) \frac{V_d}{2} + V_{CM}$$

$$V_2 = \left(1 + \frac{2R_1}{R_O}\right) \frac{V_d}{2} + V_{CM}$$

$$V_O = V_2 - V_1 = \left(1 + \frac{2R_1}{R_O}\right) V_d$$

$$V_O = A_d V_d$$

The differential gain A_d is $1 + 2R_1/R_O$ and the common-mode input V_{CM} is rejected.

While output error due to input offsets and noise are easily determined, the effects of finite gain and common-mode rejection are more subtle. CMR of the complete instrumentation amplifier is directly proportioned to the *match* in CMR of the input op-amps. This match varies from 97dB to 110dB minimum for the OP-227. Using 100dB, then the output response to a common-mode input V_{CM} would be:

$$[V_O]_{CM} = A_d V_{CM} \times 10^{-5}$$

CMRR of the instrumentation amplifier, which is defined as $20 \log_{10} A_d/A_{CM}$, is simply equal to the Δ CMRR of the OP-227. While this Δ CMRR is already high, overall CMRR of the complete amplifier can be raised by trimming the output stage resistor network.

Finite gain of the input op-amps causes a scale factor error and a small degradation in CMR. Designating the open-loop gain of op-amp A_1 as A_{O1} , and op-amp A_2 as A_{O2} , then the following equation approximates the output:

$$V_O \sim \frac{1}{1 + \frac{R_1}{R_O} \left(\frac{1}{A_{O1}} + \frac{1}{A_{O2}} \right)} \left(A_d V_d + \frac{2R_1}{R_O} \left(\frac{1}{A_{O1}} - \frac{1}{A_{O2}} \right) V_{CM} \right)$$

This can be simplified by defining A_O as the nominal open-loop gain and ΔA_O as the differential open-loop gain. Then

$$V_O \sim \frac{1}{1 + \frac{2R_1}{R_O} \frac{1}{A_O}} \left(A_d V_d + \frac{2R_1}{R_O} \frac{\Delta A_O}{A_O^2} V_{CM} \right)$$

The high open-loop gain of each amplifier within the OP-227 (700,000 minimum at 25°C into $R_L \geq 2k$) assures good gain accuracy even at high values of A_d . The effect of finite open-loop gain on CMR can be approximated by:

$$CMRR \sim \frac{A_O^2}{\Delta A_O}$$

If $\Delta A_O/A_O$ were 6% and A_O were 600,000, then the CMRR due to finite gain of the input op-amps would be approximately 140dB.

FIGURE 3: Three-Op-Amp Instrumentation Amplifier Using OP-227 and OP-27

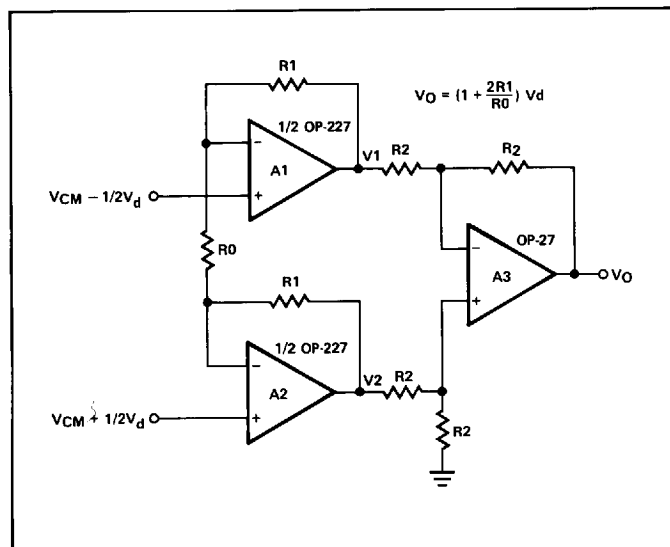

The unity-gain output stage contributes negligible error to the overall amplifier. However, matching of the four-resistor R_2 -network is critical to achieving high CMR. Consider a worst-case situation where each R_2 resistor has an error of $\pm \Delta R_2$. If the resistor ratio is high on one side and low on the other, then the common-mode gain will be $2\Delta R_2/R_2$. Since the output stage gain is unity, CMRR will then be $R_2/2\Delta R_2$. It is common practice to trim the R_2 resistor connected to ground to maximize overall CMRR for the total instrumentation amplifier circuit.

This three-op-amp instrumentation amplifier configuration provides excellent performance over a wide gain range. A gain range of 1 to 2000 is practical and CMR of over 120dB is achievable.

OP-227

HIGH SPEED PRECISION RECTIFIER

The low offsets and excellent load driving capability of the OP-27 are key advantages in this precision rectifier circuit. The summing impedances can be as low as $1\text{k}\Omega$ which helps to reduce the effects of stray capacitance.

For positive inputs, D2 conducts and D1 is biased OFF. Amplifiers A1 and A2 act as a follower with output-to-input feedback and the R1 resistors are no critical. For negative inputs, D1 conducts and D2 is biased OFF. A1 acts as a follower and A2 serves as a precision inverter. In this mode, matching of the two R1 resistors is critical to gain accuracy.

Typical component values are 30pF for C1 and $2\text{k}\Omega$ for R3. The drop across D1 must be less than the drop across the FET diode D2. A 1N914 for D1 and a 2N4393 for the JFET were used successfully.

The circuit provides full-wave rectification for inputs of up to $\pm 10\text{V}$ and up to 20kHz in frequency. To assure frequency stability, be sure to decouple the power supply inputs and minimize any capacitive loading. An OP-227, which is two OP-27 amplifiers in a single package, can be used to improve packaging density.

FIGURE 4: High Speed Precision Rectifier

