



Holy Stone Enterprise Co., Ltd

OT-STM315/434AB

DESCRIPTION

STM is a low cost A.S.K. SAW transmitter module. It makes RF remote techniques easily, just input the data code and output with a high stability RF signal.

FEATURES

- SAW chip on board technology
- Low power consumption
- Operation temperature range : - 20°C ~ +70°C
- Wide range of operation voltage : 1.5~15 Volts.
- Easy for application
- RF output -10~+16dBm at 3V DC operation voltage
- Available frequency at follows :
433.92 / 315 MHz

APPLICATIONS

- Car security system
- Garage door controller
- Home security
- Wireless mouse
- Automation system

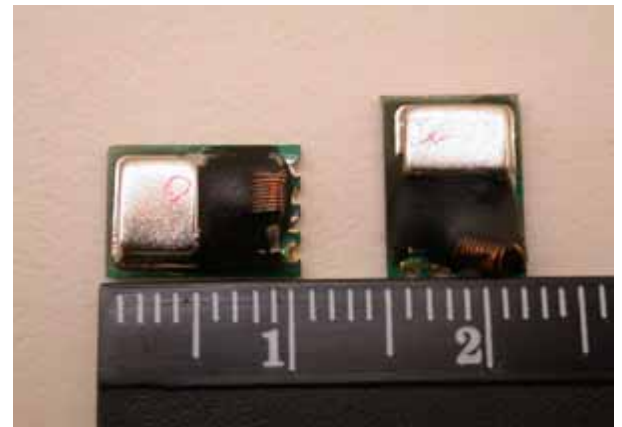

PIN ASSIGNMENT

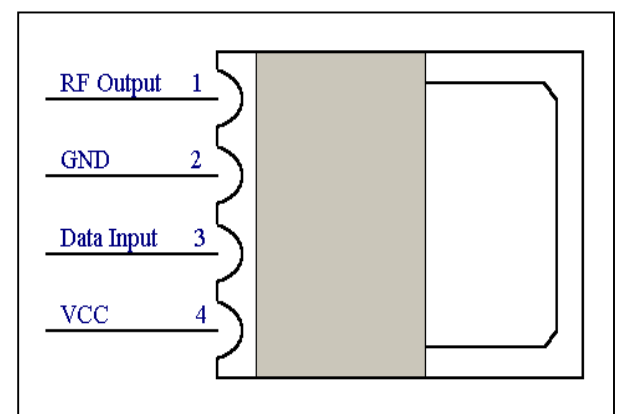

BLOCK DIAGRAM

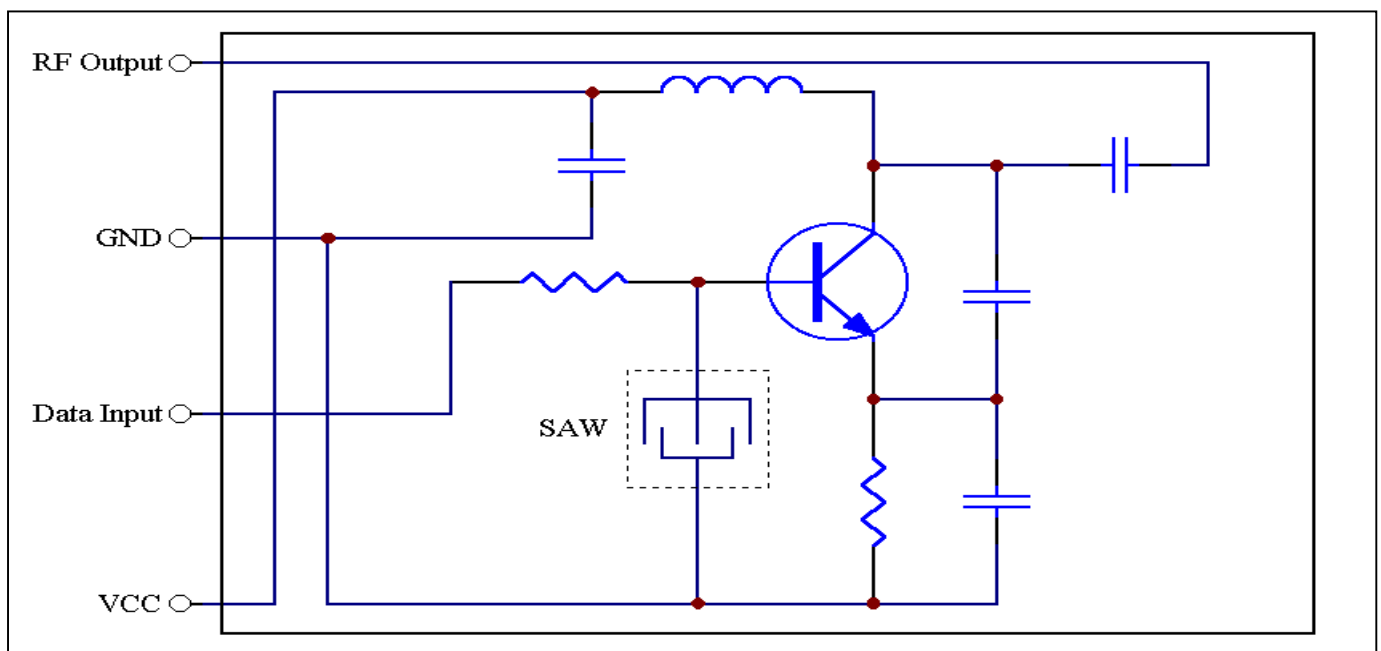

Absolute Maximum Ratings

Parameter	Rating	Units
Supply Voltage	- 0.3 to 15	V DC
Data Input Voltage	- 0.3 to VDD+0.3	V DC
Operating Temperature	- 20 to 70	°C
Storage Temperature	- 40 to 150	°C

Parameter	Specification			Unit	Condition
	Min.	Typical	Max.		
Frequency Range Fix by SAW		315 433.92		MHz	
Frequency Accuracy A		±75		kHz	
Frequency Accuracy B		±250		kHz	
Frequency Accuracy AB		±150		kHz	
Output Power	0	1	3	dBm	At 3 Volt. Power 50Ω Load
	3	5	8	dBm	At 12Volt. Power 50Ω Load
Current	3	4	5	mA	At 3 Volt. Power Data Input = VDD
Consumption	17	20	25	mA	At 12Volt. Power Data Input = VDD
Modulation Frequency	0	1	2	kHz	On-Off Key (OOK)

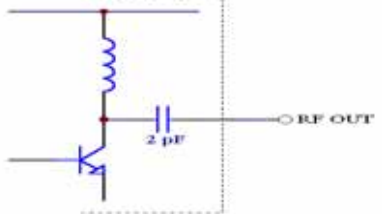
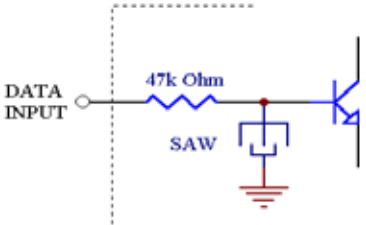
PIN NO.	Function	Description	Inter Connection
1	RF Output	OSC Unbuffered Output	
2	GND	Ground Connection	
3	Data Input	On-Off Key Logic Data Input	

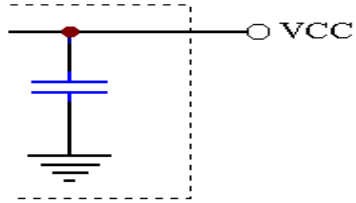
4	VCC	DC Positive Power Supply	
---	-----	--------------------------	--

PACKAGE DIMENSION

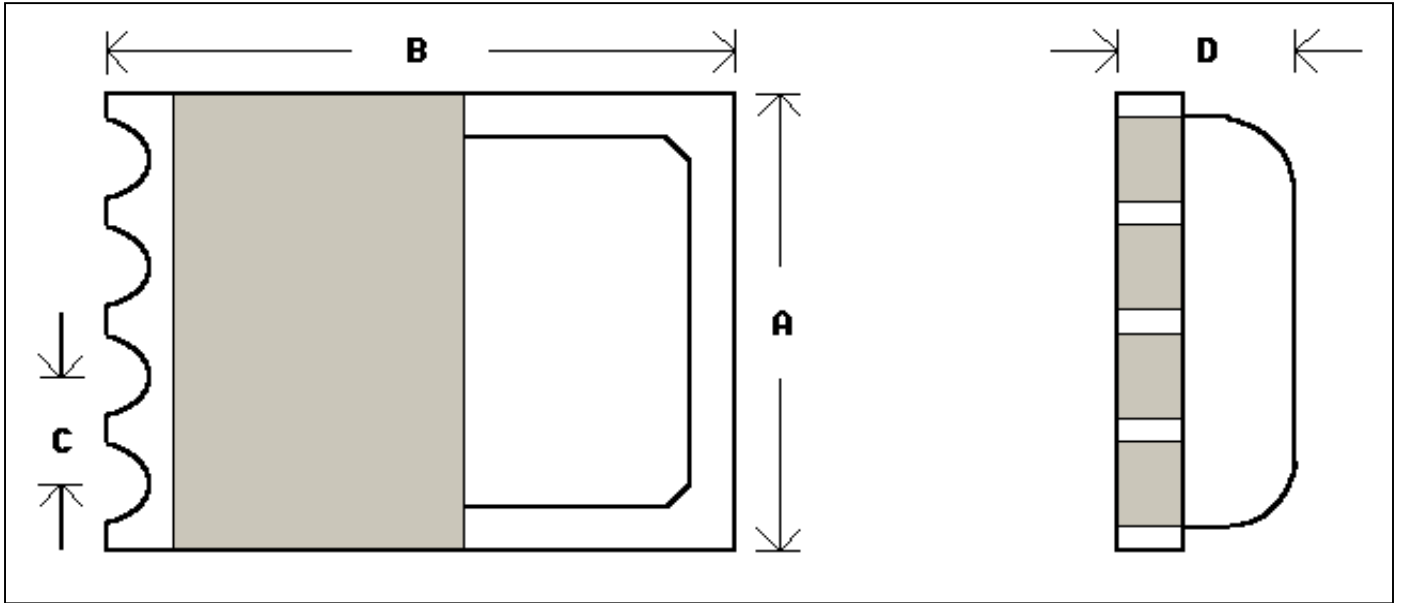

FREQUENCY	STM SIZE	DIMENSIONS (UNIT : mm)			
		A	B	C	D
303~315 MHz	L	7.60	11.0	1.70	3.0
340~434 MHz	S	6.80	10.0	1.70	3.0