

# High-Intensity Red LED in Plastic T-1<sup>3</sup>/<sub>4</sub> Package

## OVLGS0Cx9

- Narrow Beam Angle
- High Luminous Intensity
- Water Clear Plastic Package
- Red (631nm)

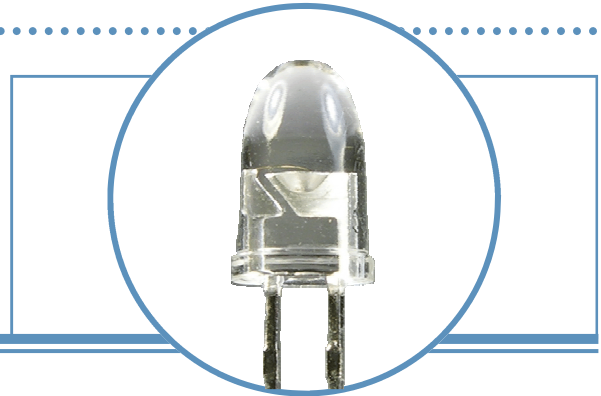

The OVLGS0Cx9 is a high intensity AlInGaP LED mounted in a clear plastic T-1<sup>3</sup>/<sub>4</sub> package. The device incorporates an integral molded lens that enables a narrow beam angle and provides an even emission pattern. Designed to produce light over a wide range of drive currents, this LED is useful in applications requiring higher on-axis brightness than that achievable with standard lamps.

### Applications

- Indoor/Outdoor Applications
- Message Boards
- Store Front Signage
- Indicators

Part Number	Material	Emitted Color	Intensity Typ. mcd	Lens Color
OVLGS0C6B9	AlInGaP	Red	6300	Water Clear
OVLGS0C7B9			8000	
OVLGS0C8B9			10000	

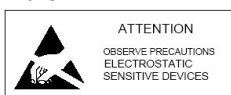
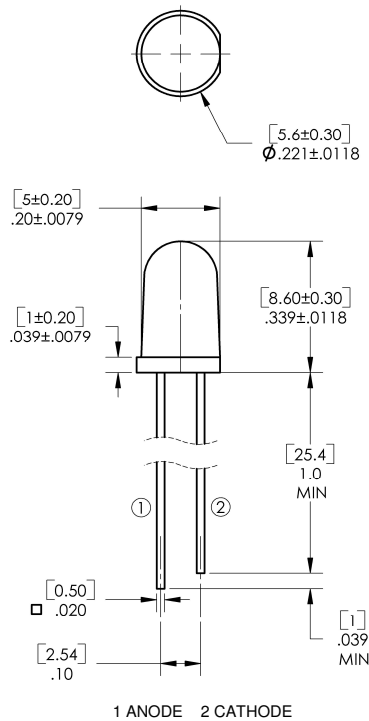

OPTEK reserves the right to make changes at any time in order to improve design and to supply the best product possible.

# T-1 $\frac{3}{4}$ High-Intensity Red LED

## OVLGS0CxB9



### Absolute Maximum Ratings

$T_A = 25^\circ\text{C}$  unless otherwise noted

Storage Temperature Range	-40 ~ +100 °C
Operating Temperature Range	-40 ~ +85 °C
Reverse Voltage	5 V
Continuous Forward Current <sup>2</sup>	50 mA
Peak Forward Current (10% Duty Cycle, 1KHz)	100 mA
Power Dissipation	120 mW
Lead Soldering Temperature (3mm from the base of the epoxy bulb) <sup>1</sup>	260 °C
Electrostatic Discharge	2000 V

Note:

1. Solder time less than 5 seconds at temperature extreme.

### Electrical Characteristics

$T_A = 25^\circ\text{C}$  unless otherwise noted

SYMBOL	PARAMETER	MIN	TYP	MAX	UNITS	CONDITIONS	
$I_v$	Luminous Intensity	x = 6	4000	6300	----	mcd	$I_F = 20\text{mA}$
		7	5000	8000	----		
		8	6300	10000	----		
$V_F$	Forward Voltage	----	2.0	2.4	V	$I_F = 20\text{mA}$	
$I_R$	Reverse Current	----	----	10	$\mu\text{A}$	$V_R = 5\text{V}$	
$\lambda_P$	Peak Wavelength	----	624	----	nm	$I_F = 20\text{mA}$	
$\lambda_D$	Dominant Wavelength	----	631	----	nm	$I_F = 20\text{mA}$	
$2\Theta_{\frac{1}{2}\text{H-H}}$	50% Power Angle	----	6	----	deg	$I_F = 20\text{mA}$	

Typical Electro-Optical Characteristics Curves

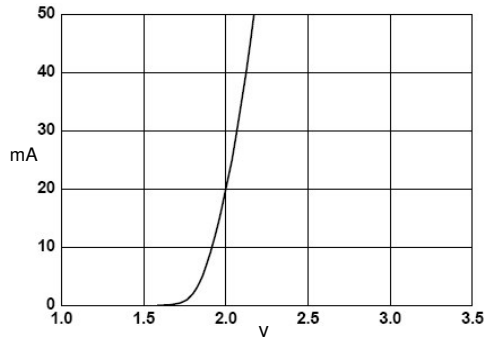

Forward Current vs. Forward Voltage

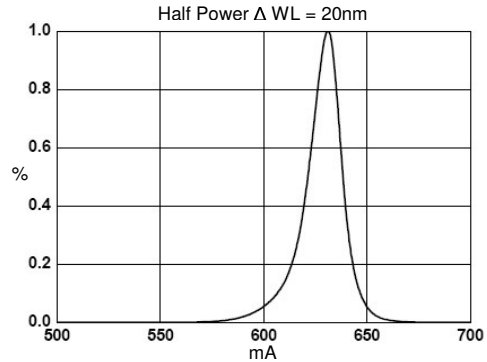

Relative Luminous Intensity vs. Wavelength

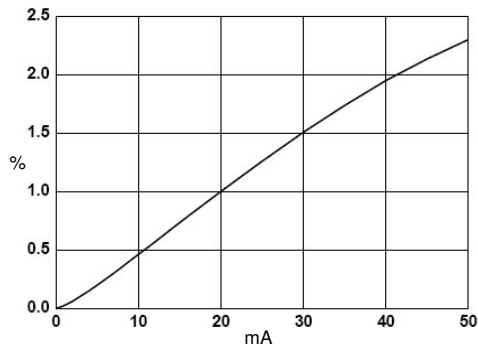

Relative Luminous Intensity vs. Forward Current

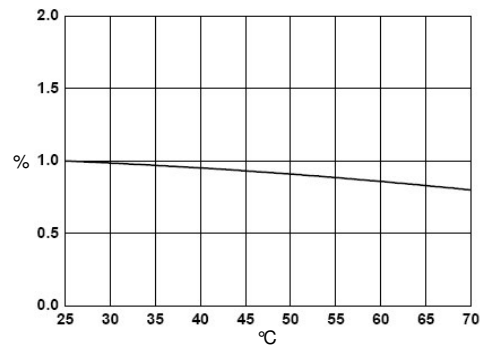

Relative Luminous Intensity vs. Ambient Temperature

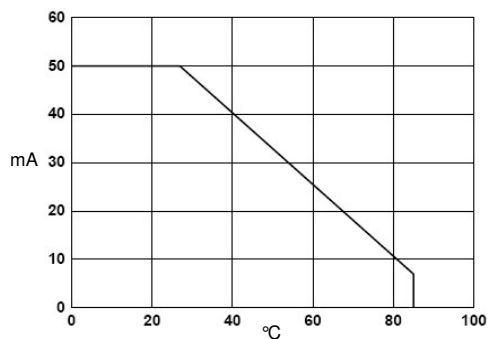

Forward Current vs. Ambient Temperature

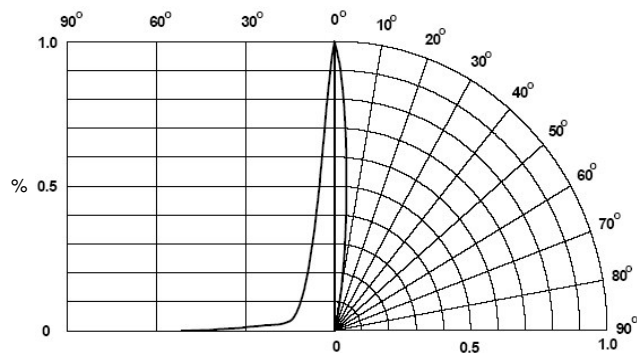

Relative Intensity vs. Radiation Angle

T-1¾ High-Intensity Red LED  
OVLGS0CxB9



Issue	Change Description	Approval	Date
1.0	Initial Release	J. Haynie	6/7/05