

# High-Intensity Yellow LED in Plastic T-1<sup>3</sup>/<sub>4</sub> Package

## OVLGY0Cx9

- Narrow Beam Angle
- High Luminous Intensity
- Water Clear Plastic Package
- Yellow (589nm)

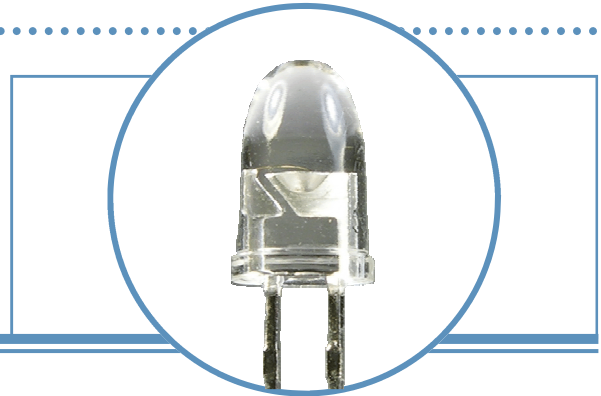

The OVLGY0Cx9 is a high intensity AlInGaP LED mounted in a clear plastic T-1<sup>3</sup>/<sub>4</sub> package. The device incorporates an integral molded lens that enables a narrow beam angle and provides an even emission pattern. Designed to produce light over a wide range of drive currents, this LED is useful in applications requiring higher on-axis brightness than that achievable with standard lamps.

### Applications

- Indoor/Outdoor Applications
- Message Boards
- Store Front Signage
- Indicators

Part Number	Material	Emitted Color	Intensity Typ. mcd	Lens Color
OVLGY0C6B9	AlInGaP	Yellow	10000	Water Clear
OVLGY0C7B9			12500	
OVLGY0C8B9			16000	
OVLGY0C9B9			20000	

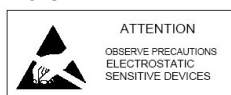
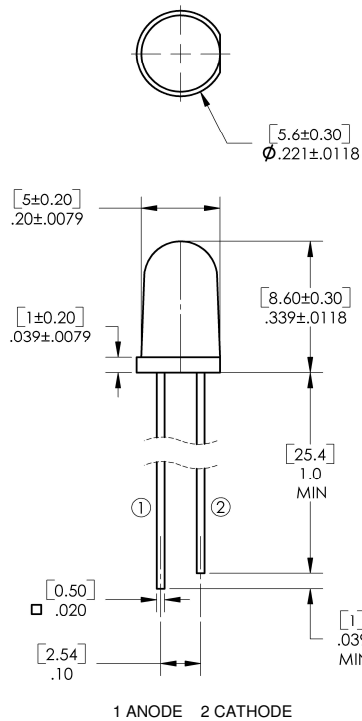

OPTEK reserves the right to make changes at any time in order to improve design and to supply the best product possible.

# T-1 $\frac{3}{4}$ High-Intensity Yellow LED

## OVLGY0CxB9



### Absolute Maximum Ratings

T<sub>A</sub> = 25°C unless otherwise noted

Storage Temperature Range	-40 ~ +100 °C
Operating Temperature Range	-40 ~ +85 °C
Reverse Voltage	5 V
Continuous Forward Current <sup>2</sup>	50 mA
Peak Forward Current (10% Duty Cycle, 1KHz)	100 mA
Power Dissipation	120 mW
Lead Soldering Temperature (3mm from the base of the epoxy bulb) <sup>1</sup>	260 °C
Electrostatic Discharge	2000 V

Note:

- Solder time less than 5 seconds at temperature extreme.

### Electrical Characteristics

T<sub>A</sub> = 25°C unless otherwise noted

SYMBOL	PARAMETER	MIN	TYP	MAX	UNITS	CONDITIONS	
I <sub>v</sub>	Luminous Intensity	x = 6	6300	10000	----	mcd	I <sub>F</sub> = 20mA
		7	8000	12500	----		
		8	10000	16000	----		
		9	12500	20000	----		
V <sub>F</sub>	Forward Voltage	----	2.0	2.4	V	I <sub>F</sub> = 20mA	
I <sub>R</sub>	Reverse Current	----	----	10	μA	V <sub>R</sub> = 5V	
λ <sub>P</sub>	Peak Wavelength	----	591	----	nm	I <sub>F</sub> = 20mA	
λ <sub>D</sub>	Dominant Wavelength	----	589	----	nm	I <sub>F</sub> = 20mA	
2Θ $\frac{1}{2}$ H-H	50% Power Angle	----	6	----	deg	I <sub>F</sub> = 20mA	

Typical Electro-Optical Characteristics Curves

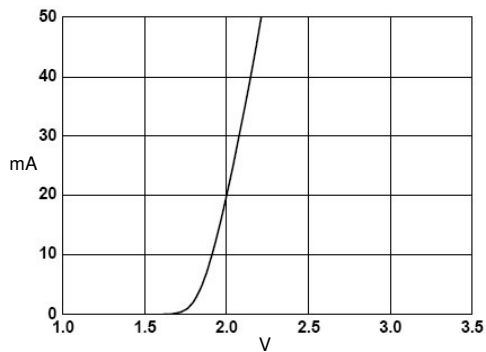

Forward Current vs. Forward Voltage

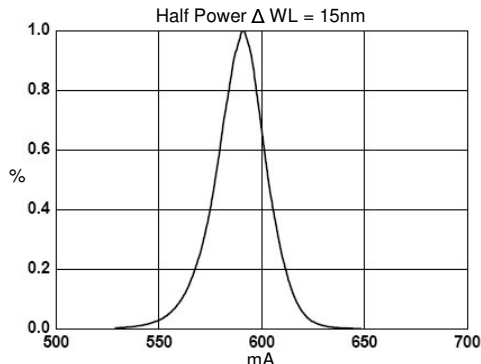

Relative Luminous Intensity vs. Wavelength

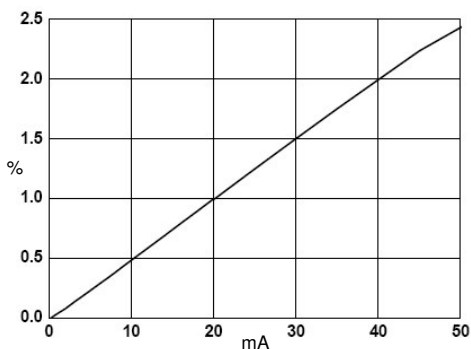

Relative Luminous Intensity vs. Forward Current

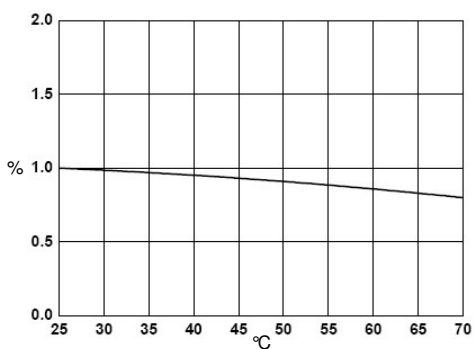

Relative Luminous Intensity vs. Ambient Temperature

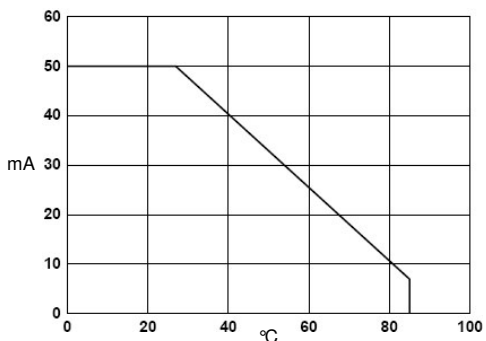

Forward Current vs. Ambient Temperature

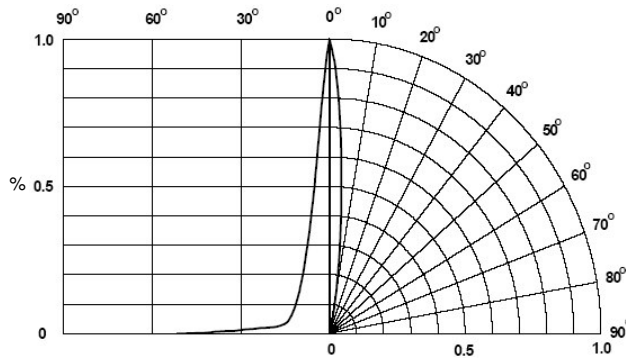

Relative Intensity vs. Radiation Angle



Issue	Change Description	Approval	Date
1.0	Initial Release	J. Haynie	6/7/05