

0.25-6.0 GHz High Dynamic Range Amplifier

Features

- ✕ 0.25 to 6.0 GHz Frequency Range
- ✕ +41 dBm Output IP3
- ✕ 1.7 dB Noise Figure
- ✕ 15 dB Gain
- ✕ +23 dBm P1dB
- ✕ LGA Package
- ✕ Single Power Supply
- ✕ Single Input Matching

Description

The CMM6004-AH is a high dynamic range amplifier designed for applications operating within the 0.25 to 6.0 GHz frequency range. It is an ideal solution for numerous transmit and receive functions in wireless local loop (WLL) and UNH applications where high linearity is required.

The amplifier has the flexibility of being optimized for a number of wireless applications. It is an ideal solution when used as a driver amplifier in applications including cellular and PCS (personal communications services) operating from 0.8 to 2.2 GHz; MMDS (multichannel multipoint distribution systems) operating from 2.2 to 2.7 GHz; WLAN (wireless LAN) operating at 2.4 GHz; WLL (wireless local loop) operating at 3.5 GHz; and HiperLAN (high performance LAN) and U-NII (unlicensed national information infrastructure) operating from 5.0 to 6.0 GHz.

The CMM6004-AH is packaged in a low-cost, space efficient, Land Grid Array (LGA) package which provides excellent electrical stability and low thermal resistance. All devices are 100% RF and DC tested. With single input matching the part simplifies design by keeping board space and cost to a minimum.

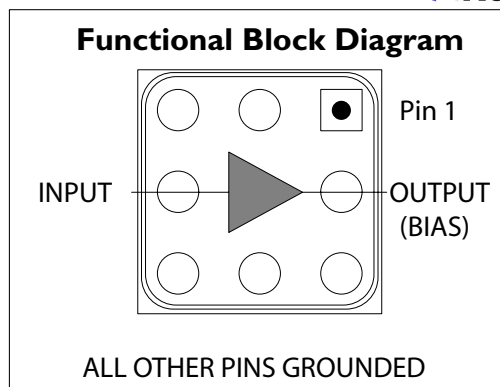

Absolute Maximum Ratings

Supply Voltage	+6.0 V
RF Input Power*	+20 dBm
Storage Temperature	-55°C to 125°C
Junction Temperature	150°C
Operating Temperature	-40°C to +85°C
Thermal Resistance	50°C/W

Operation of this device above any of these parameters may cause permanent damage.

*Operation with more than 10 dBm of RF input power may cause 2 dB degradation in OIP3 performance.

Applications

- ✕ Wireless Local Loop Transmit and Receive
- ✕ UNH Transmit and Receive
- ✕ Dual Band 802.11 WLAN
- ✕ WiMAX
- ✕ LAN

Electrical Characteristics (T=25°C)

Unless otherwise specified, the following specifications are guaranteed at room temperature in a Mimix test fixture.

Parameter	Condition	Min	Typ	Max	Units
Frequency Range		0.25		6.0	GHz
Gain	Externally matched	13.5	15		dB
Input Return Loss	Externally matched		-10		dB
Output IP3		38	41		dBm
Noise Figure			1.7		dB
Output P1dB			23.0		dBm
Operating Current Range		120	150	180	mA
Supply Voltage			5.0		V

Notes:

1. T = 25°C, Vdd = 5V, Frequency = 2 GHz, 50 Ohm system.

2. OIP3 measured with two tones at output power of 5 dBm/tone separated by 10 MHz.

0.25-6.0 GHz High Dynamic Range Amplifier

Application Circuit (836 MHz)

Typical Performance (50 Ohm System)

Frequency	836 MHz
Gain	18 dB
Input Return Loss	-23 dB
Output Return Loss	-14 dB
OIP3	40 dBm
Noise Figure	1.75 dB
Bias	V _{ds} = 5V, I _d = 175 mA

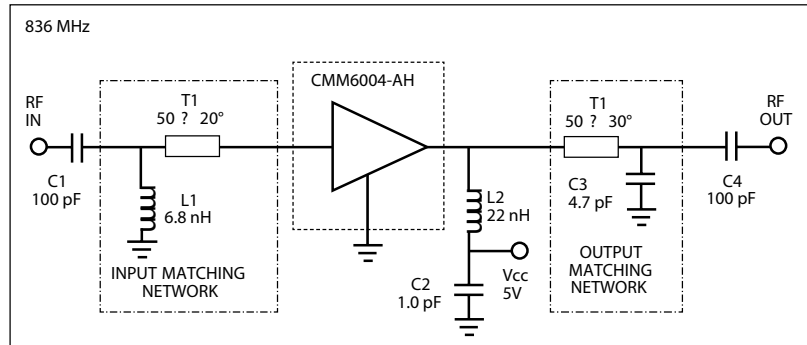

Circuit Board Parts List

Part Type	Reference Designator	Description
Inductor	L1	0603, 6.8 nH
Inductor	L2	0603, 22 nH
Capacitor	C1, C4	SMD 0805 NPO, 100 pF
Capacitor	C2	0603, 1 pF
Capacitor	C3	SMD 0805, 50V ±0.25 pF 4.7 pF

Typical Performance

IP3 measured with 2 tones at an output power of 5 dBm/tone separated by 10 MHz

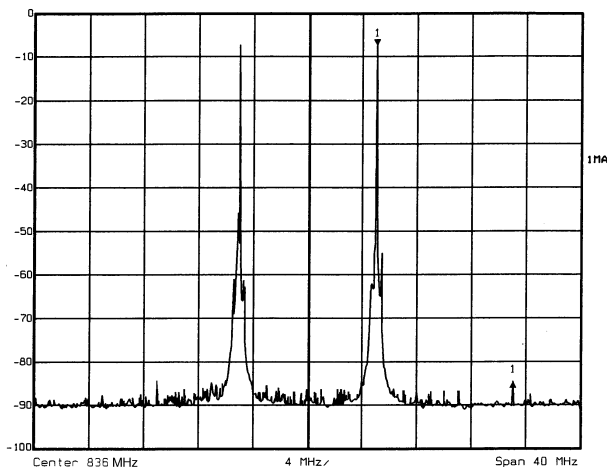

Gain, Input Return Loss and Output Return Loss vs Frequency

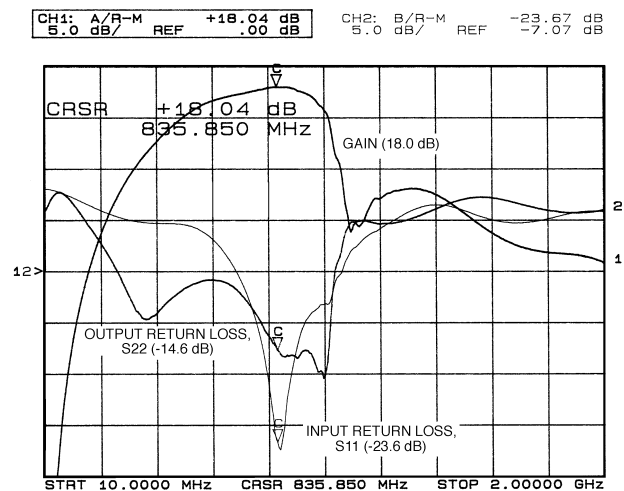

0.25-6.0 GHz High Dynamic Range Amplifier

Application Circuit (2.1 GHz)

Typical Performance (50 Ohm System)

Frequency	2.1 GHz
Gain	15.8 dB
Input Return Loss	-14 dB
Output Return Loss	-16.5 dB
OIP3	40 dBm
Noise Figure	2.95 dB
Bias	V _{ds} = 5V, I _d = 175 mA

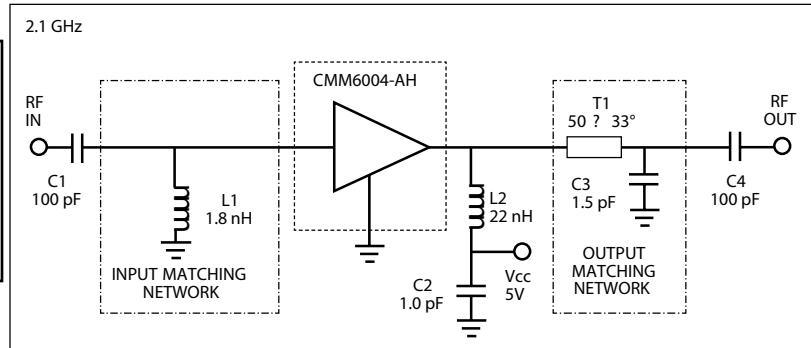

Circuit Board Parts List

Part Type	Reference Designator	Description
Inductor	L1	0603, ±0.3, 1.8 nH
Inductor	L2	0603, 22 nH
Capacitor	C1, C4	SMD 0805 NPO, 100 pF
Capacitor	C2	0603, 1 pF
Capacitor	C3	SMD 0603, 50V ±0.1 pF 1.5 pF

Typical Performance

IP3 measured with 2 tones at an output power of 5 dBm/tone separated by 10 MHz

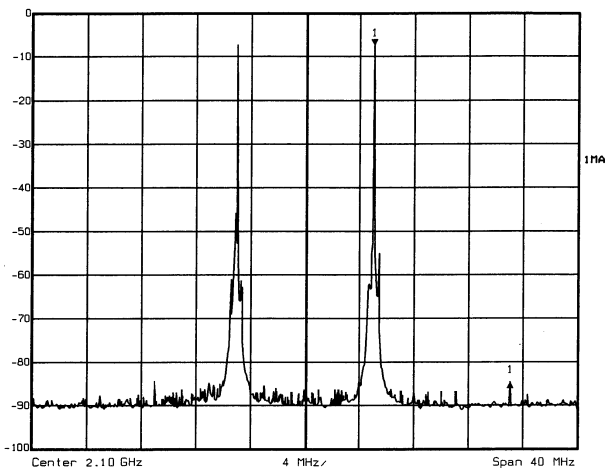

Gain, Input Return Loss and Output Return Loss vs Frequency

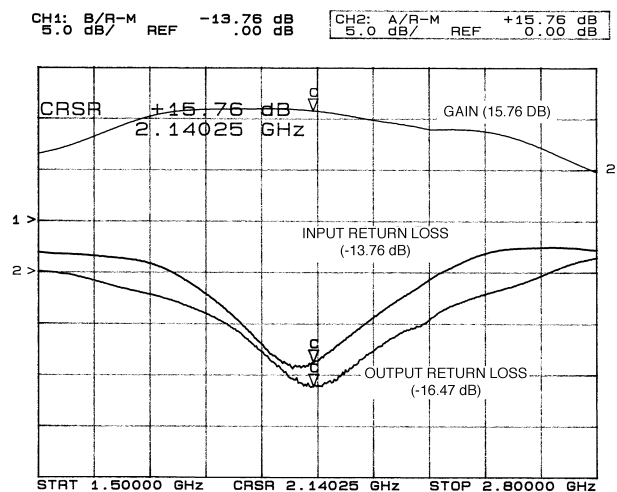

0.25-6.0 GHz High Dynamic Range Amplifier

February 2007 - Rev 10-Feb-07

CMM6004-AH
RoHS

Application Circuit (5.8 GHz)

Typical Performance (50 Ohm System)

Frequency	5.8 GHz
Gain	10.5 dB
Input Return Loss	-11.5 dB
Output Return Loss	-17.2 dB
OIP3	40 dBm
Noise Figure	3.8 dB
Bias	V _{ds} = 5V, I _d = 175 mA

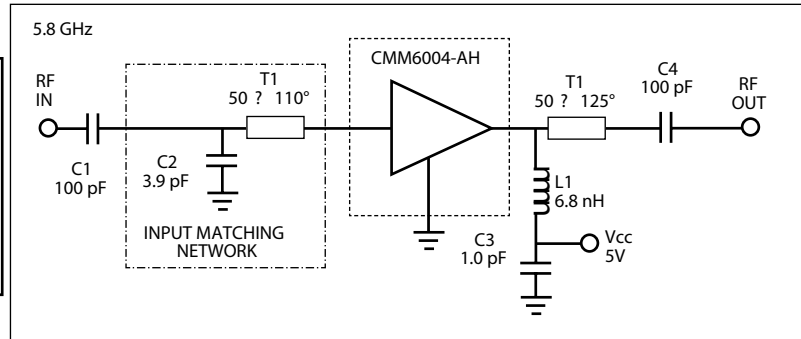

Circuit Board Parts List

Part Type	Reference Designator	Description
Inductor	L1	0603, 6.8 nH
Capacitor	C1, C4	SMD 0805 NPO, 100 pF
Capacitor	C2	SMD 0805, 3.9 pF
Capacitor	C3	0603, 1 pF

Typical Performance

Gain vs Temperature @ 5.8 GHz

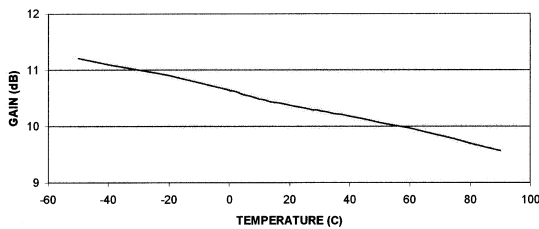

IP3 vs Temperature @ 5.8 GHz

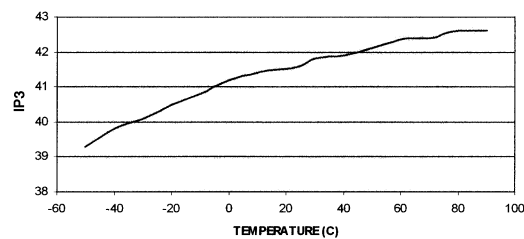

IP3 measured with 2 tones at an output power of 5 dBm/tone separated by 10 MHz

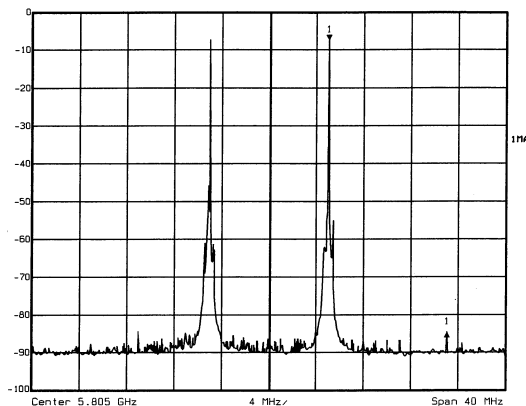

Gain, Input Return Loss and Output Return Loss vs Frequency

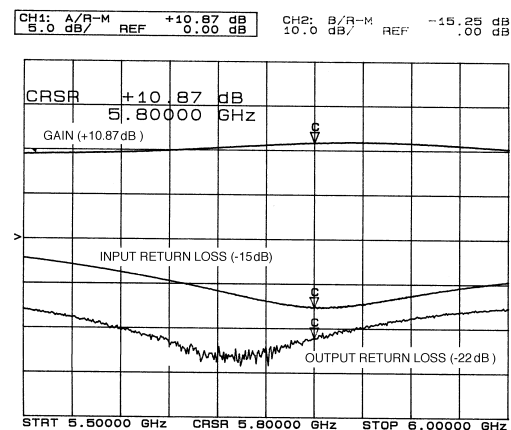

0.25-6.0 GHz High Dynamic Range Amplifier



February 2007 - Rev 10-Feb-07

CMM6004-AH
RoHS

Physical Dimensions

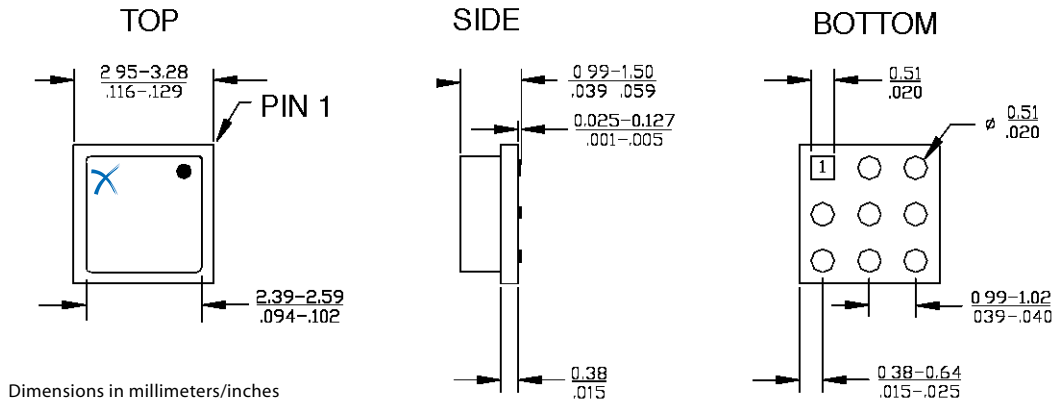

Mounting Recommendation

*Board substrate:
RO-4003
Thickness = 31 mil

*Ground vias are critical to RF and thermal grounding considerations.

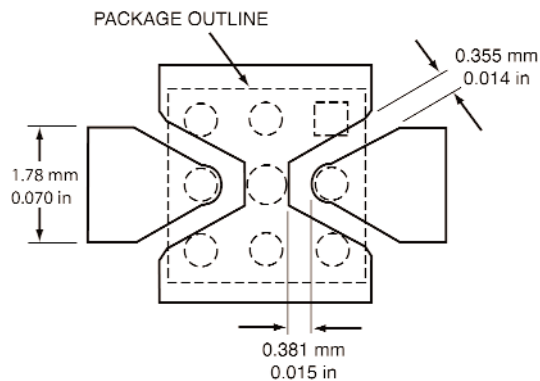

0.25-6.0 GHz High Dynamic Range Amplifier

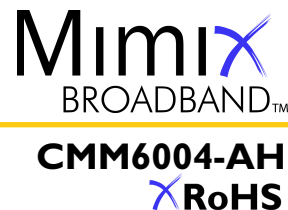

February 2007 - Rev 10-Feb-07

Handling and Assembly Information

CAUTION! - Mimix Broadband MMIC Products contain gallium arsenide (GaAs) which can be hazardous to the human body and the environment. For safety, observe the following procedures:

- Do not ingest.
- Do not alter the form of this product into a gas, powder, or liquid through burning, crushing, or chemical processing as these by-products are dangerous to the human body if inhaled, ingested, or swallowed.
- Observe government laws and company regulations when discarding this product. This product must be discarded in accordance with methods specified by applicable hazardous waste procedures.

Life Support Policy - Mimix Broadband's products are not authorized for use as critical components in life support devices or systems without the express written approval of the President and General Counsel of Mimix Broadband. As used herein: (1) Life support devices or systems are devices or systems which, (a) are intended for surgical implant into the body, or (b) support or sustain life, and whose failure to perform when properly used in accordance with instructions for use provided in the labeling, can be reasonably expected to result in a significant injury to the user. (2) A critical component is any component of a life support device or system whose failure to perform can be reasonably expected to cause the failure of the life support device or system, or to affect its safety or effectiveness.

Package Attachment - This packaged product from Mimix Broadband is provided as a rugged surface mount package compatible with high volume solder installation. Care should be taken not to apply heavy pressure to the top or base material to avoid package damage. Vacuum tools or other suitable pick and place equipment may be used to pick and place this part. Care should be taken to ensure that there are no voids or gaps in the solder connection so that good RF, DC and ground connections are maintained. Voids or gaps can eventually lead not only to RF performance degradation, but reduced reliability and life of the product due to thermal stress.

Mimix Lead-Free RoHS Compliant Program - Mimix has an active program in place to meet customer and governmental requirements for eliminating lead (Pb) and other environmentally hazardous materials from our products. All Mimix RoHS compliant components are form, fit and functional replacements for their non-RoHS equivalents. Lead plating of our RoHS compliant parts is 100% matt tin (Sn) over copper alloy and is backwards compatible with current standard SnPb low-temperature reflow processes as well as higher temperature (260°C reflow) "Pb Free" processes.

Ordering Information

Part Number for Ordering	Package
CMM6004-AH-0000	RoHS compliant LGA surface-mount power package in bulk quantity
CMM6004-AH-000T	RoHS compliant LGA surface-mount power package in tape and reel
PB-CMM6004-AH-00A0	Evaluation Board with SMA connectors for 900 MHz
PB-CMM6004-AH-00B0	Evaluation Board with SMA connectors for 1.9 GHz
PB-CMM6004-AH-00C0	Evaluation Board with SMA connectors for 5.8 GHz

We also offer this product with SnPb (Tin-Lead) or NiPdAu plating. Please contact your regional sales manager for more information regarding different plating types.