



PD54003L

RF POWER TRANSISTORS The *LdmoST* PLASTIC FAMILY

ADVANCED DATA

N-CHANNEL ENHANCEMENT-MODE LATERAL MOSFETs

- EXCELLENT THERMAL STABILITY
- COMMON SOURCE CONFIGURATION
- $P_{OUT} = 3\text{ W}$ WITH 20 dB gain @ 500 MHz
- NEW LEADLESS PLASTIC PACKAGE
- ESD PROTECTION
- SUPPLIED IN TAPE & REEL OF 3K UNITS

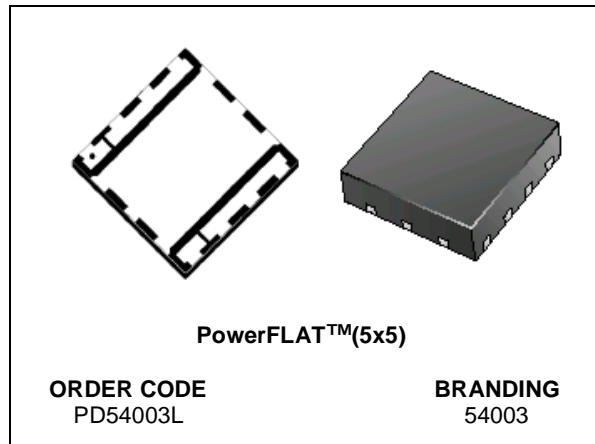

DESCRIPTION

The PD54003L is a common source N-Channel, enhancement-mode lateral Field-Effect RF power transistor. It is designed for high gain, broad band commercial and industrial applications. It operates at 7 V in common source mode at frequencies of up to 1 GHz. PD54003L boasts the excellent gain, linearity and reliability of STH1LV latest LDMOS technology mounted in the innovative leadless SMD plastic package, PowerFLAT™.

PD54003L's superior linearity performance makes it an ideal solution for portable radio.

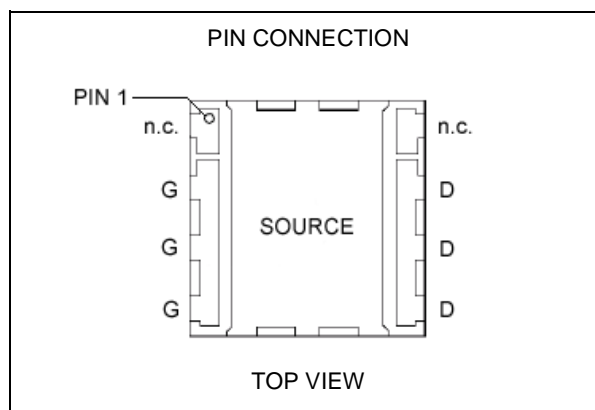

ABSOLUTE MAXIMUM RATINGS ($T_{CASE} = 25\text{ }^{\circ}\text{C}$)

Symbol	Parameter	Value	Unit
$V_{(BR)DSS}$	Drain-Source Voltage	25	V
V_{GS}	Gate-Source Voltage	-0.5 to +15	V
I_D	Drain Current	4	A
P_{DISS}	Power Dissipation (@ $T_c = 70\text{ }^{\circ}\text{C}$)	19.5	W
T_j	Max. Operating Junction Temperature	150	$^{\circ}\text{C}$
T_{STG}	Storage Temperature	-65 to +150	$^{\circ}\text{C}$

THERMAL DATA

$R_{th(j-c)}$	Junction -Case Thermal Resistance	4.1	$^{\circ}\text{C}/\text{W}$
---------------	-----------------------------------	-----	-----------------------------

PD54003L

ELECTRICAL SPECIFICATION (T_{CASE} = 25 °C)

STATIC (Per Section)

Symbol	Test Conditions		Min.	Typ.	Max.	Unit
I _{DSS}	V _{GS} = 0 V	V _{DS} = 25 V			1	μA
I _{GSS}	V _{GS} = 20 V	V _{DS} = 0 V			1	μA
V _{GS(Q)}	V _{DS} = 10 V	I _D = 50 mA	2.0		5.0	V
V _{DS(ON)}	V _{GS} = 10 V	I _D = 0.5 A		0.13	0.16	V
g _{FS}	V _{DS} = 10 V	I _D = 3.2 A		TBD		mho
C _{ISS}	V _{GS} = 0 V	V _{DS} = 7.5 V		54		pF
C _{OSS}	V _{GS} = 0 V	V _{DS} = 7.5 V		43		pF
C _{RSS}	V _{GS} = 0 V	V _{DS} = 7.5 V		4.0		pF

DYNAMIC

Symbol	Test Conditions		Min.	Typ.	Max.	Unit
P _{OUT}	V _{DD} = 7.5 V	I _{DQ} = 50 mA	f = 500 MHz	3		W
G _{PS}	V _{DD} = 7.5 V	I _{DQ} = 50 mA	P _{OUT} = 3 W	16	20	dB
η _D	V _{DD} = 7.5 V	I _{DQ} = 50 mA	P _{OUT} = 3 W	50	55	%
Load mismatch	V _{DD} = 9.5 V	I _{DQ} = 50 mA	P _{OUT} = 3 W	20:1		VSWR
	ALL PHASE ANGLES					

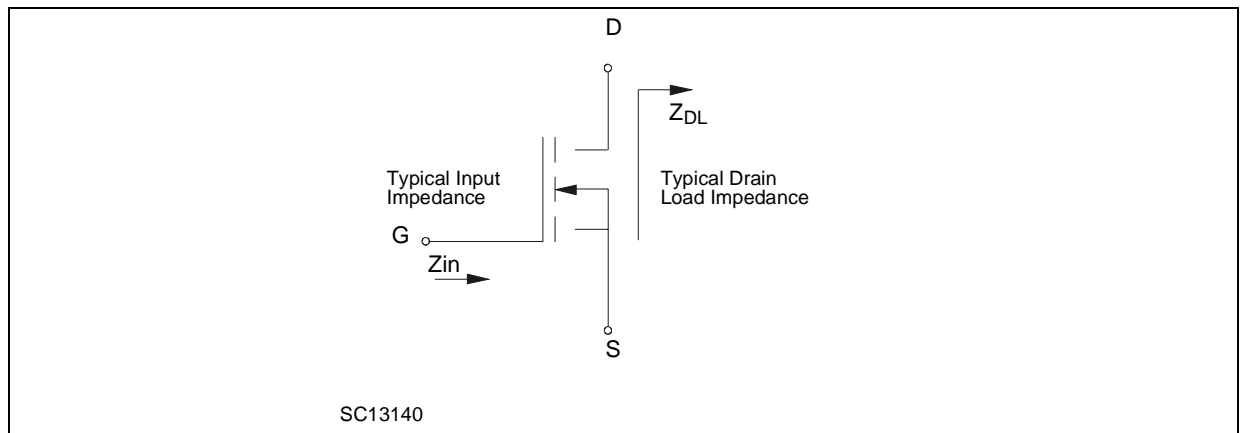

ESD PROTECTION CHARACTERISTICS

Test Conditions	Class
Human Body Model	2
Machine Model	M3

MOISTURE SENSITIVITY LEVEL

Test Methodology	Rating
J-STD-020B	MSL 3

TYPICAL PERFORMANCE

Capacitance Vs Supply Voltage

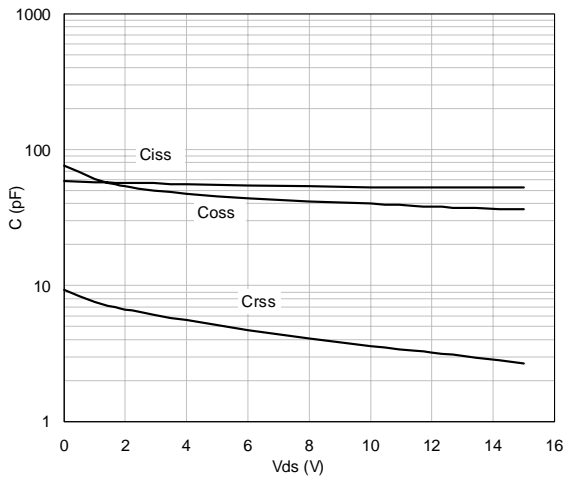

Output Power Vs Input Power

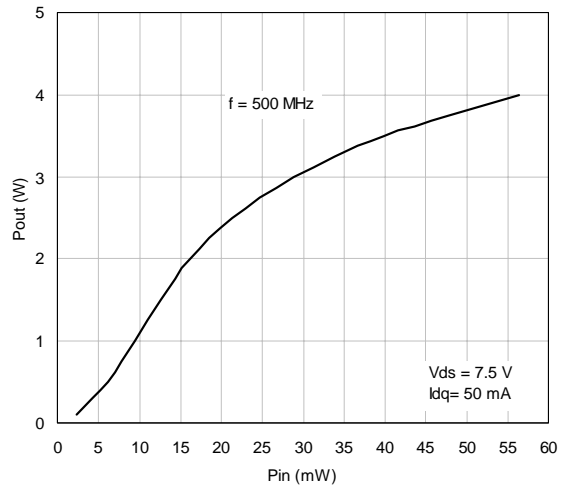

Power Gain Vs Output Power

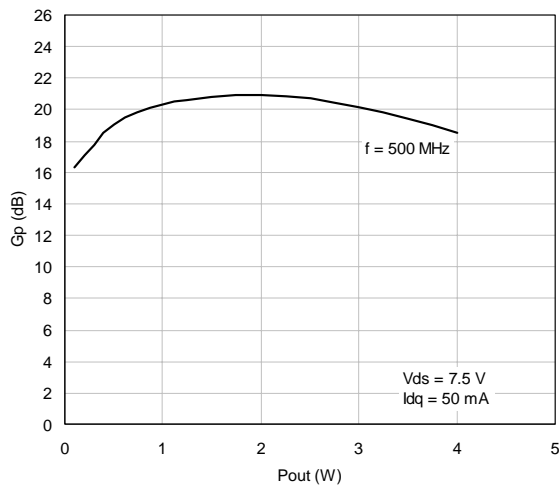

Efficiency Vs Output Power

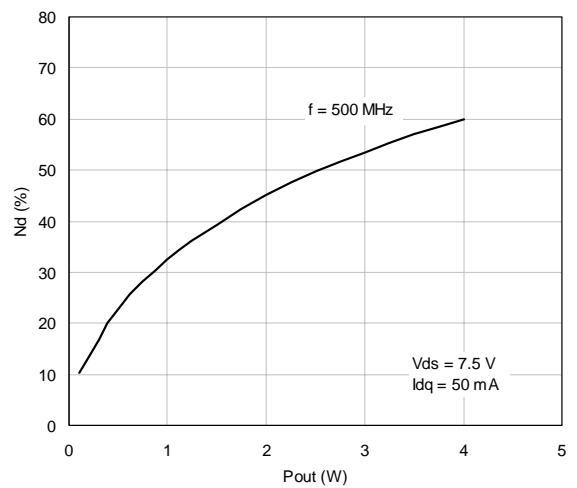

Output Power Vs Bias Current

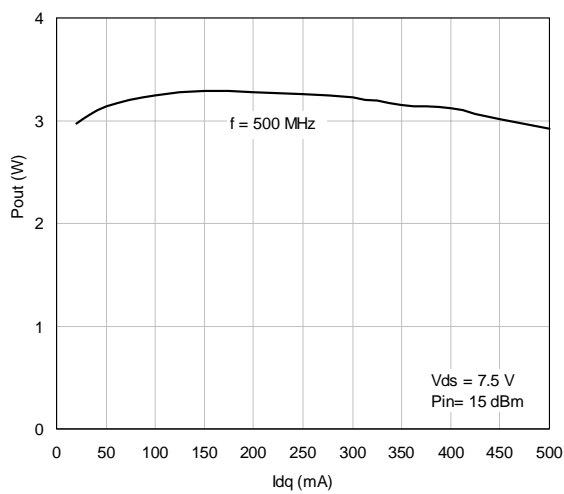

PD54003L

TYPICAL PERFORMANCE

Efficiency Vs Bias Current

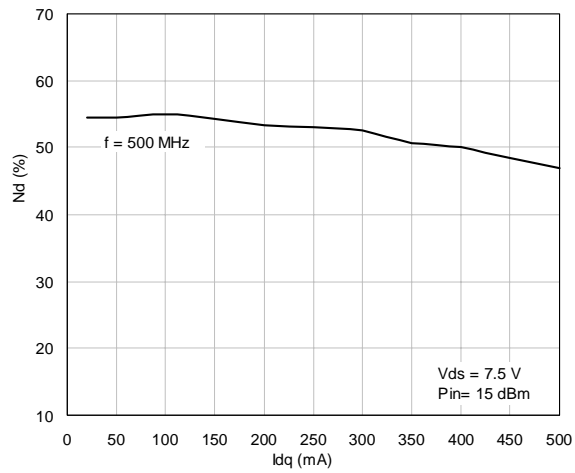

Output Power Vs Supply Voltage

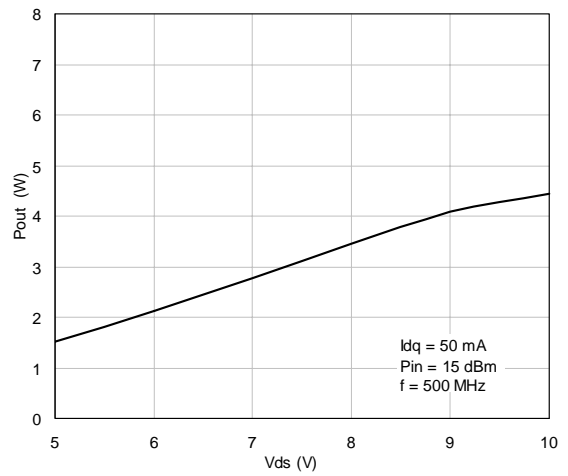

Output Power Vs Gate-Source Voltage

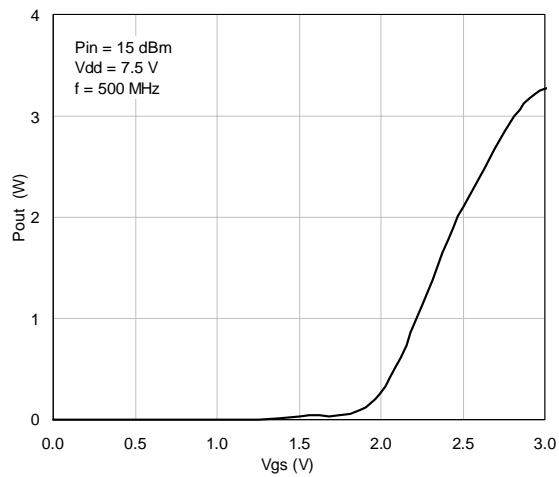

TYPICAL PERFORMANCE (BROADBAND)

Power Gain Vs Frequency

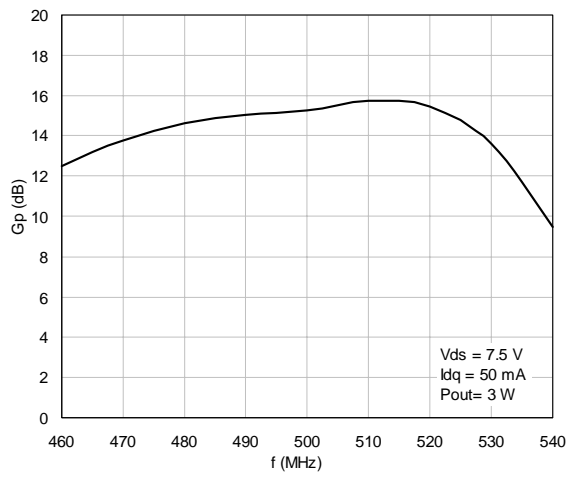

Efficiency Vs Frequency

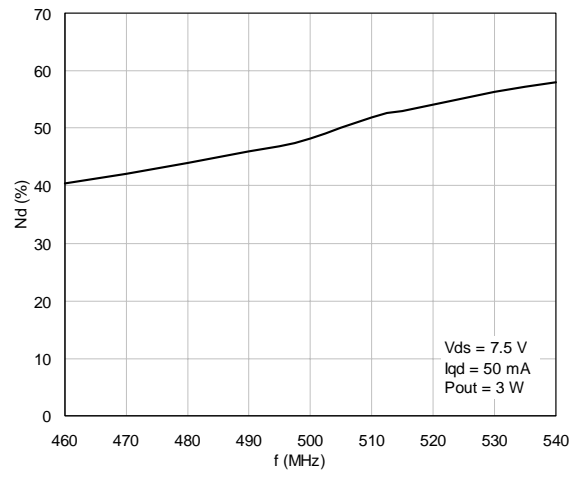

Return Loss Vs Frequency

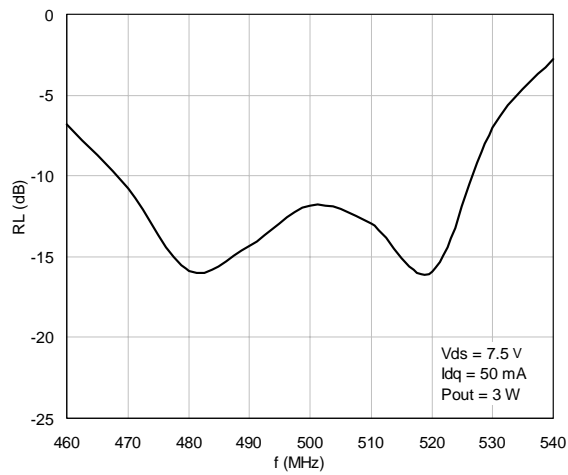

TAPE & REEL DIMENSIONS

	mm		
	MIN.	TYP.	MAX
Ao	5.15	5.25	5.35
Bo	5.15	5.25	5.35
Ko	1.0	1.1	1.2

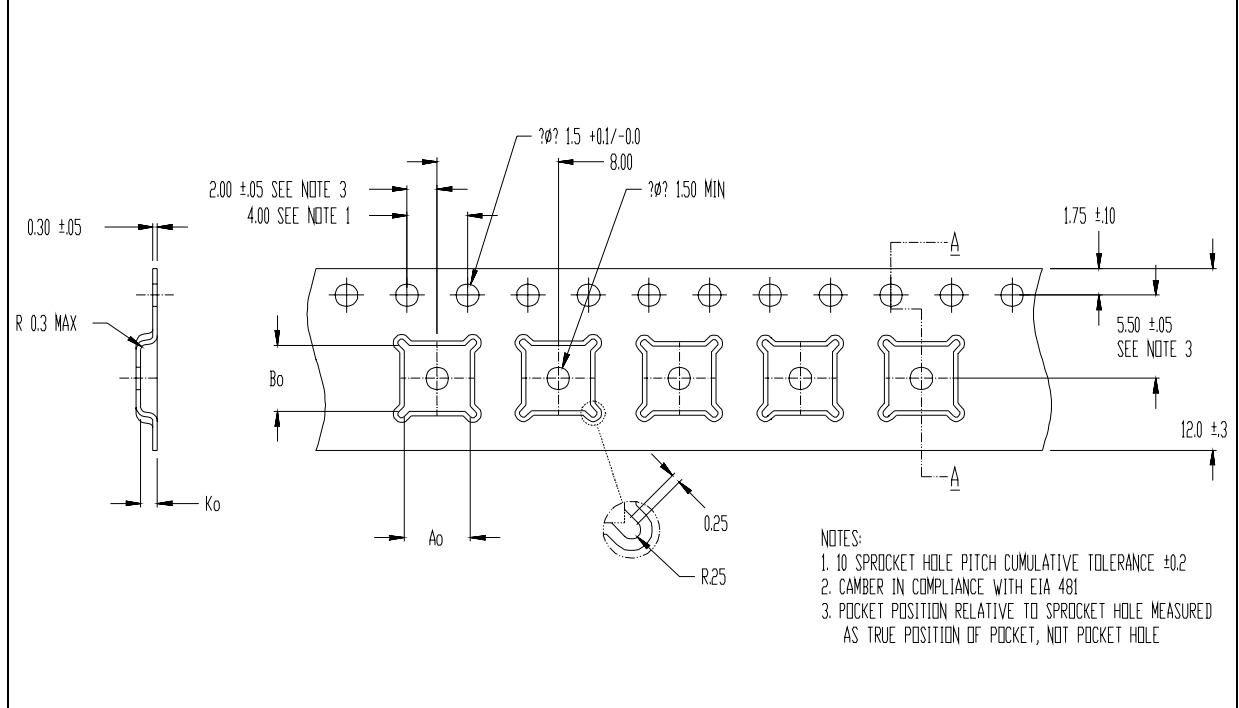

PowerFLAT™ MECHANICAL DATA

DIM.	mm			Inch		
	MIN.	TYP.	MAX	MIN.	TYP.	MAX
A		0.90	1.00		0.035	0.039
A1		0.02	0.05		0.001	0.002
A3		0.24			0.009	
AA	0.15	0.25	0.35	0.006	0.01	0.014
b	0.43	0.51	0.58	0.017	0.020	0.023
c	0.64	0.71	0.79	0.025	0.028	0.031
D		5.00			0.197	
d		0.30			0.011	
E		5.00			0.197	
E2	2.49	2.57	2.64	0.098	0.101	0.104
e		1.27			0.050	
f		3.37			0.132	
g		0.74			0.03	
h		0.21			0.008	

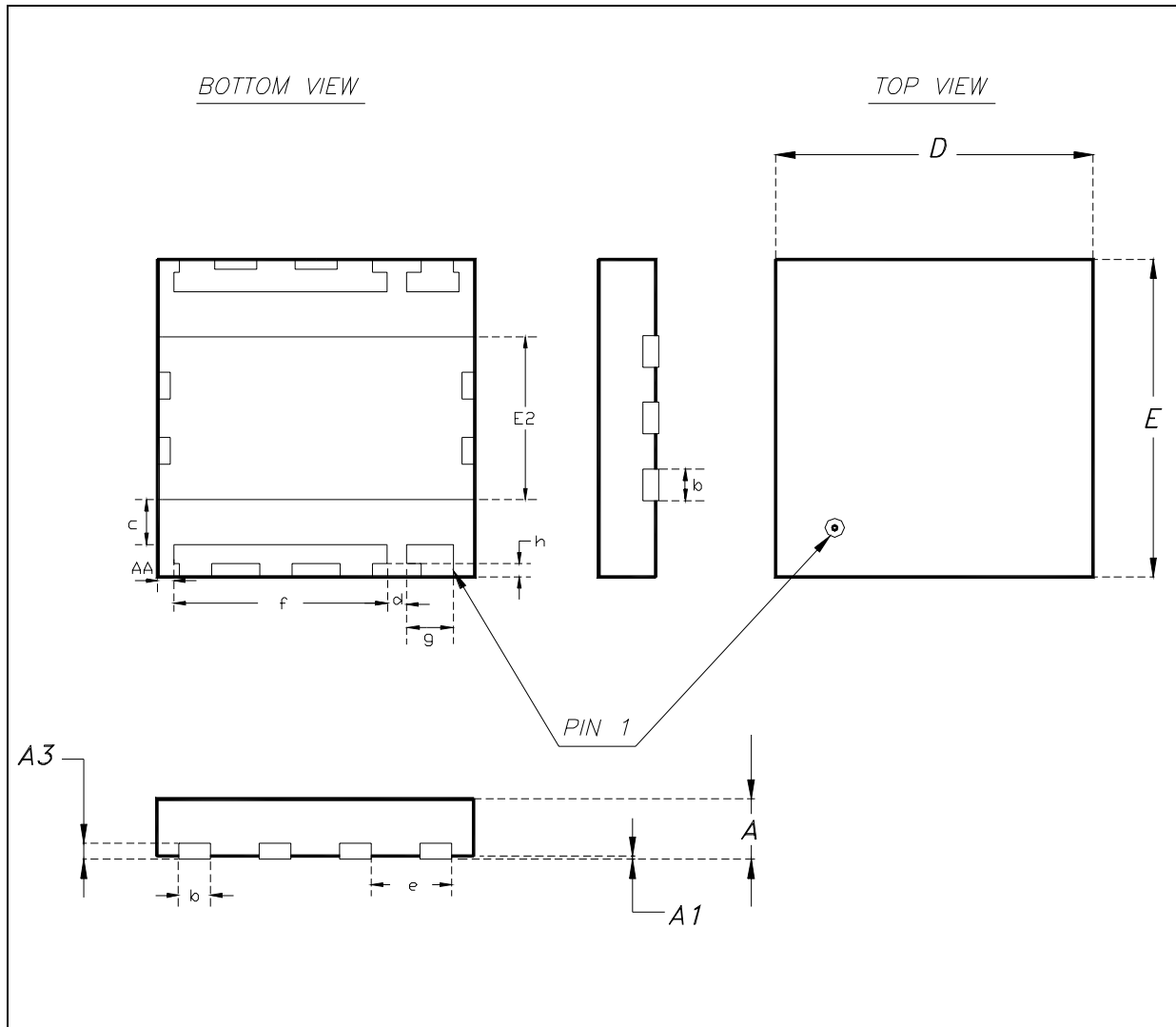

Information furnished is believed to be accurate and reliable. However, STMicroelectronics assumes no responsibility for the consequences of use of such information nor for any infringement of patents or other rights of third parties which may result from its use. No license is granted by implication or otherwise under any patent or patent rights of STMicroelectronics. Specifications mentioned in this publication are subject to change without notice. This publication supersedes and replaces all information previously supplied. STMicroelectronics products are not authorized for use as critical components in life support devices or systems without express written approval of STMicroelectronics.

The ST logo is registered trademark of STMicroelectronics
© 2003 STMicroelectronics - All Rights Reserved

All other names are the property of their respective owners.

STMicroelectronics GROUP OF COMPANIES
Australia - Brazil - Canada - China - Finland - France - Germany - Hong Kong - India - Israel - Italy - Japan -
Malaysia - Malta - Morocco - Singapore - Spain - Sweden - Switzerland - United Kingdom - U.S.A.
<http://www.st.com>