

THYRISTOR

400A Avg 800 Volts

PDT
PDH
PCH
PAT
PAH
4008

回路図 CIRCUIT

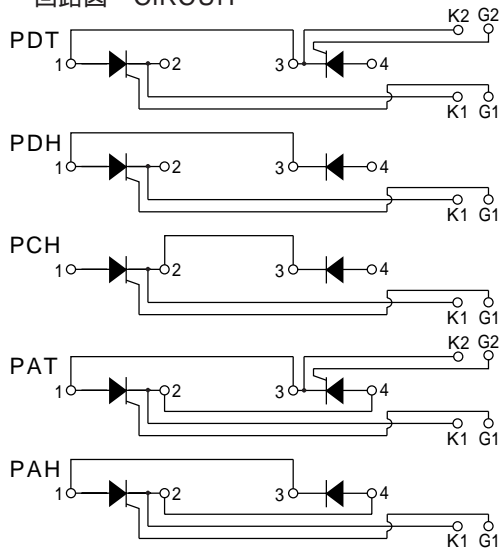

外形寸法図 OUTLINE DRAWING

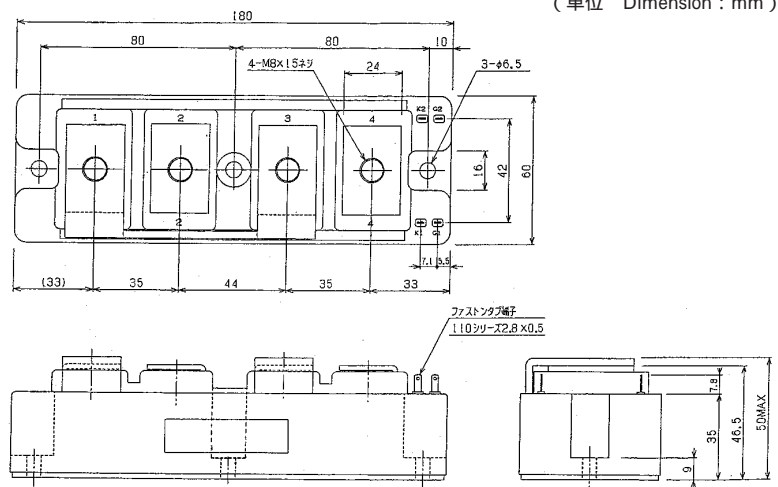

(単位 Dimension : mm)

最大定格 Maximum Ratings

| 項目 Parameter | 記号 Symbol | 耐压クラス Grade | | 単位 Unit |
|---|--------------|---|--|------------|
| | | PDT4008/PDH4008/PCH4008/PAT4008/PAH4008 | | |
| くり返しピークオフ電圧 Repetitive Peak Off-State Voltage | V_{DRM} | 800 | | V |
| 非くり返しピークオフ電圧 Non Repetitive Peak Off-State Voltage | V_{DSM} | 900 | | V |
| くり返しピーク逆電圧 Repetitive Peak Reverse Voltage | V_{RRM} | 800 | | V |
| 非くり返しピーク逆電圧 Non Repetitive Peak Reverse Voltage | V_{RSM} | 900 | | V |

| 項目 Parameter | 記号 Symbol | 条件 Conditions | 定格値 Max. Rated Value | 単位 Unit | | |
|---|------------------|---|-------------------------|------------|-----------|-----|
| 平均整流電流 Average Rectified Output Current | $I_{\alpha(AV)}$ | 商用周波数 180° 通電 Half Sine Wave $T_c = 63$ | 400 | A | | |
| 実効オン電流 RMS On-State Current | $I_{T(RMS)}$ | | 630 | A | | |
| サージオン電流 Surge On-State Current | I_{TSM} | 50Hz正弦半波, 1 サイクル, 非くり返し Half Sine Wave, 1Pulse, Non-Repetitive | 7500 | A | | |
| 電流二乗時間積 I Squared t | I^2t | 2 ~ 10ms | 281000 | A^2s | | |
| 臨界オン電流上昇率 Critical Rate of Rise of Turned-On Current | di/dt | $V_D = 2/3 V_{DRM}$, $I_{TM} = 2 \cdot I_{\alpha}$, $T_j = 125$ $I_G = 300mA$, $di_G/dt = 0.2A/\mu s$ | 100 | $A/\mu s$ | | |
| ピークゲート電力損失 Peak Gate Power | P_{GM} | | 5 | W | | |
| 平均ゲート電力損失 Average Gate Power | $P_{G(AV)}$ | | 1 | W | | |
| ピークゲート電流 Peak Gate Current | I_{GM} | | 2 | A | | |
| ピークゲート電圧 Peak Gate Voltage | V_{GM} | | 10 | V | | |
| ピークゲート逆電圧 Peak Gate Reverse Voltage | V_{RGM} | | 5 | V | | |
| 動作接合温度範囲 Operating Junction Temperature Range | T_{jw} | | - 40 ~ + 125 | | | |
| 保存温度範囲 Storage Temperature Range | T_{stg} | | - 40 ~ + 125 | | | |
| 絶縁耐圧 Isolation Voltage | V_{iso} | 端子 - ベース間, AC 1 分間 Terminal to Base, AC 1 min. | 2000 | V | | |
| 締付トルク Mounting Torque | ベース部 Mounting | F | サーマルコンパウンド塗布 Greased | M6 | 2.5 ~ 3.5 | N·m |
| | 主端子部 Terminal | | M8 | 9.0 ~ 10.0 | N·m | |

1 アーム当りの値 Value Per 1 Arm.

電気的特性 Electrical Characteristics

| 項目 Parameter | 記号 Symbol | 条件 Conditions | 特性値(最大) Maximum Value | | | 単位 Unit |
|---|---------------|--|--------------------------|------------|------------|------------|
| | | | 最小 Min. | 標準 Typ. | 最大 Max. | |
| ピークオフ電流 Peak Off-State Current | I_{DM} | $T_j=125$, $V_{DM}=V_{DRM}$ | | | 50 | mA |
| ピーク逆電流 Peak Reverse Current | I_{RM} | $T_j=125$, $V_{RM}=V_{RRM}$ | | | 50 | mA |
| ピークオン電圧 Peak On-State Voltage | V_{TM} | $T_j=25$, $I_{TM}=1300A$ | | | 1.35 | V |
| トリガゲート電流 Gate Current to Trigger | I_{GT} | $V_D=6V$, $I_T=1A$ | $T_j=-40$ | | 300 | mA |
| | | | $T_j=25$ | | 150 | mA |
| | | | $T_j=125$ | | 80 | mA |
| トリガゲート電圧 Gate Voltage to Trigger | V_{GT} | $V_D=6V$, $I_T=1A$ | $T_j=-40$ | | 5 | V |
| | | | $T_j=25$ | | 3 | V |
| | | | $T_j=125$ | | 2 | V |
| 非トリガゲート電圧 Gate Non-Trigger Voltage | V_{GD} | $T_j=125$, $V_D=2/3V_{DRM}$ | 0.25 | | | V |
| 臨界オフ電圧上昇率 Critical Rate of Rise of Off-State Voltage | dv/dt | $T_j=125$, $V_D=2/3V_{DRM}$ | 500 | | | V/ μ s |
| ターンオフ時間 Turn-Off Time | t_q | $T_j=125$, $I_{TM}=I_o$, $V_D=2/3V_{DRM}$ $dv/dt=20V/\mu$ s , $V_R=100V$, $-di/dt=20A/\mu$ s | | | | μ s |
| ターンオン時間 Turn-On Time | t_{gt} | | | 6 | | μ s |
| 遅れ時間 Delay Time | t_d | $T_j=25$, $V_D=2/3V_{DRM}$ $I_G=300mA$, $di_G/dt=0.2A/\mu$ s | | 2 | | μ s |
| 立上がり時間 Rise Time | t_r | | | 4 | | μ s |
| ラッチング電流 Latching Current | I_L | $T_j=25$ | | 150 | | mA |
| 保持電流 Holding Current | I_H | $T_j=25$ | | 60 | | mA |
| 熱抵抗 Thermal Resistance | $R_{th(j-c)}$ | 接合部 - ケース間 Junction to Case | | | 0.12 | /W |
| 接触熱抵抗 Thermal Resistance | $R_{th(c-f)}$ | ケース - フィン間, サーマルコンパウンド塗布 Case to Fin, Greased | | | 0.05 | /W |

質量...約1350g
Approximate Weight

1 アーム当りの値 Value Per 1 Arm.

オン電圧特性
ON-STATE CURRENT VS. VOLTAGE

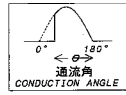
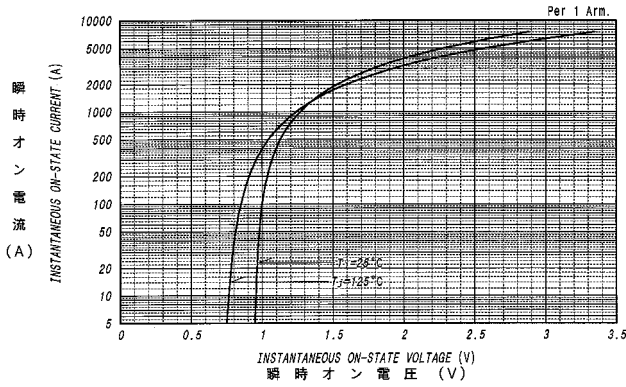

平均オン電力損失特性
AVERAGE ON-STATE POWER DISSIPATION
for SINUSOIDAL CURRENT WAVEFORM

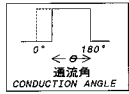
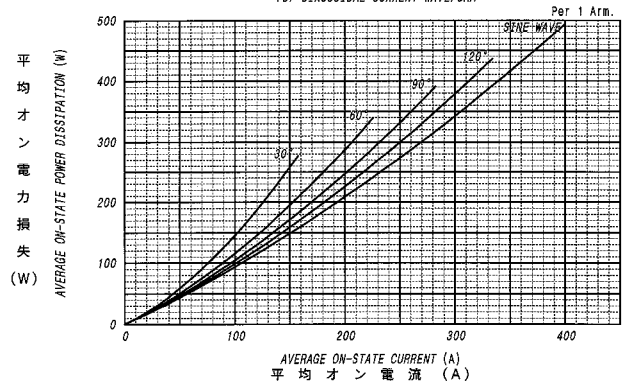

平均オン電力損失特性
AVERAGE ON-STATE POWER DISSIPATION
for RECTANGULAR CURRENT WAVEFORM

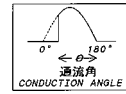
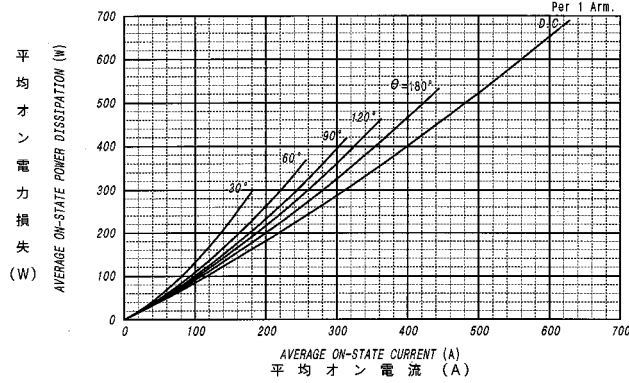

平均オン電流 - ケース温度定格
AVERAGE ON-STATE CURRENT VS. CASE TEMPERATURE

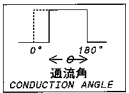
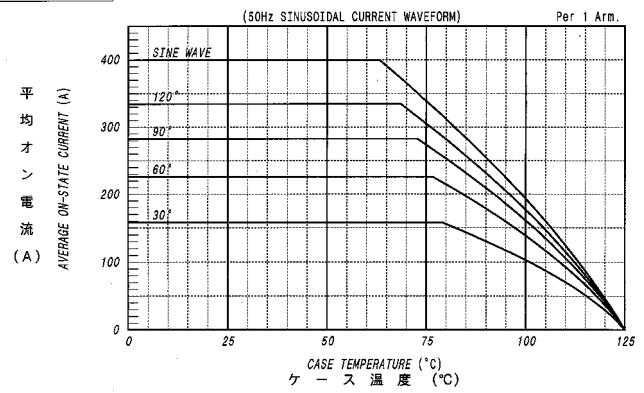

平均オン電流 - ケース温度定格
AVERAGE ON-STATE CURRENT VS. CASE TEMPERATURE

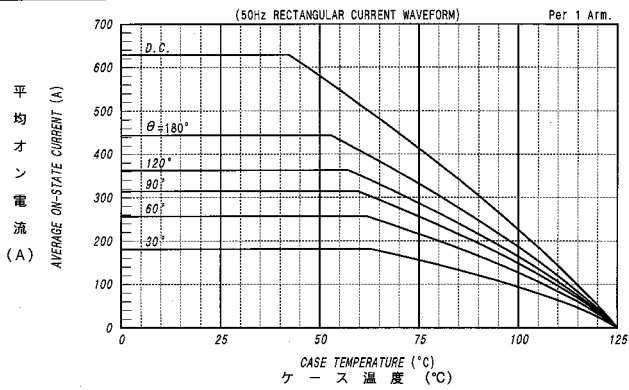

サージオン電流定格
SURGE CURRENT RATINGS

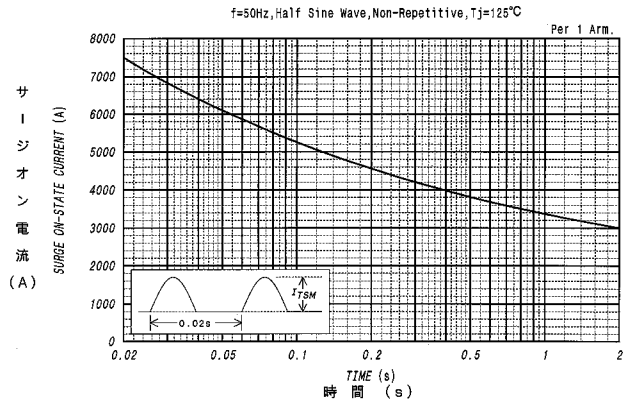

ゲート特性
GATE CHARACTERISTICS

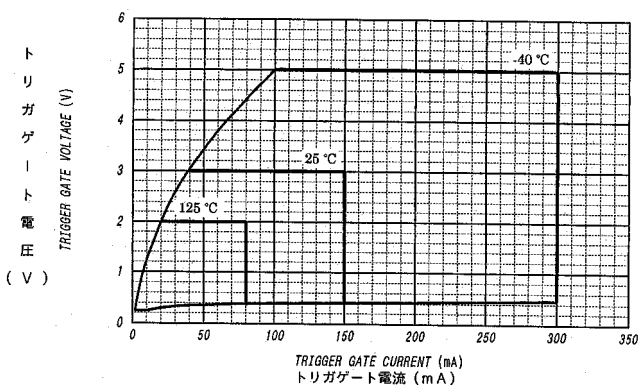

ゲート定格
GATE RATINGS

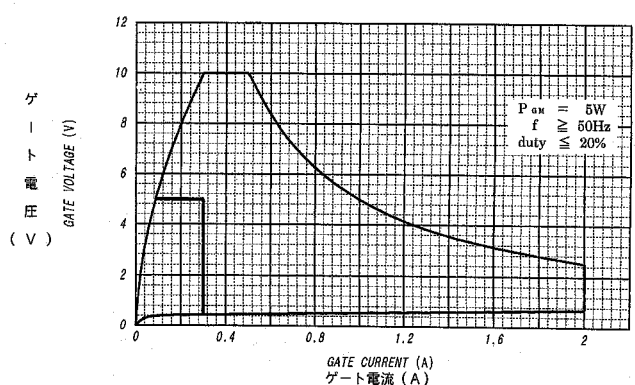

過渡熱抵抗特性
 MAXIMUM TRANSIENT THERMAL IMPEDANCE
 Junction to Case

