

The PDSP16330 is a high speed digital CMOS IC that converts Cartesian data (Real and Imaginary) into Polar form (Magnitude and Phase), at rates up to 20MHz. Cartesian 16+16 bit 2's complement or Sign-Magnitude data is converted into 16bit Phase format. The Magnitude output may be scaled in amplitude by powers of 2. The Phase output represents a full $2 \times \pi$ field to eliminate phase ambiguities.

Polyimide is used as an inter-layer dielectric and as glassivation.

The PDSP16330 is offered in three speed grades: a basic 10MHz part (PDSP16330), a 20MHz version (PDSP16330A) and a 25MHz version (PDSP16330B). A MIL-STD-883 version is also detailed in a separate datasheet.

FEATURES

- 25MHz Cartesian to Polar Conversion
- 16-Bit Cartesian Inputs
- 16-Bit Magnitude Output
- 12-Bit Phase Output
- 2's Complement or Sign-Magnitude Input Formats
- Three-state Outputs and Independent Data Enables Simplify System Interfacing
- Magnitude Scaling Facility with Overflow Flag
- Less than 400 mW Power Dissipation at 10MHz
- 84-pin PGA or 100 pin QFP Package or 84 LCC

APPLICATIONS

- Digital Signal Processing
- Digital Radio
- Radar Processing
- Sonar Processing
- Robotics

ORDERING INFORMATION

Commercial (0°C to +70°C)

PDSP16330A CO AC (20MHz - PGA Package)
 PDSP16330B CO AC (25MHz - PGA Package)

Industrial (-40°C to +85°C)

PDSP16330A BO AC 20MHz - PGA Package
 PDSP16330A/IG/GC1R 20MHz - GC Package
 PDSP16330B BO AC 25MHz - PGA Package

Military (-55°C to +125°C)

PDSP16330A AO AC 20MHz - PGA Package
 PDSP16330/MC/GC1R 10MHz - GC Package
 Mil 883C Screened

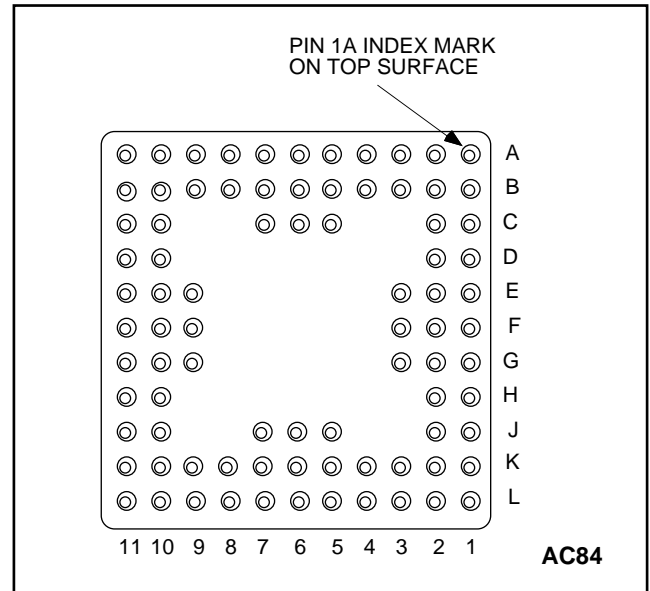

Fig.1 Pin connections - bottom view (PGA)

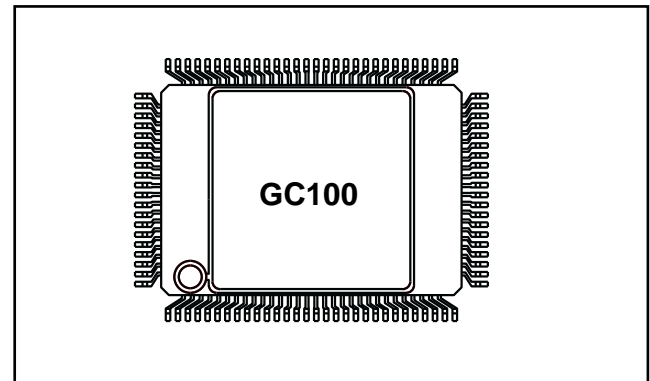

Fig.2 Pin connections - QFP Package

ASSOCIATED PRODUCTS

- PDSP16112** 16 X 12 Complex Multiplier
- PDSP16116** 16 X 16 Complex Multiplier
- PDSP16318** Complex Accumulator
- PDSP16350** I/Q Splitter and NCO
- PDSP16510A** Stand Alone FFT Processor

PDSP16330/A/B

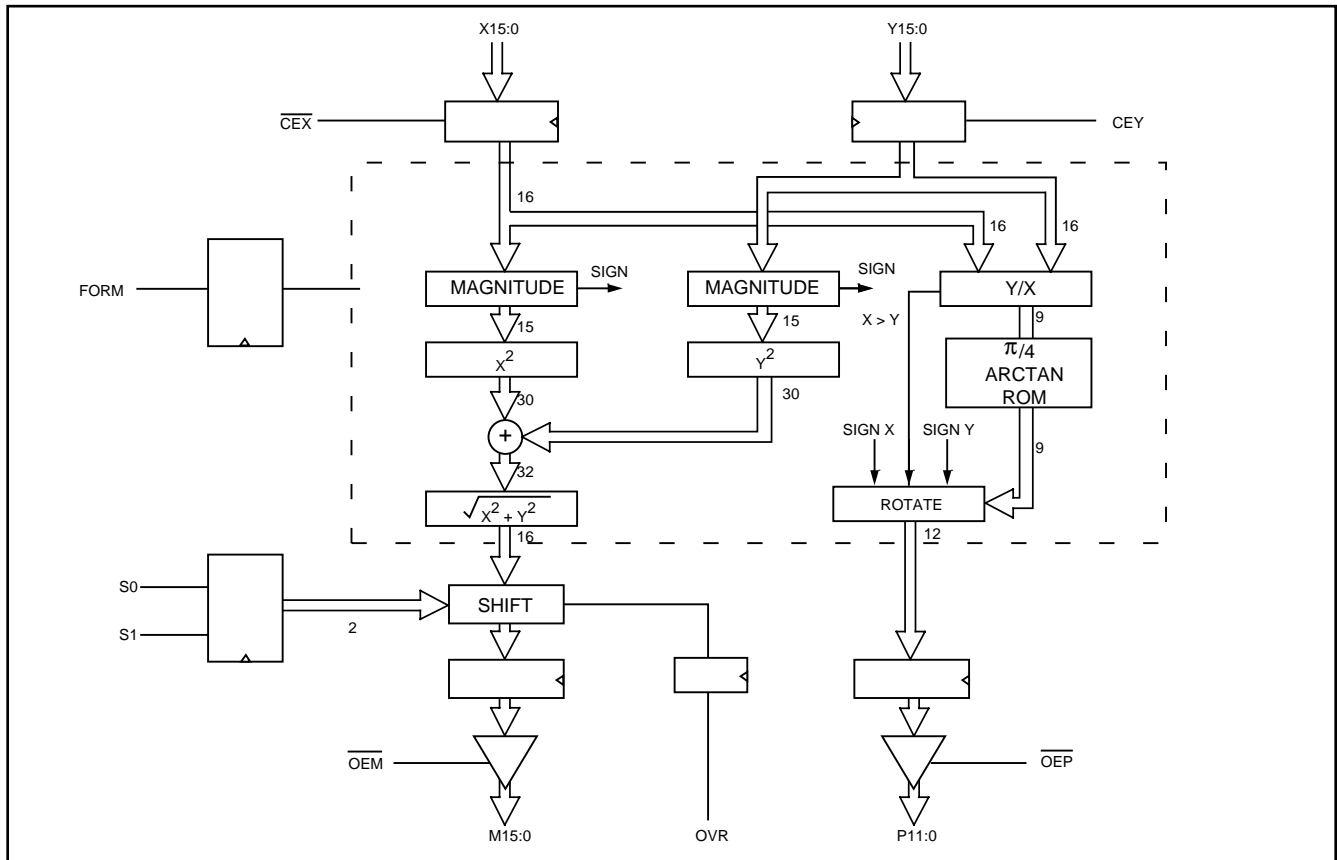

Fig.2 Block diagram

FUNCTIONAL DESCRIPTION

The PDSP16330 converts incoming Cartesian Data into the equivalent Polar Values. The device accepts new 16 + 16 bit complex data every cycle, and delivers a 16 bit + 12 bit Polar equivalent after 24 clock cycles. The input data can be in 2s' Complement or Sign Magnitude format selected via the FORM input. The output is in a magnitude format for both the Magnitude output and the Phase. Phase data is zero for data with a zero Y input and positive X, and is 400 hex for zero X data and positive Y, is 800 hex for zero Y data and negative X, and is C00 hex for zero X and negative Y. The LSB weighting (bit 0) is $2 \times \pi/4096$ radians. The 16 bit Magnitude result may be scaled by shifting one, two, or three places in the more significant direction, effectively multiplying the Magnitude result by 2, 4 or 8 respectively. Any of these shifts can under certain conditions cause an invalid result to be output from the device. Under these circumstances the OVR output will become active. The PDSP16330 has independent clock enables and three state output controls for all ports.

FORM

This input selects the format of the X and Y input data. A low level on FORM indicates that the Input data is twos' complement format (Note: input data 8000 hex is not valid in 2s' complement mode). This input refers to the format of the current Input data and may be changed on a per cycle basis if desired. The level of FORM is latched at the same time as the data to which it refers.

S1-0

These inputs select the scaling factor to be applied to the Magnitude output. They are latched by the rising edge of CLK and determine the scaling of the output in the cycle after they are loaded into the device. The scale factor applied is determined by the table. Should the scaling factor applied cause an invalid Magnitude result to be output on the M Port, then the OVR Flag will become active for the period that the M Port output is invalid.

S1	S0	Scaling Factor
0	0	x1
0	1	x2
1	0	x4
1	1	x8

The output number range is from 0 to 2 when the scaling factor is set at x1.

PIN DESCRIPTIONS

Symbol	Pin Name and Description
CLK	Clock: Common Clock to device Registers. Register contents change on the rising edge of clock. Both pins must be connected.
$\overline{CE}X$	Clock Enable: Clock Enable for X Port. The clock to the X port is enabled by a low level.
$\overline{CE}Y$	Clock Enable: Clock Enable for Y Port. The clock to the Y port is enabled by a low level.
X15-X0	X Data Input Data presented to this input is loaded into the device by the rising edge of CLK. X15 is the MSB
Y15-Y0	Y Data Input Data presented to this input is loaded into the device by the rising edge of CLK. Y15 is the MSB
M15-M0	M Data Output: Magnitude data generated by the device is output on this port. Data changes on the rising edge of CLK, M15 is the MSB. The weighting of M15 is determined by the Scale factor selected .
P11-P0	P Data Output: Phase data generated by the device is output on this port. Data changes on the rising edge of CLK, P11 is the MSB. The weighting of P11 is π radians.
$\overline{OE}M$	Output Enable: Output Enable for M Port. The M Port is in a high impedance state when this input is high.
$\overline{OE}P$	Output Enable: Output Enable for P Port. The P Port is in a high impedance state when this input is high.
FORM	Format Select This input selects the format of the Cartesian Data input on the X and Y ports. This input is latched by the rising edge of CLK, and is applied at the same time as the data to which it refers. A low level indicates that two's complement data is applied, a high indicates Sign-Magnitude
S1-S0	Scaling Control: Control input for scaling of Magnitude Data. This input is latched by the rising edge of CLK, and determines the scaling to be applied to the Magnitude result. The Scaling is applied to the output data in the cycle following the cycle in which the control was latched.
OVR	Overflow: Overflow flag. This signal becomes active if the scaling currently selected causes an invalid value to be presented to the Magnitude output.
Vcc	+5V supply. All Vcc pins must be connected.
GND	0V supply. All GND pins must be connected.

INPUT DATA RANGE

2's Complement	Sign Magnitude
7FFF	7FFF
.	.
.	.
.	.
0001	0001
0000	0000
FFFF	8000
.	.
.	.
.	.
8001	FFF

PDSP16330/A/B

PIN FUNCTION

Pin No. AC	GC	Function	Pin No. AC	GC	Function	Pin No. AC	GC	Function
F3	91	M7	L9	23	YO	A9	59	X1
G3	92	M6	L10	24	\overline{CEY}	B8	60	X2
G1	93	M5	K9	25	CLK	A8	61	X3
G2	94	M4	L11	26	V _{cc}	B6	62	X4
F1	95	M3	K10	31	GND	B7	63	X5
H1	96	M2	J10	32	GND	A7	64	X6
H2	97	M1	K11	33	GND	C7	65	X7
J1	98	M0	J11	34	GND	C6	66	X8
K1	99	S0	H10	35	GND	A6	67	X9
J2	100	S1	H11	36	GND	A5	68	X10
L1	1	GND	F10	37	GND	B5	69	X11
K2	6	V _{cc}	G10	38	\overline{OEP}	C5	70	X12
K3	7	FORM	G11	39	P0	A4	71	X13
L2	8	Y15	G9	40	P1	B4	72	X14
L3	9	Y14	F9	41	P2	A3	73	X15
K4	10	Y13	F11	42	P3	A2	74	CLK
L4	11	Y12	E11	43	P4	B3	75	OVR
J5	12	Y11	E10	44	P5	A1	76	V _{cc}
K5	13	Y10	E9	45	P6	B2	81	GND
L5	14	Y9	D11	46	P7	C2	82	\overline{OEM}
K6	15	Y8	D10	47	P8	B1	83	M15
J6	16	Y7	C11	48	P9	C1	84	M14
J7	17	Y6	B11	49	P10	D2	85	M13
L7	18	Y5	C10	50	P11	D1	86	M12
K7	19	Y4	A11	51	GND	E3	87	M11
L6	20	Y3	B10	52	V _{cc}	E2	88	M10
L8	21	Y2	B9	57	\overline{CEX}	E1	89	M9
K8	22	Y1	A10	58	X0	F2	90	M8

ELECTRICAL CHARACTERISTICS

Test conditions (unless otherwise stated): T_{amb} (Commercial) = 0°C to +70°C, T_{amb} (Industrial) = -40°C to +85°C
V_{cc} (Commercial) = 5.0V ± 5%, V_{cc} (Industrial and Military) = 5.0V ± 1%, GND = 0V

STATIC CHARACTERISTICS

Characteristic	Symbol	Value			Units	Sub-group	Conditions
		Min.	Typ.	Max.			
* Output high voltage	V _{OH}	2.4			V	1,2,3	IOH = 3.2mA IOL = -3.2mA
* Output low voltage	V _{OL}			0.6	V	1,2,3	
* Input high voltage (CMOS)	V _{IH}	3.0			V	1,2,3	Inputs \overline{CEX} , \overline{CEY} and CLK only Inputs \overline{CEX} , \overline{CEY} and CLK only
* Input low voltage (CMOS)	V _{IL}			1.0	V	1,2,3	
* Input high voltage (TTL)	V _{IH}	2.2			V	1,2,3	All other inputs
* Input low voltage (TTL)	V _{IL}			0.8	V	1,2,3	
* Input leakage current (Note 1)	I _{IL}	-10		+ 120	μA	1,2,3	GND ≤ V _{IN} ≤ V _{CC}
† Input capacitance	C _{IN}		10		pF		
* Output leakage current	I _{oz}	-50		+ 50	μA	1,2,3	GND ≤ V _{IN} ≤ V _{CC}
† Output SC current	I _{OS}	-50		230	mA		V _{cc} = Max

NOTES

1. All inputs except clock inputs have high value pull-down resistors
2. All parameters marked * are tested during production. Parameters marked † are guaranteed by design and characterisation.

SWITCHING CHARACTERISTICS

Characteristic	Value						Units	Conditions	
	PDSP16330		PDSP16330A		PDSP16330B				
	Min.	Max.	Min.	Max.	Min.	Max.			
† Input data setup to clock rising edge	15		12		12		ns	2 x LSTTL + 20pF	
† Input data Hold after clock rising edge	2		2		2		ns		
† \overline{CEX} , \overline{CEY} Setup to clock rising edge	30		12		12		ns		
† \overline{CEX} , \overline{CEY} Hold after clock rising edge	0		0		0		ns		
† FORM, S1:0 Setup to clock rising edge	15		12		12		ns		
† FORM, S1:0 Hold after clock rising edge	7		2		2		ns		
† Clock rising edge to valid data	5	40	5	25	5	25	ns		
* Clock period	100		50		40		ns		
† Clock high time	25		15		15		ns		
† Clock low time	25		15		15		ns		
† Latency	24	24	24	24	24	24	cycles		
† \overline{OEM} , \overline{OEP} low to data high data valid		30		25	25		ns		2 x LSTTL + 20pF
† \overline{OEM} , \overline{OEP} low to data low data valid		30		25	25		ns		2 x LSTTL + 20pF
† \overline{OEM} , \overline{OEP} high to data high impedance		30		25	25		ns		2 x LSTTL + 20pF
† \overline{OEM} , \overline{OEP} low to data high impedance		30		25	25		ns		2 x LSTTL + 20pF
† Vcc current (TTL input levels)		110		180	225		mA	V _{CC} = Max Outputs unloaded Clock freq. = Max	
† Vcc current (CMOS input levels)		70		120	150		mA	V _{CC} = Max Outputs unloaded Clock freq. = Max	

NOTES

- LSTTL is equivalent to $I_{OH} = 20\mu A$, $I_{OL} = -0.4mA$
- Current is defined as negative into the device
- CMOS input levels are defined as: $V_{IH} = V_{DD} - 0.5V$, $V_{IL} = +0.5V$
- All parameters marked * are tested during production.
Parameters marked † are guaranteed by design and characterisation.
- All timings are dependent on silicon speed. This speed is tested by measuring clock period.
This guarantees all other timings by characterisation and design.

ABSOLUTE MAXIMUM RATINGS

Supply voltage, V_{CC}	-0.5V to + 7.0V
Input voltage, V_{IN}	-0.5V to VCC + 0.5V
Output voltage, V_{OUT}	-0.5V to VCC + 0.5V
Clamp diode current per pin, I_K (see Note 2)	±18mA
Static discharge voltage (HMB), V_{STAT}	500V
Storage temperature, T_{stg}	-65°C to + 150°C
Ambient temperature with power applied T_{amb} :	
Commercial	0°C to + 70°C
Industrial	-40°C to + 85°C
Military	-55 °C to + 125°C
Package power dissipation P_{TOT}	1200mW
Junction temperature	150°C

THERMAL CHARACTERISTICS

Package Type	$\theta_{JC}^{\circ C/W}$	$\theta_{JA}^{\circ C/W}$
AC	12	36
GC	12	35

NOTES

- Exceeding these ratings may cause permanent damage. Functional operation under these conditions is not implied.
- Maximum dissipation or 1 second should not be exceeded; only one output to be tested at any one time.
- Exposure to Absolute Maximum Ratings for extended periods may affect device reliability.

PDSP16330/A/B

Test	Waveform - measurement level
Delay from output high to output high impedance	
Delay from output low to output high impedance	
Delay from output high impedance to Output low	
Delay from output high impedance to Output high	
<p>NOTES</p> <ol style="list-style-type: none"> V_H - Voltage reached when output driven high V_L - Voltage reached when output driven low <div style="text-align: center;">  </div>	

Fig.3 Three state delay measurement load



**For more information about all Zarlink products
visit our Web Site at
www.zarlink.com**

Information relating to products and services furnished herein by Zarlink Semiconductor Inc. or its subsidiaries (collectively "Zarlink") is believed to be reliable. However, Zarlink assumes no liability for errors that may appear in this publication, or for liability otherwise arising from the application or use of any such information, product or service or for any infringement of patents or other intellectual property rights owned by third parties which may result from such application or use. Neither the supply of such information or purchase of product or service conveys any license, either express or implied, under patents or other intellectual property rights owned by Zarlink or licensed from third parties by Zarlink, whatsoever. Purchasers of products are also hereby notified that the use of product in certain ways or in combination with Zarlink, or non-Zarlink furnished goods or services may infringe patents or other intellectual property rights owned by Zarlink.

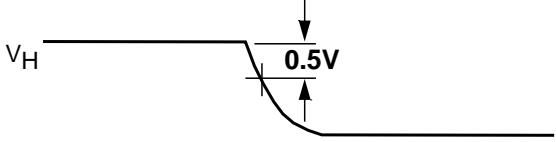
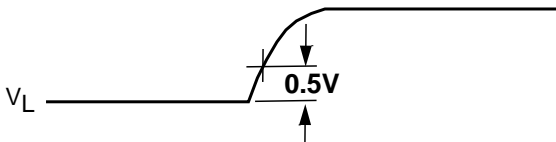
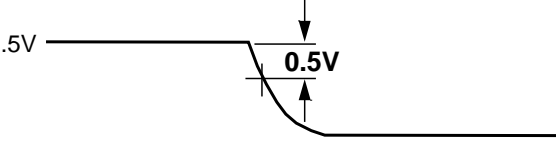
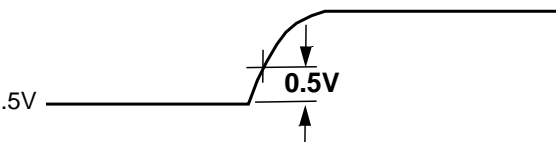
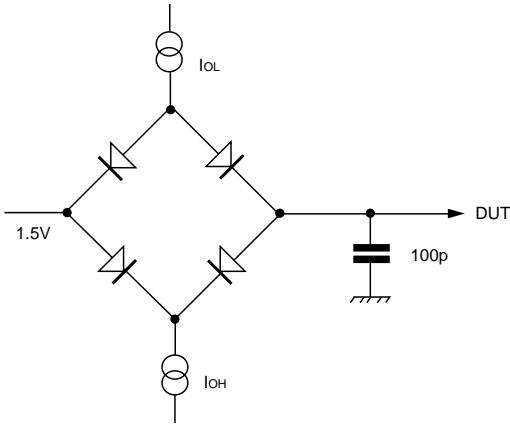
This publication is issued to provide information only and (unless agreed by Zarlink in writing) may not be used, applied or reproduced for any purpose nor form part of any order or contract nor to be regarded as a representation relating to the products or services concerned. The products, their specifications, services and other information appearing in this publication are subject to change by Zarlink without notice. No warranty or guarantee express or implied is made regarding the capability, performance or suitability of any product or service. Information concerning possible methods of use is provided as a guide only and does not constitute any guarantee that such methods of use will be satisfactory in a specific piece of equipment. It is the user's responsibility to fully determine the performance and suitability of any equipment using such information and to ensure that any publication or data used is up to date and has not been superseded. Manufacturing does not necessarily include testing of all functions or parameters. These products are not suitable for use in any medical products whose failure to perform may result in significant injury or death to the user. All products and materials are sold and services provided subject to Zarlink's conditions of sale which are available on request.

Purchase of Zarlink's I²C components conveys a licence under the Philips I²C Patent rights to use these components in and I²C System, provided that the system conforms to the I²C Standard Specification as defined by Philips.

Zarlink, ZL and the Zarlink Semiconductor logo are trademarks of Zarlink Semiconductor Inc.

Copyright Zarlink Semiconductor Inc. All Rights Reserved.

TECHNICAL DOCUMENTATION - NOT FOR RESALE
