

## 50A 1/2" WASHER LEAD PRESS-FIT DIODE

### Features

- Diffused Junction
- Low Leakage
- Low Cost
- High Surge Current Capability
- Typical IR less than 5.0μA

### Mechanical Data

- Case: Copper Case and Components Hermetically Sealed
- Terminals: Insulated Wire with Washer Lead
- Polarity: Cathode to Case (Reverse Units Are Available Upon Request and Are Designated By A "R" Suffix, i.e. PFW5002R or PFW5004R)
- Polarity: Red Color Equals Standard, Black Color Equals Reverse Polarity
- Mounting Position: Any
- **Lead Free: For RoHS / Lead Free Version, Add "-LF" Suffix to Part Number, See Page 2**

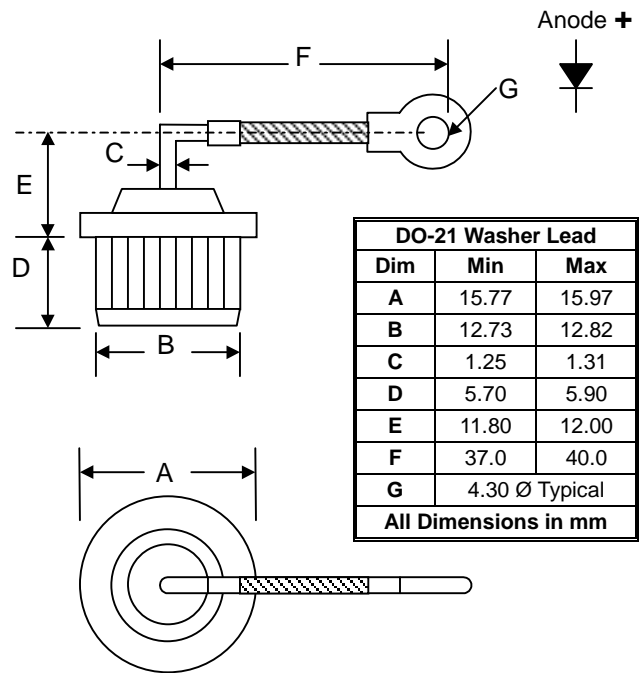

### Maximum Ratings and Electrical Characteristics @T<sub>A</sub>=25°C unless otherwise specified

Single Phase, half wave, 60Hz, resistive or inductive load.  
 For capacitive load, derate current by 20%.

Characteristic	Symbol	PFW 5000	PFW 5001	PFW 5002	PFW 5003	PFW 5004	PFW 5005	PFW 5006	Unit
Peak Repetitive Reverse Voltage	V <sub>RRM</sub>								V
Working Peak Reverse Voltage	V <sub>VRWM</sub>	50	100	200	300	400	500	600	
DC Blocking Voltage	V <sub>R</sub>								
RMS Reverse Voltage	V <sub>R(RMS)</sub>	35	70	140	210	280	350	420	V
Average Rectified Output Current @T <sub>C</sub> = 150°C	I <sub>O</sub>	50							A
Non-Repetitive Peak Forward Surge Current 8.3ms Single half sine-wave superimposed on rated load (JEDEC Method)	I <sub>FSM</sub>	500							A
Forward Voltage @I <sub>F</sub> = 50A	V <sub>FM</sub>	1.0							V
Peak Reverse Current @T <sub>A</sub> = 25°C	I <sub>RM</sub>	5.0							μA
At Rated DC Blocking Voltage @T <sub>A</sub> = 100°C		500							
Typical Junction Capacitance (Note 1)	C <sub>j</sub>	400							pF
Typical Thermal Resistance (Note 2)	R <sub>θJC</sub>	1.0							°C/W
Operating and Storage Temperature Range	T <sub>J</sub> , T <sub>STG</sub>	-65 to +175							°C

Note: 1. Measured at 1.0 MHz and applied reverse voltage of 4.0V D.C.  
 2. Thermal Resistance: Junction to case, single side cooled.

## ORDERING INFORMATION

Product No.	Package Type	Shipping Quantity
PFW5000	DO-21 Washer Lead Press-Fit	100 Units/Box
PFW5001	DO-21 Washer Lead Press-Fit	100 Units/Box
PFW5002	DO-21 Washer Lead Press-Fit	100 Units/Box
PFW5003	DO-21 Washer Lead Press-Fit	100 Units/Box
PFW5004	DO-21 Washer Lead Press-Fit	100 Units/Box
PFW5005	DO-21 Washer Lead Press-Fit	100 Units/Box
PFW5006	DO-21 Washer Lead Press-Fit	100 Units/Box

1. Shipping quantity given is for minimum packing quantity only. For minimum order quantity, please consult the Sales Department.
2. **To order Lead Free version (with Lead Free finish), add "-LF" suffix to part number above. For example, PFW5000-LF.**

Won-Top Electronics Co., Ltd (WTE) has checked all information carefully and believes it to be correct and accurate. However, WTE cannot assume any responsibility for inaccuracies. Furthermore, this information does not give the purchaser of semiconductor devices any license under patent rights to manufacturer. WTE reserves the right to change any or all information herein without further notice.

**WARNING:** DO NOT USE IN LIFE SUPPORT EQUIPMENT. WTE power semiconductor products are not authorized for use as critical components in life support devices or systems without the express written approval.

**Won-Top Electronics Co., Ltd.**

No. 44 Yu Kang North 3rd Road, Chine Chen Dist., Kaohsiung, Taiwan

**Phone:** 886-7-822-5408 or 886-7-822-5410

**Fax:** 886-7-822-5417

**Email:** sales@wontop.com

**Internet:** <http://www.wontop.com>

*We power your everyday.*