

**Features**

- Low Cost
- Industry Standard 1 Inch Drop-in package
- Designed for Wireless Telecom Systems
- 50 Ohms Characteristic Impedance

**Description**

The PI0860DG-21 is a small low cost drop-in Isolator designed for applications in high performance linear power amplifiers for wireless base stations. These Isolators feature a robust construction for high reliability with excellent IMD performance. CCW rotation and special tab offsets available on request. S-Parameters are also available on request.

**DROP-IN ISOLATOR**



**Specifications**

Parameter	Minimum	Typical	Maximum
Frequency Range (MHz)	850		870
Insertion Loss (dB)		<. 17	.30
Isolation (dB)	20	>23	
Return Loss (dB)	20	>25	
IMD (dBc) 2T x 37.5 Watts	-70	-75	

**Absolute Maximum Ratings**

Parameter	Maximum
Forward Power	100 Watts
Reverse Power	30 Watts
Operating Temperature	-40 to +85 °C
Storage Temperature	-40 to +85 °C

Note: Typical values represent Mid-band performance @ 25°C.

**Schematic**

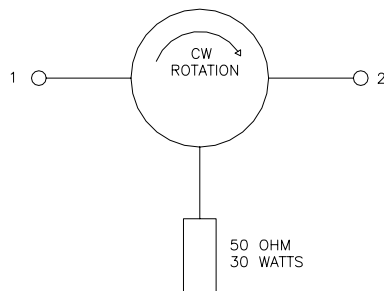

**Package**

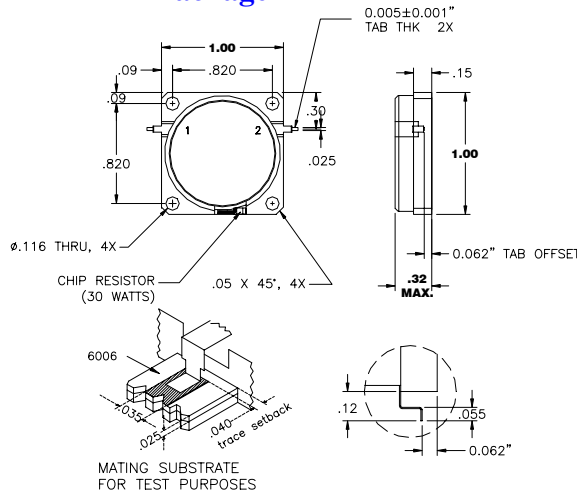

**Pin Functions**

Function	Pin
INPUT	1
OUTPUT	2

Typical Test Data – Insertion Loss



Typical Test Data – Return Loss and Isolation

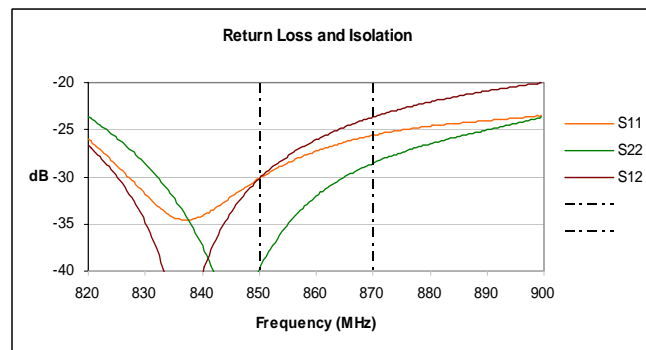

Specifications and information on this data sheet are subject to change without notice..