



Absolute Maximum Rating

Ta = 25°C

Part No.	Power Dissipation Pd	Reverse Voltage VR	Operating Temperature Topr	Storage Temperature Tstg
PP403	75	30	-30~+85	-30~+100
Units	mW	V	°C	°C

Electro-Optical Characteristics

Ta = 25°C

Part No.	Photo Current			Response Time			Capacitance ^{※1}		Dark Current		Peak Wavelength		Photo Sensitivity	
	TYP	VR	Ee	TYP	VR	RL	TYP	VR	MAX	VR	TYP	VR	TYP	VR
PP403	1.5	5	0.5	20	10	1,000	7	10	10	10	950	0	0.64	5
Units	μA	V	mW/cm ²	ns	V	Ω	pF	V	nA	V	nm	V	A/W	V

※1 f=1MHz

Package Dimensions

Unit : mm

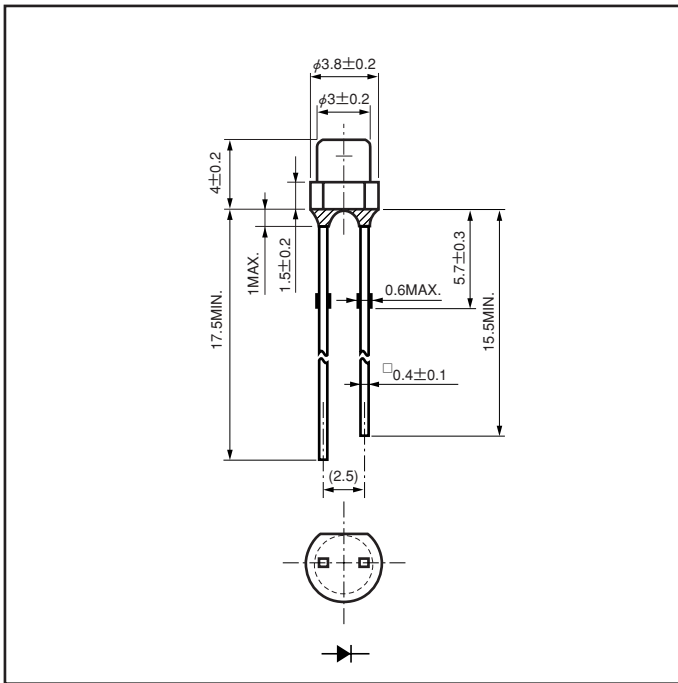

Spatial Distribution

Ta = 25°C

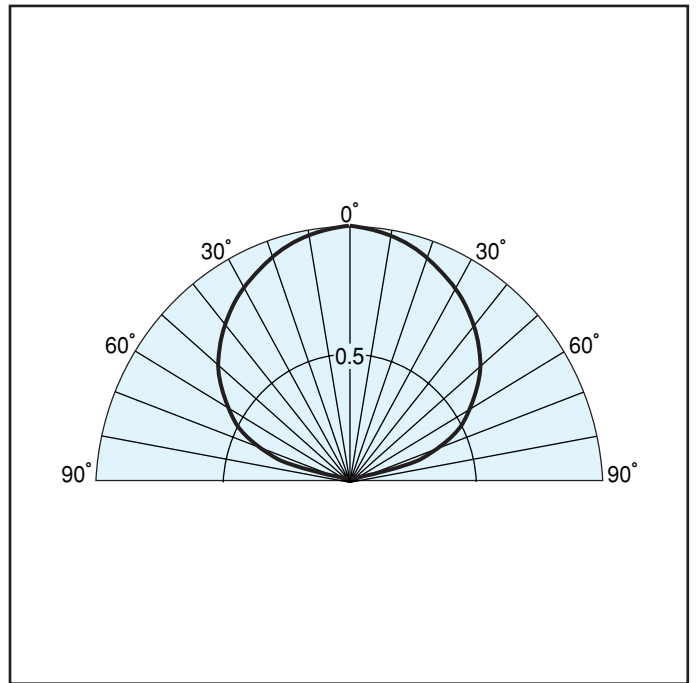

■ Radiant Illumination vs. Relative Photo Current

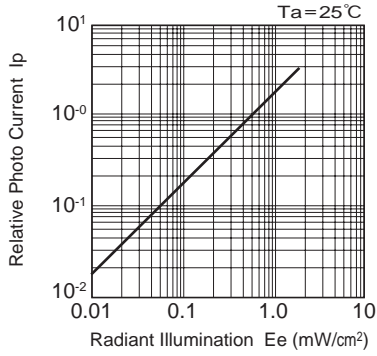

■ Reverse Voltage vs. Photo Current

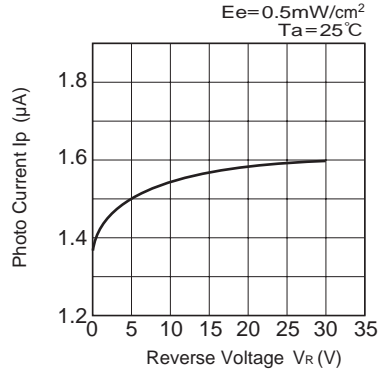

■ Reverse Voltage vs. Dark Current

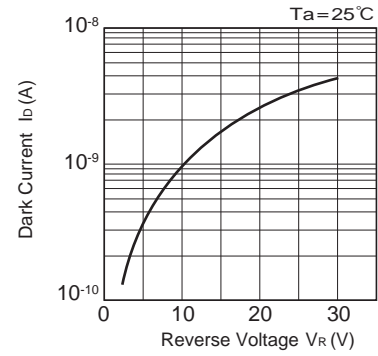

■ Ambient Temperature vs. Relative Photo Current

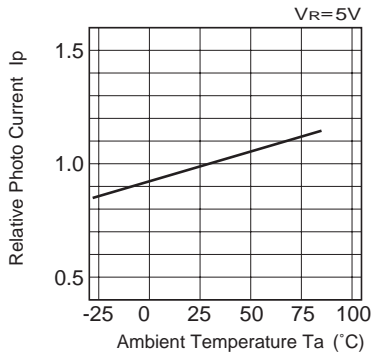

■ Ambient Temperature vs. Power Dissipation

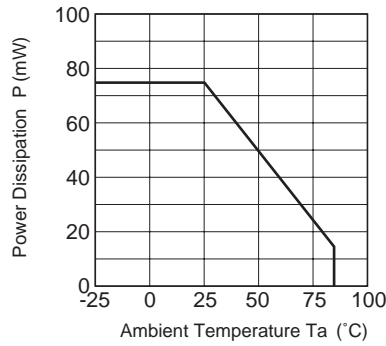

■ Ambient Temperature vs. Dark Current

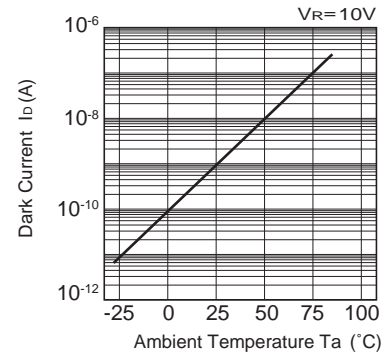

■ Spectral Sensitivity Characteristics

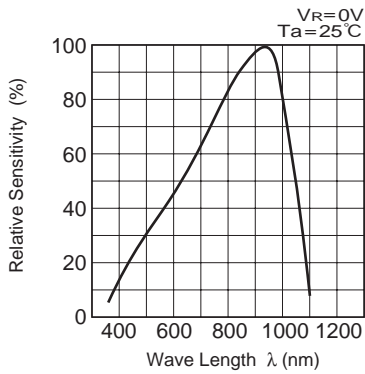

■ Reverse Voltage vs. Terminal Capacitance

