

PQ05RA1/PQ05RA11 Series

OFF-state Low Dissipation Current 1A Output, Low Power-Loss Voltage Regulators

■ Features

- Low power-loss (Dropout voltage : MAX.0.5V)
- Compact resin full-mold package
- OFF-state low dissipation current
(I_{qs} :1 μ A, 1/10⁴ as compared to former model PQ05RF1)
- Built-in ON/OFF control function

■ Applications

- Series power supplies for OA and AV equipment such as camcorders, word processors, etc.

■ Model Line-ups

Output voltage	5V Output	9V Output	12V Output
Output voltage precision:±5%	PQ05RA1	PQ09RA1	PQ12RA1
Output voltage precision:±2.5%	PQ05RA11	PQ09RA11	PQ12RA11

■ Outline Dimensions

(Unit : mm)

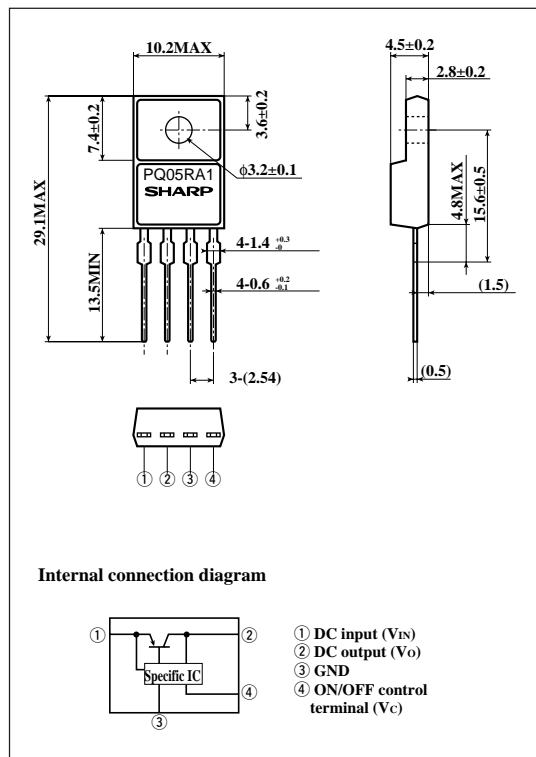

■ Absolute Maximum Ratings

($T_a=25^{\circ}\text{C}$)

Parameter	Symbol	Rating	Unit
*1 Input voltage	V_{IN}	35	V
*1 ON/OFF control terminal voltage	V_C	35	V
Output current	I_O	1	A
Power dissipation (No heat sink)	P_{D1}	1.5	W
Power dissipation (With infinite heat sink)	P_{D2}	15	W
*2 Junction temperature	T_j	150	$^{\circ}\text{C}$
Operating temperature	T_{opr}	-20 to +80	$^{\circ}\text{C}$
Storage temperature	T_{stg}	-40 to +150	$^{\circ}\text{C}$
*3 Soldering temperature	T_{sol}	260	$^{\circ}\text{C}$

*1 All are open except GND and applicable terminals.

*2 Overheat protection may operate at $125 < T_j < 150^{\circ}\text{C}$.

*3 For 10s.

· Please refer to the chapter "Handling Precautions".

SHARP

"In the absence of confirmation by device specification sheets, SHARP takes no responsibility for any defects that may occur in equipment using any SHARP devices shown in catalogs, data books, etc. Contact SHARP in order to obtain the latest version of the device specification sheets before using any SHARP's device."

■ Electrical Characteristics

(Unless otherwise specified condition shall be $I_o=0.5A$, $T_a=25^{\circ}C^{*4}$)

Parameter	Symbol	Conditions	MIN.	TYP.	MAX.	Unit
Output voltage	V_o	-	4.75	5.0	5.25	V
			8.55	9.0	9.45	
			11.4	12.0	12.6	
			4.88	5.0	5.12	
			8.78	9.0	9.22	
			11.7	12.0	12.3	
Load regulation	R_{egL}	$I_o=5mA$ to 1.0A	-	0.1	2.0	%
Line regulation	R_{egI}	*5	-	0.2	2.5	%
Temperature coefficient of output voltage	T_cV_o	$T_j=0$ to $125^{\circ}C$	-	± 0.004	-	%/ $^{\circ}C$
Ripple rejection	RR	Refer to Fig.2	45	55	-	dB
Dropout voltage	V_{i-o}	*6	-	-	0.5	V
ON-state voltage for control	$V_C(ON)$	-	2.0	-	-	V
ON-state current for control	$I_C(ON)$	-	-	-	200	μA
*7 OFF-state voltage for control	$V_C(OFF)$	-	-	-	0.8	V
OFF-state current for control	$I_C(OFF)$	$V_C=0.4V$	-	-	2	μA
Quiescent current	I_q	$I_o=0A, V_{IN}=35V$	-	-	8	mA
Output OFF-state consumption current	I_{qs}	$I_o=0A, V_{IN}=35V$ $V_C=0.4V$	-	-	1	μA

*4 PQ05RA1 series: $V_{IN}=7V$, PQ09RA1 series: $V_{IN}=11V$, PQ12RA1 series: $V_{IN}=14V$

*5 PQ05RA1/PQ05RA11: $V_{IN}=6$ to 16V
PQ09RA1/PQ09RA11: $V_{IN}=10$ to 20V
PQ12RA1/PQ12RA11: $V_{IN}=13$ to 23V

*6 Input voltage shall be the value when output voltage is 95% in comparison with the initial value.

*7 In case of opening control terminal ④, output voltage turns off.

Fig.1 Test Circuit

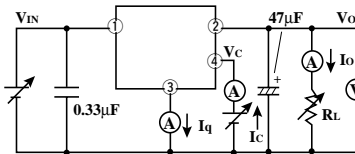

Fig.2 Test Circuit of Ripple Rejection

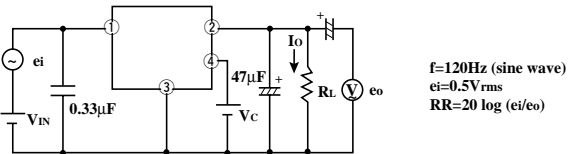
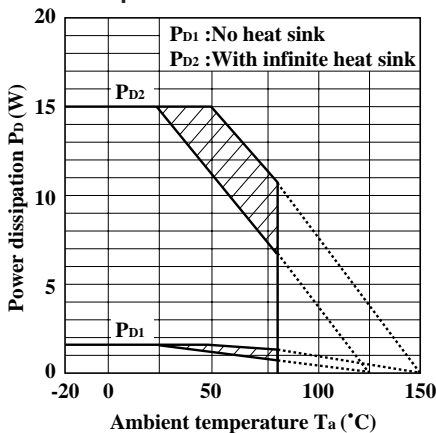

Fig.3 Power Dissipation vs. Ambient Temperature



Note) Oblique line portion:Overheat protection may operate in this area

Fig.4 Overcurrent Protection Characteristics (Typical value)

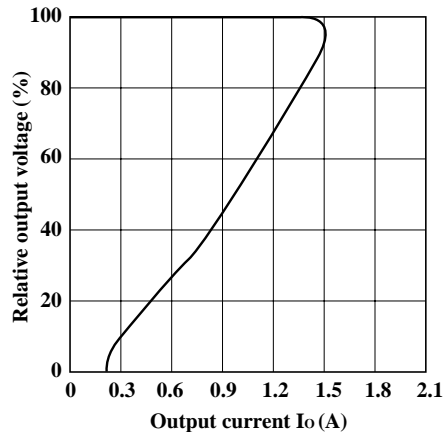

Fig.5 Output Voltage Deviation vs. Junction Temperature (PQ05RA1/11)

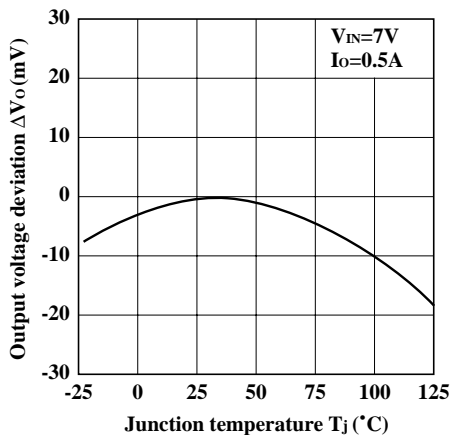

Fig.6 Output Voltage Deviation vs. Junction Temperature (PQ09RA1/11)

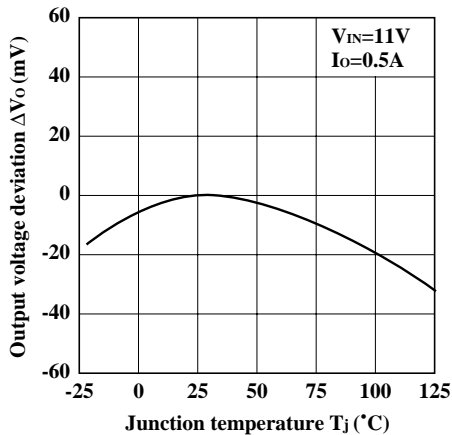

Fig.7 Output Voltage Deviation vs. Junction Temperature (PQ12RA1/11)

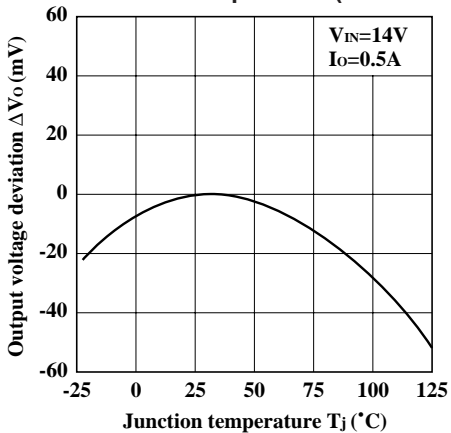

Fig.8 Output Voltage vs. Input Voltage (PQ05RA1/11)

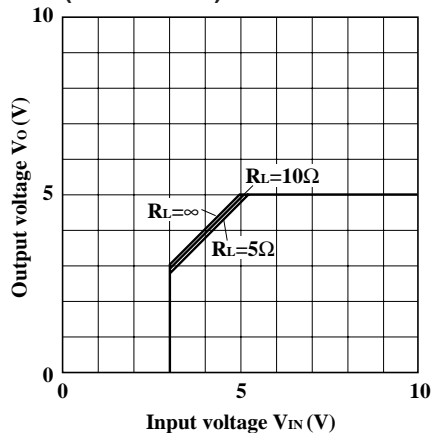

Fig.9 Output Voltage vs. Input Voltage (PQ09RA1/11)

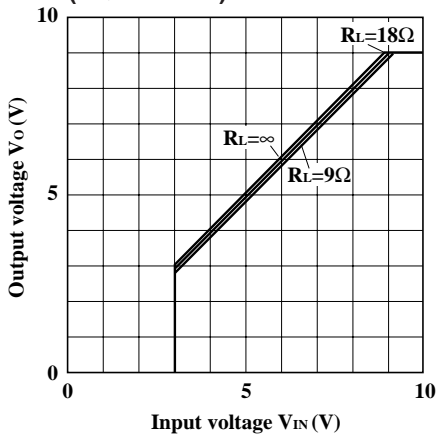

Fig.10 Output Voltage vs. Input Voltage (PQ12RA1/11)

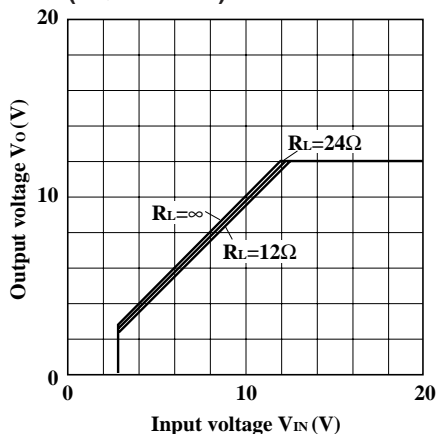

Fig.11 Circuit Operating Current vs. Input Voltage (PQ05RA1/11)

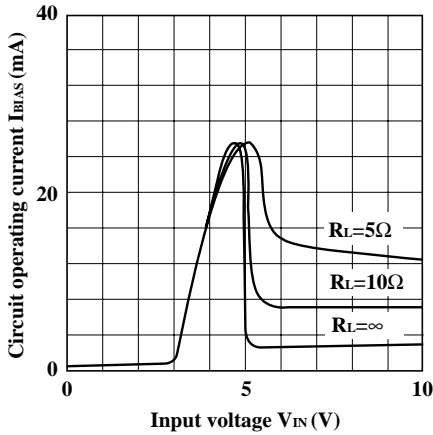

Fig.12 Circuit Operating Current vs. Input Voltage (PQ09RA1/11)

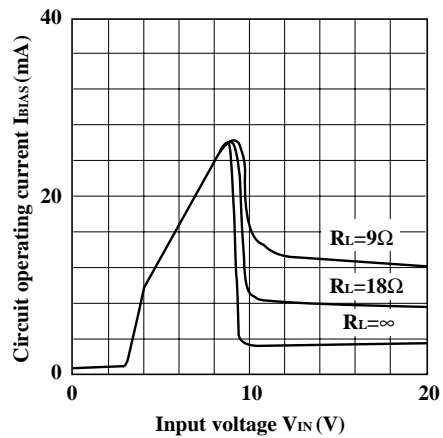

Fig.13 Circuit Operating Current vs. Input Voltage (PQ12RA1/11)

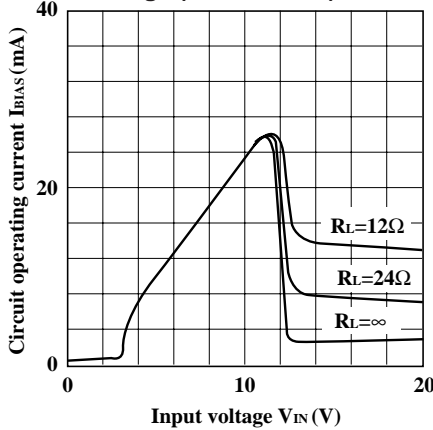

Fig.14 Dropout Voltage vs. Junction Temperature

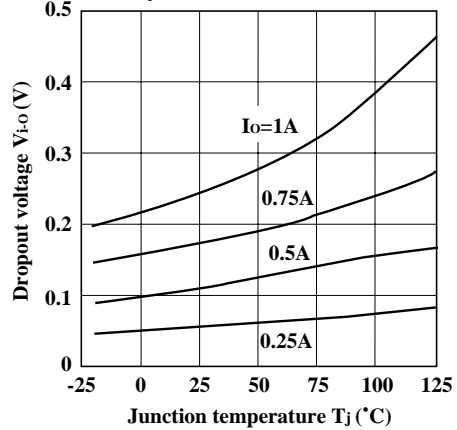

Fig.15 Quiescent Current vs. Junction Temperature

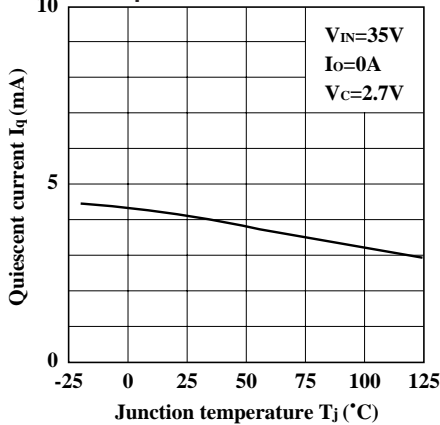

Fig.16 Ripple Rejection vs. Input Ripple Frequency

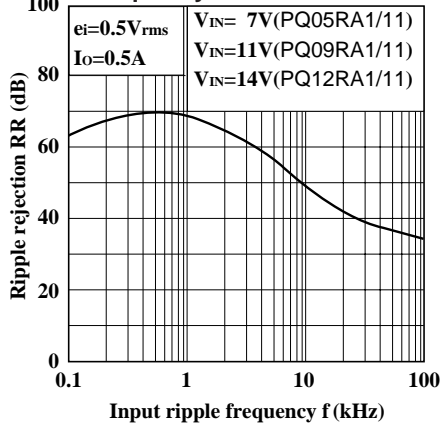

Fig.17 Ripple Rejection vs. Output Current

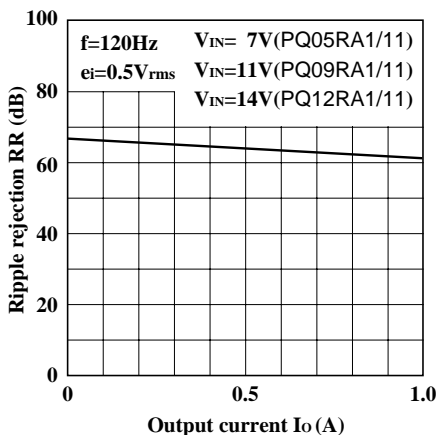

Fig.18 Output Peak Current vs. Junction Temperature

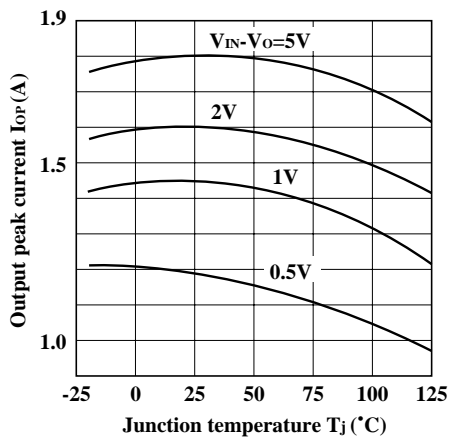
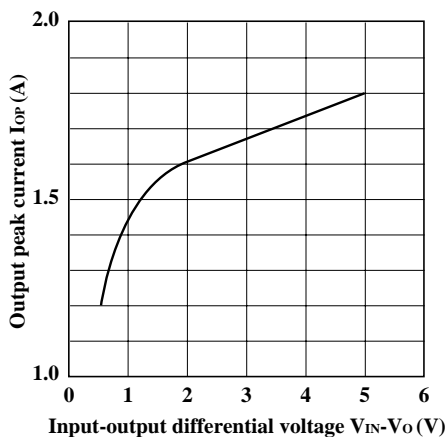

Fig.19 Output Peak Current vs. Input-output Differential Voltage



■ Typical Application

