

# PQ05RF2/21/2V Series

2A Output, Low Power-Loss Voltage Regulators

## ■ Features

- Low power-loss (Dropout voltage: MAX. 0.5V)
- Compact resin full-mold package.
- Built-in ON/OFF control terminal (PQ05RF2/PQ05RF21 series)
- Built-in output voltage minute adjustment terminal (ripple rejection is improved) (PQ05RF2V series)

## ■ Model Line-ups

Output voltage	5V Output	9V Output	12V Output	15V Output
Output voltage precision:±5%	PQ05RF2	PQ09RF2	PQ12RF2	PQ15RF2
Output voltage precision:±2.5%	PQ05RF21	PQ09RF21	PQ12RF21	PQ15RF21
Minute adjustment (Output voltage adjustment range:±10%)	PQ05RF2V	PQ09RF2V	PQ12RF2V	PQ15RF2V

## ■ Applications

- Series power supply for various electronic equipment such as VCRs, electronic music instruments

## ■ Equivalent Circuit Diagram

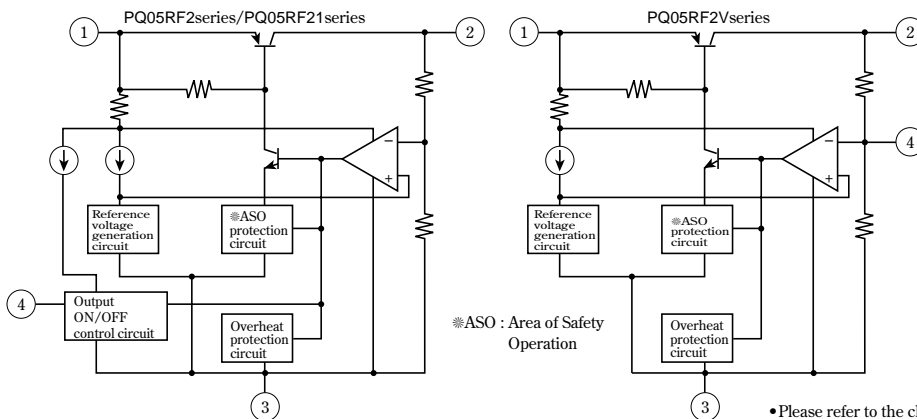

## ■ Outline Dimensions

(Unit : mm)

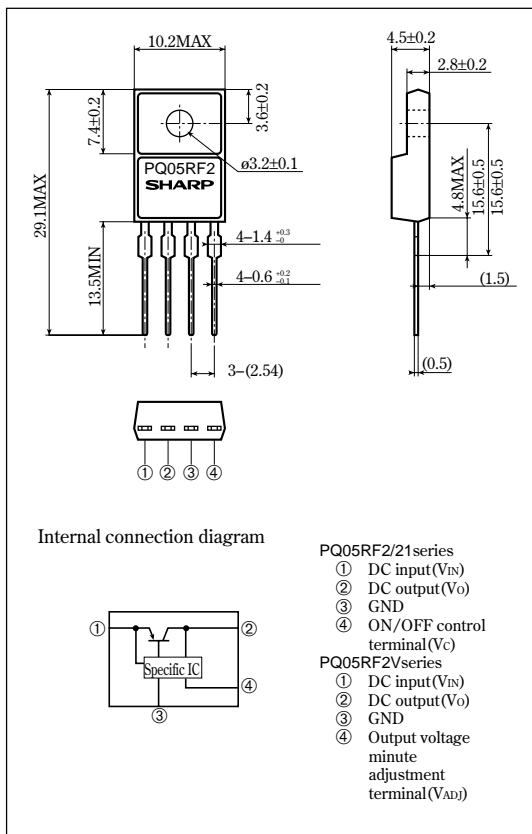

• Please refer to the chapter " Handling Precautions ".



**Absolute Maximum Ratings**

(T<sub>a</sub>=25°C)

Parameter		Symbol	Rating	Unit
*1	Input voltage	V <sub>IN</sub>	35	V
*1	ON/OFF control terminal voltage	PQ05RF2 series	35	V
		PQ05RF21 series		
	Output current	I <sub>o</sub>	2	A
	Power dissipation (No heat sink)	P <sub>D1</sub>	1.5	W
	Power dissipation (With infinite heat sink)	P <sub>D2</sub>	18	W
*2	Junction temperature	T <sub>j</sub>	150	°C
	Operating temperature	T <sub>opr</sub>	-20 to +80	°C
	Storage temperature	T <sub>stg</sub>	-40 to +150	°C
	Soldering temperature	T <sub>sol</sub>	260 (For 10s)	°C

\*1 All are open except GND and applicable terminals.

\*2 Overheat protection may operate at 125<=T<sub>j</sub><=150°C.

**Electrical Characteristics**

(Unless otherwise specified, condition shall be I<sub>o</sub>=1A, T<sub>a</sub>=25°C, \*3)

Parameter		Symbol	Conditions	MIN.	TYP.	MAX.	Unit
Output voltage	PQ05RF2/PQ05RF2V	V <sub>o</sub>	-	4.75	5.0	5.25	V
	PQ09RF2/PQ09RF2V			8.55	9.0	9.45	
	PQ12RF2/PQ12RF2V			11.4	12.0	12.6	
	PQ15RF2/PQ15RF2V			14.25	15.0	15.75	
	PQ05RF21			4.88	5.0	5.12	
	PQ09RF21			8.78	9.0	9.22	
	PQ12RF21			11.7	12.0	12.3	
	PQ15RF21			14.63	15.0	15.37	
Load regulation	R <sub>egL</sub>	I <sub>o</sub> =5mA to 2A	-	0.5	2.0	%	
Line regulation	R <sub>egI</sub>	*4	-	0.5	2.5	%	
Temperature coefficient of output voltage	TcV <sub>o</sub>	T <sub>j</sub> =0 to 125°C	-	±0.02	-	%/°C	
Ripple rejection	PQ05RF2/PQ05RF21Series	RR	I <sub>o</sub> =0.5A Refer to Fig.2	45	55	-	dB
	PQ05RF2VSeries			55	-	-	
Dropout voltage	V <sub>f-o</sub>	*5, I <sub>o</sub> =2A	-	-	0.5	V	
ON-state voltage for control	PQ05RF2/PQ05RF21Series	V <sub>c</sub> (ON)	-	2.0 *6	-	V	
ON-state current for current	PQ05RF2/PQ05RF21Series	I <sub>c</sub> (ON)	V <sub>c</sub> =2.7V	-	-	20	µA
OFF-state voltage for control	PQ05RF2/PQ05RF21Series	V <sub>c</sub> (OFF)	-	-	0.8	V	
OFF-state current for control	PQ05RF2/PQ05RF21Series	I <sub>c</sub> (OFF)	V <sub>c</sub> =0.4V	-	-	-0.4	mA
Quiescent current	I <sub>q</sub>	I <sub>o</sub> =0	-	-	10	mA	
Output voltage minute adjustment range	PQ05RF2V	V <sub>o</sub> (ADJ)	-	4.5	5.0	5.5	V
	PQ09RF2V			8.1	9.0	9.9	
	PQ12RF2V			10.8	12.0	13.2	
	PQ15RF2V			13.5	15.0	16.5	

\*3 PQ05RF2 Series: V<sub>IN</sub>=7V, PQ09RF2 Series: V<sub>IN</sub>=15V, PQ12RF2 Series: V<sub>IN</sub>=18V, PQ15RF2 Series: V<sub>IN</sub>=23V

\*4 PQ05RF2/PQ05RF21/PQ05RF2V: V<sub>IN</sub>=6 to 12V PQ09RF2/PQ09RF21/PQ09RF2V: V<sub>IN</sub>=10 to 25V

PQ12RF2/PQ12RF21/PQ12RF2V: V<sub>IN</sub>=13 to 29V PQ15RF2/PQ15RF21/PQ15RF2V: V<sub>IN</sub>=16 to 32V

\*5 Input voltage shall be the value when output voltage is 95% in comparison with the initial value.

\*6 In case of opening control terminal @, output voltage turns on. (PQ05RF2/PQ05RF21 Series)

Fig. 1 Test Circuit

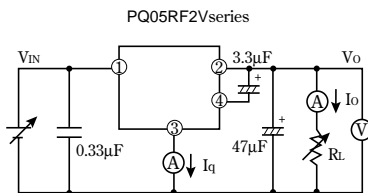
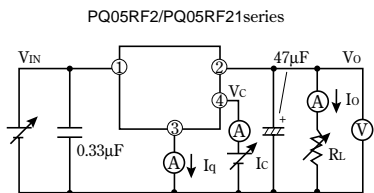

Fig. 2 Test Circuit of Ripple Rejection

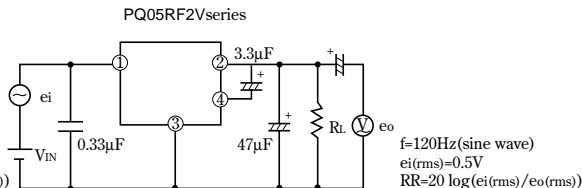
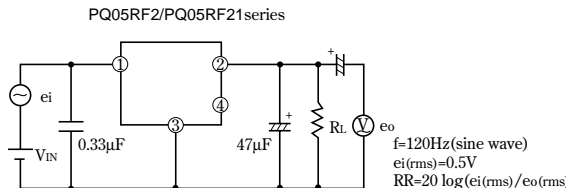
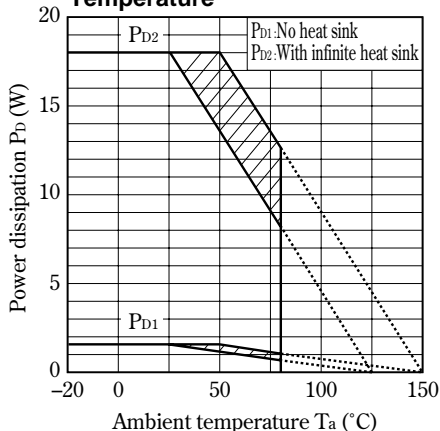

Fig. 3 Power Dissipation vs. Ambient Temperature



Note) Oblique line portion : Overheat protection may operate in this area.

Fig. 4 Overcurrent Protection Characteristics (Typical value)

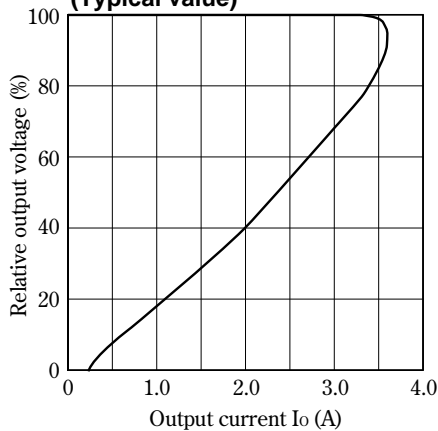

Fig. 5 Output Voltage Minute Adjustment Characteristics (PQ05RF2V)

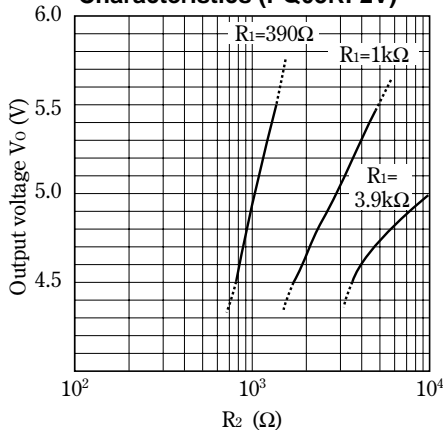
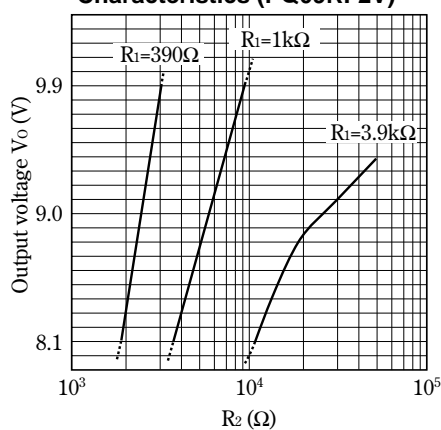
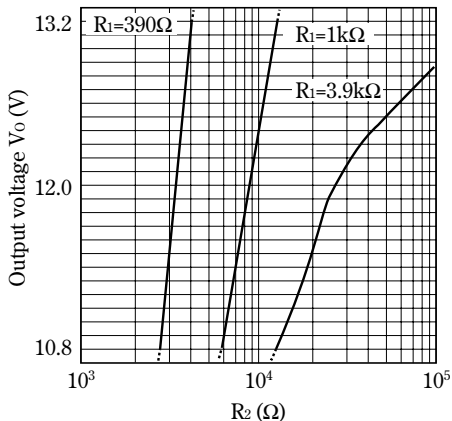

Fig. 6 Output Voltage Minute Adjustment Characteristics (PQ09RF2V)



**Fig. 7 Output Voltage Minute Adjustment Characteristics (PQ12RF2V)**



**Fig. 8 Output Voltage Minute Adjustment Characteristics (PQ15RF2V)**

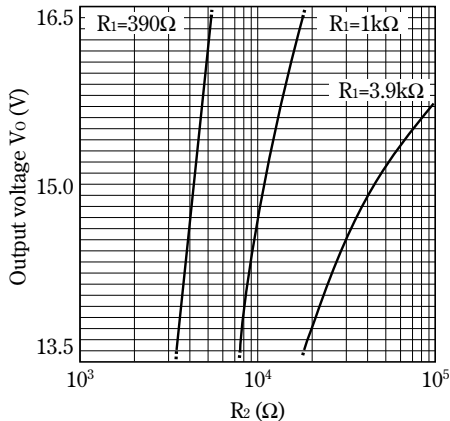

**Fig. 9 Output Voltage Deviation vs. Junction Temperature (PQ05RF2/PQ05RF21/PQ05RF2V)**

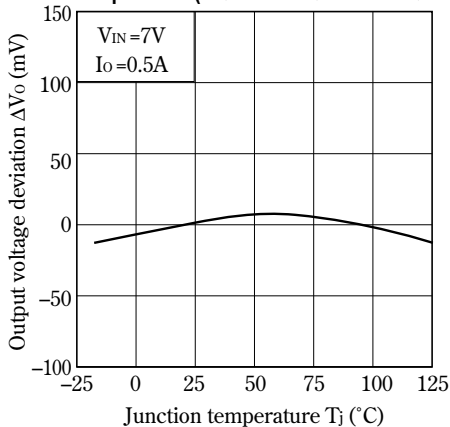

**Fig.10 Output Voltage Deviation vs. Junction Temperature (PQ09RF2/PQ09RF21/PQ09RF2V)**

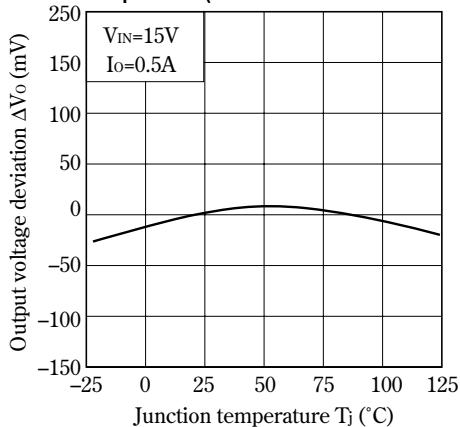

**Fig.11 Output Voltage Deviation vs. Junction Temperature (PQ12RF2/PQ12RF21/PQ12RF2V)**

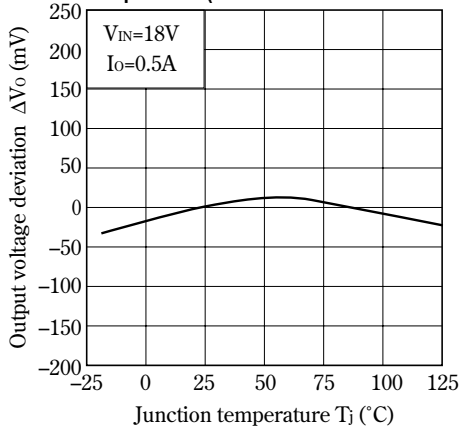

**Fig.12 Output Voltage Deviation vs. Junction Temperature (PQ15RF2/PQ15RF21/PQ15RF2V)**

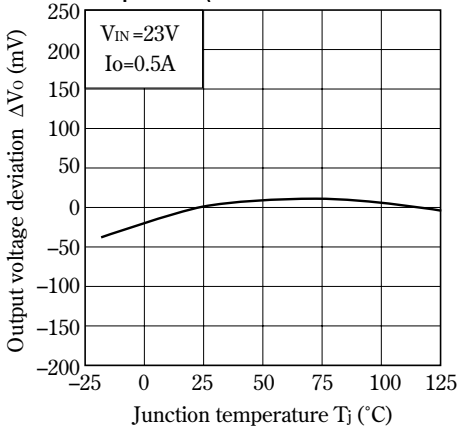

**Fig.13 Output Voltage vs. Input Voltage (PQ05RF2/PQ05RF21/PQ05RF2V)**

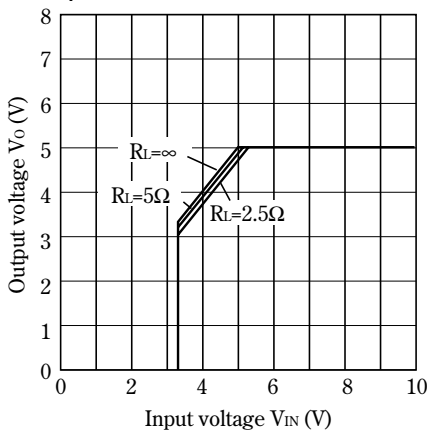

**Fig.14 Output Voltage vs. Input Voltage (PQ09RF2/PQ09RF21/PQ09RF2V)**

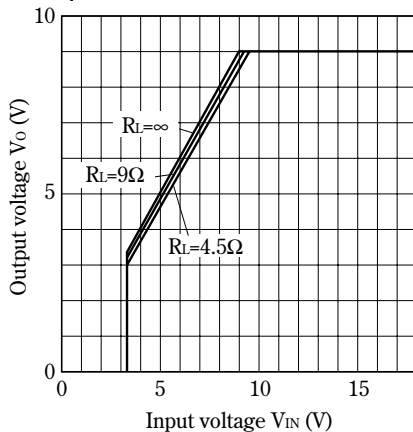

**Fig.15 Output Voltage vs. Input Voltage (PQ12RF2/PQ12RF21/PQ12RF2V)**

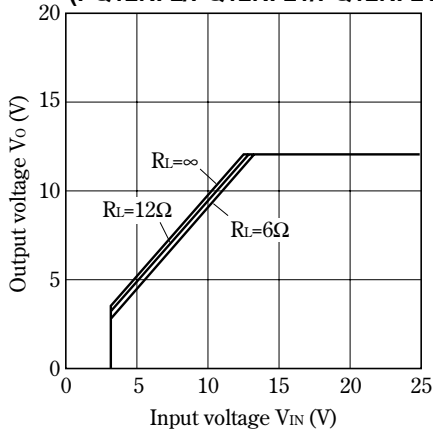

**Fig.16 Output Voltage vs. Input Voltage (PQ15RF2/PQ15RF21/PQ15RF2V)**

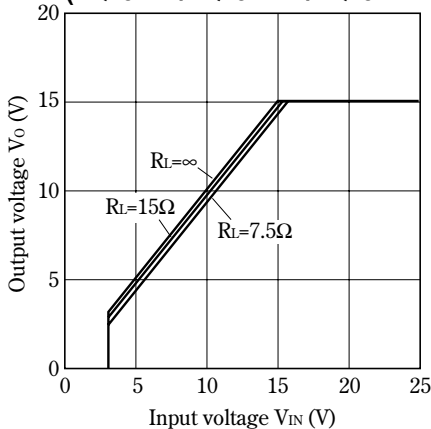

**Fig.17 Circuit Operating Current vs. Input Voltage (PQ05RF2/PQ05RF21/PQ05RF2V)**

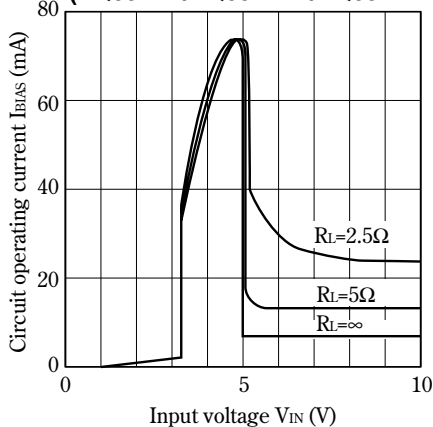

**Fig.18 Circuit Operating Current vs. Input Voltage (PQ09RF2/PQ09RF21/PQ09RF2V)**

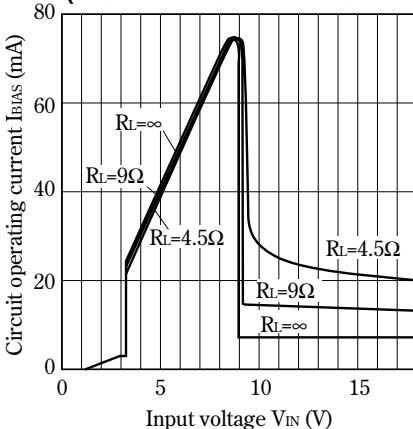

**Fig.19 Circuit Operating Current vs. Input Voltage (PQ12RF2/PQ12RF21/PQ12RF2V)**

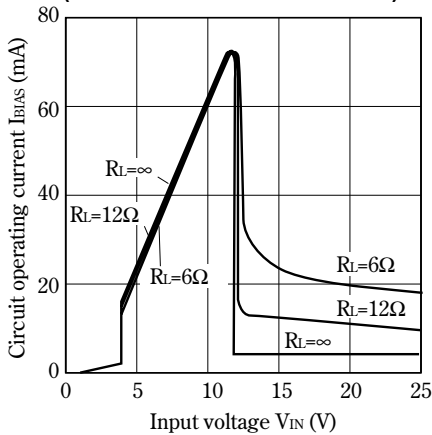

**Fig.20 Circuit Operating Current vs. Input Voltage (PQ15RF2/PQ15RF21/PQ15RF2V)**

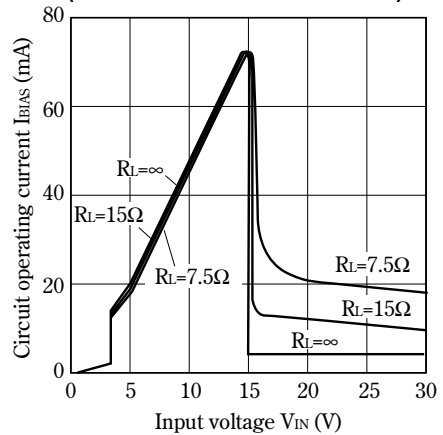

**Fig.21 Dropout Voltage vs. Junction Temperature**

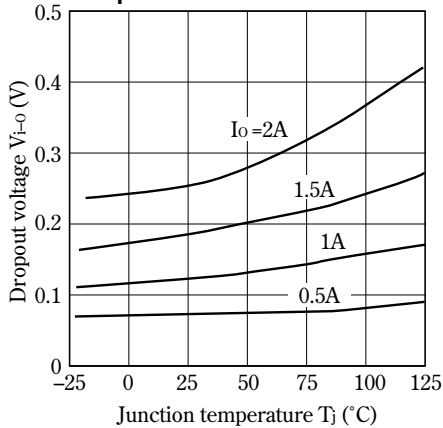

**Fig.22 Quiescent Current vs. Junction Temperature**

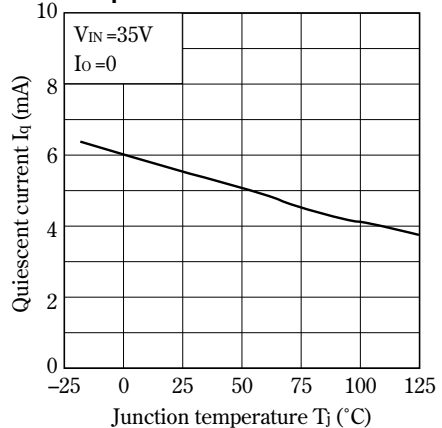

**Fig.23 Ripple Rejection vs. Input Ripple Frequency (PQ05RF2/PQ05RF21/PQ09RF2/PQ09RF21/PQ12RF2/PQ12RF21/PQ15RF2/PQ15RF21)**

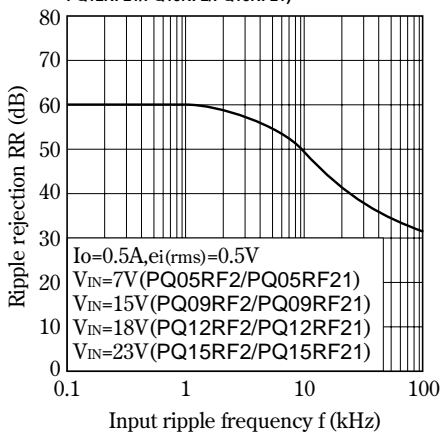

**Fig.24 Ripple Rejection vs. Input Ripple Frequency (PQ05RF2V/PQ09RF2V/PQ12RF2V/PQ15RF2V)**

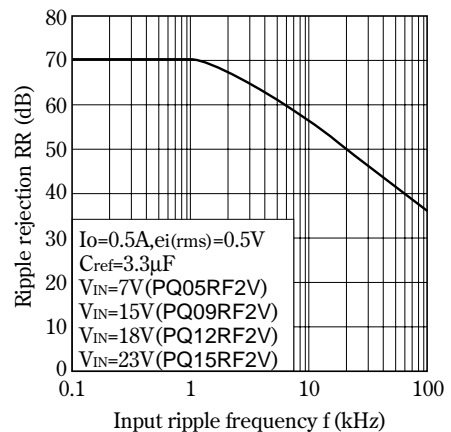
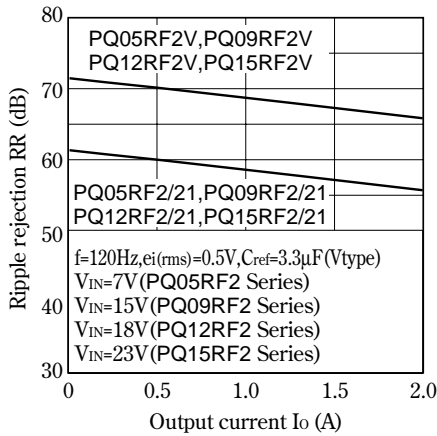
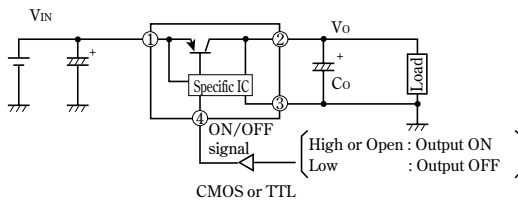

Fig.25 Ripple Rejection vs. Output Current



■ Typical Application

PQ05RF2/PQ05RF21 Series



PQ05RF2V Series

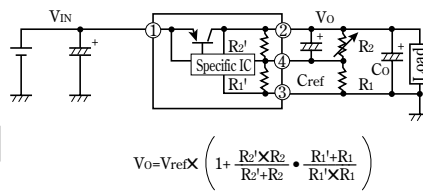

$V_{\text{ref}}$  Nearly=1.26V,  $R_1'$  Nearly=390Ω  
 PQ05RF2V :  $R_2'$  Nearly=1.16kΩ  
 PQ09RF2V :  $R_2'$  Nearly=2.40kΩ  
 PQ12RF2V :  $R_2'$  Nearly=3.32kΩ  
 PQ15RF2V :  $R_2'$  Nearly=4.45kΩ

(Note)  $R_1'$  and  $R_2'$  are built in a specific IC.

■ Model Line-ups for Lead Forming Type

Output voltage	5V Output	9V Output	12V Output	15V Output
Output voltage precision:±5%	PQ05RF2A	PQ09RF2A	PQ12RF2A	PQ15RF2A
Output voltage precision:±2.5%	PQ05RF2B	PQ09RF2B	PQ12RF2B	PQ15RF2B

Outline Dimensions (PQ05RF2A/PQ05RF2B Series)

(Unit : mm)

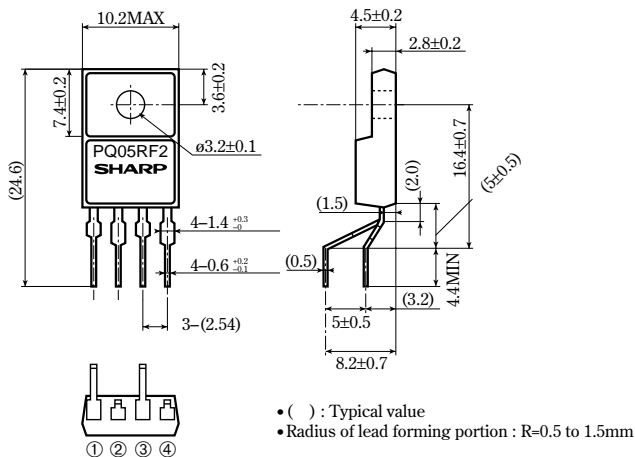

Internal connection diagram

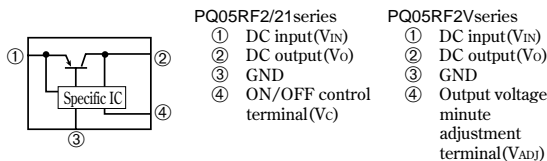

Note) The value of absolute maximum ratings and electrical characteristics is same as ones of PQ05RF2/21series.

Precautions for Use

(1) Minute adjustment of output voltage (PQ05RF2V series)

If the external resistor is attached to the terminals ②, ③ and ④, minute adjustment of output voltage is possible. (Refer to the example of basic circuit (PQ05RF2V series) and Fig.5 to 8.)