

Features

- Glass Passivated Die Construction
- Fast Switching for High Efficiency
- Surge Overload Rating to 80A Peak
- Low Reverse Leakage Current
- Lead Free Finish, RoHS Compliant (Note 4)**

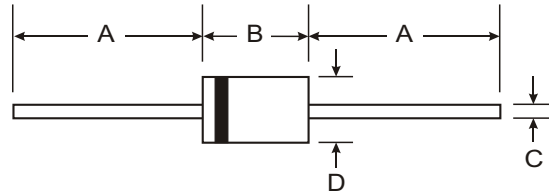

Mechanical Data

- Case: DO-15
- Case Material: Molded Plastic. UL Flammability Classification Rating 94V-0
- Moisture Sensitivity: Level 1 per J-STD-020C
- Terminals: Finish – Tin. Solderable per MIL-STD-202, Method 208
- Polarity: Cathode Band
- Marking: Type Number
- Ordering Information: See Page 3
- Weight: 0.4 grams (approximate)

DO-15		
Dim	Min	Max
A	25.40	
B	5.50	7.62
C	0.686	0.889
D	2.60	3.60
All Dimensions in mm		

Maximum Ratings and Electrical Characteristics @ T_A = 25 °C unless otherwise specified

Single phase, half wave, 60Hz, resistive or inductive load.
For capacitive load, derate current by 20%.

Characteristic	Symbol	PR 2001G	PR 2002G	PR 2003G	PR 2004G	PR 2005G	PR 2006G	PR 2007G	Unit
Peak Repetitive Reverse Voltage Working Peak Reverse Voltage DC Blocking Voltage (Note 5)	V _{RRM} V _{RWM} V _R	50	100	200	400	600	800	1000	V
RMS Reverse Voltage	V _{R(RMS)}	35	70	140	280	420	560	700	V
Average Rectified Output Current (Note 1) @ T _A = 55 °C	I _O	2.0							A
Non-Repetitive Peak Forward Surge Current 8.3ms Single half sine-wave Superimposed on Rated Load	I _{FSM}	80							A
Forward Voltage Drop @ I _F = 2.0A	V _{FM}	1.3							V
Peak Reverse Current at Rated DC Blocking Voltage (Note 5) @ T _A = 25 °C @ T _A = 100 °C	I _{RM}	5.0 100							A
Reverse Recovery Time (Note 3)	t _{rr}	150				250	500		ns
Typical Total Capacitance (Note 2)	C _T	35							pF
Typical Thermal Resistance Junction to Ambient	R _{JA}	50							°C/W
Operating and Storage Temperature Range	T _j , T _{STG}	-65 to +150							°C

- Notes:
1. Valid provided that leads are maintained at ambient temperature at a distance of 9.5mm from the case.
 2. Measured at 1.0MHz and applied reverse voltage of 4.0V DC.
 3. Measured with I_F = 0.5A, I_R = 1.0A, I_{rr} = 0.25A. See figure 5.
 4. RoHS revision 13.2.2003. Glass and high temperature solder exemptions applied, see *EU Directive Annex Notes 5 and 7*.
 5. Short duration pulse test used to minimize self-heating effect.

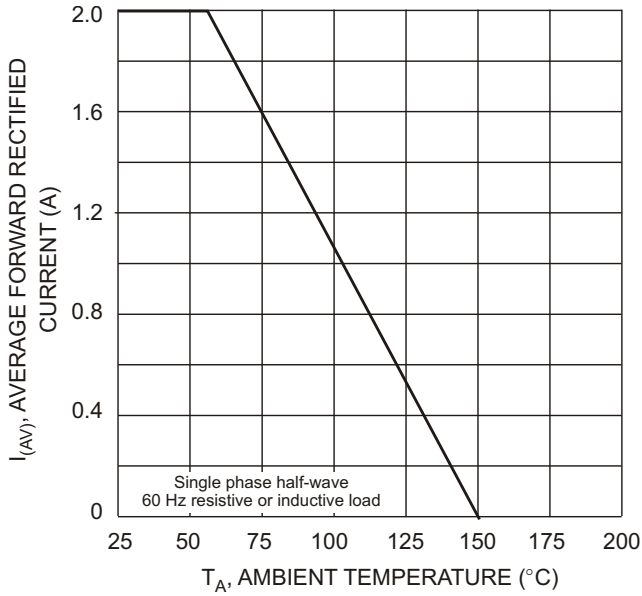

Fig. 1 Forward Derating Curve

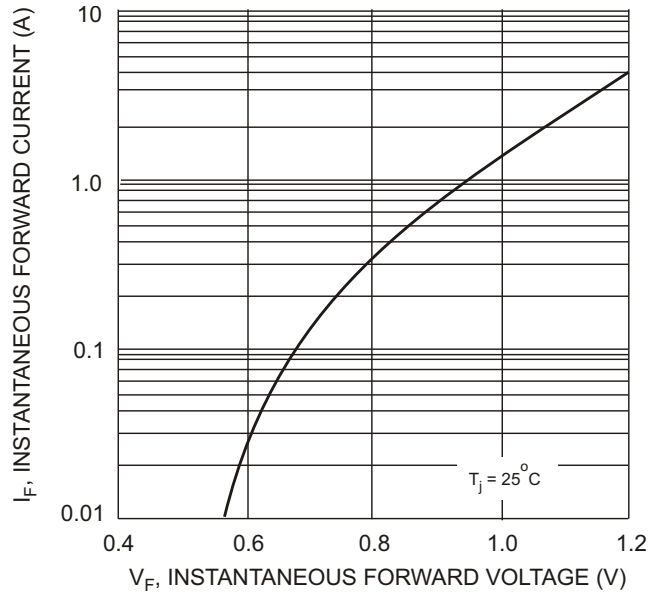

Fig. 2 Typical Forward Characteristics

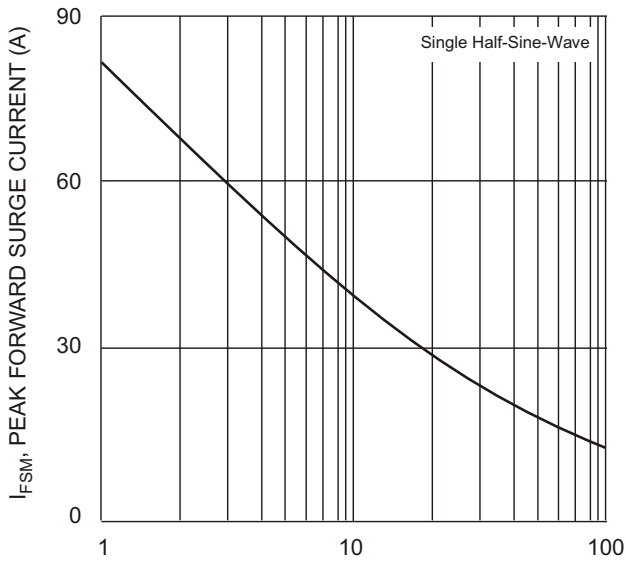

Fig. 3 Peak Forward Surge Current

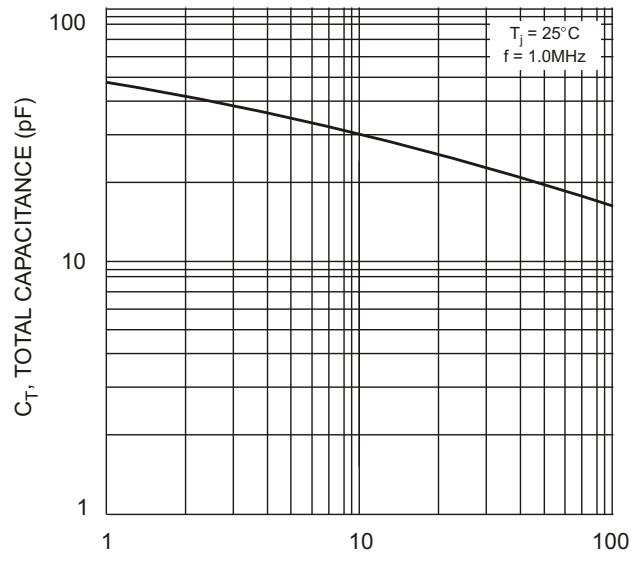
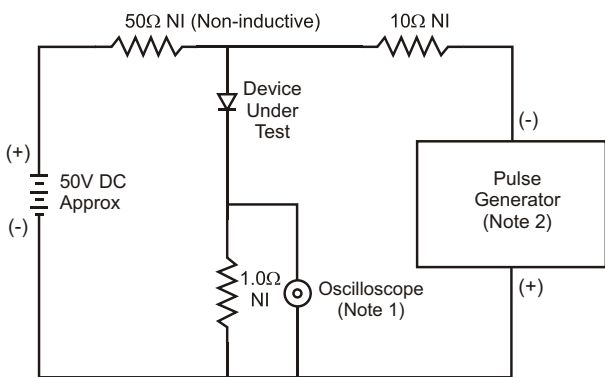
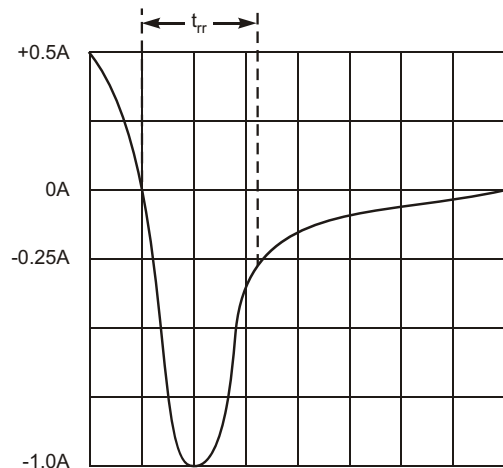

Fig. 4 Typical Total Capacitance



- Notes:
 1. Rise Time = 7.0ns max. Input Impedance = 1.0MΩ, 22pF.
 2. Rise Time = 10ns max. Input Impedance = 50Ω.



Set time base for 50/100 ns/cm

Fig. 5 Reverse Recovery Time Characteristic and Test Circuit

Ordering Information (Note 6)

Device	Packaging	Shipping
PR2001G-T	DO-15	4K/Tape & Reel, 13-inch
PR2002G-T	DO-15	4K/Tape & Reel, 13-inch
PR2003G-T	DO-15	4K/Tape & Reel, 13-inch
PR2004G-T	DO-15	4K/Tape & Reel, 13-inch
PR2005G-T	DO-15	4K/Tape & Reel, 13-inch
PR2006G-T	DO-15	4K/Tape & Reel, 13-inch
PR2007G-T	DO-15	4K/Tape & Reel, 13-inch

Notes: 6. For packaging details, visit our website at <http://www.diodes.com/datasheets/ap02008.pdf>.

IMPORTANT NOTICE

Diodes Incorporated and its subsidiaries reserve the right to make modifications, enhancements, improvements, corrections or other changes without further notice to any product herein. Diodes Incorporated does not assume any liability arising out of the application or use of any product described herein; neither does it convey any license under its patent rights, nor the rights of others. The user of products in such applications shall assume all risks of such use and will agree to hold Diodes Incorporated and all the companies whose products are represented on our website, harmless against all damages.

LIFE SUPPORT

Diodes Incorporated products are not authorized for use as critical components in life support devices or systems without the expressed written approval of the President of Diodes Incorporated.