



PHOTOCOUPLER PS2801A-1, PS2801A-4

HIGH ISOLATION VOLTAGE SSOP PHOTOCOUPLER

–NEPOC Series–

DESCRIPTION

The PS2801A-1 and PS2801A-4 are optically coupled isolators containing a GaAs light emitting diode and an NPN silicon phototransistor in a plastic SSOP for high density applications to realize an excellent cost performance.

This package has shield effect to cut off ambient light.

FEATURES

- High isolation voltage (BV = 2 500 Vr.m.s.)
- Small and thin package (4, 16-pin SSOP, Pin pitch 1.27 mm)
- Ordering number of tape product: PS2801A-1-F3, F4, PS2801A-4-F3, F4
- ★ • Pb-Free product
- Safety standards
 - UL approved: File No. E72422
 - DIN EN60747-5-2 (VDE0884 Part2) approved (Option)

APPLICATIONS

- Programmable logic controllers
- Measuring instruments
- Power supply
- Hybrid IC

PIN CONNECTION (Top View)

PS2801A-1

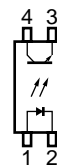

1. Anode
2. Cathode
3. Emitter
4. Collector

PS2801A-4

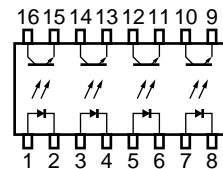

1. 3. 5. 7. Anode
2. 4. 6. 8. Cathode
9. 11. 13. 15. Emitter
10. 12. 14. 16. Collector

The information in this document is subject to change without notice. Before using this document, please confirm that this is the latest version.

PACKAGE DIMENSIONS (UNIT: mm)

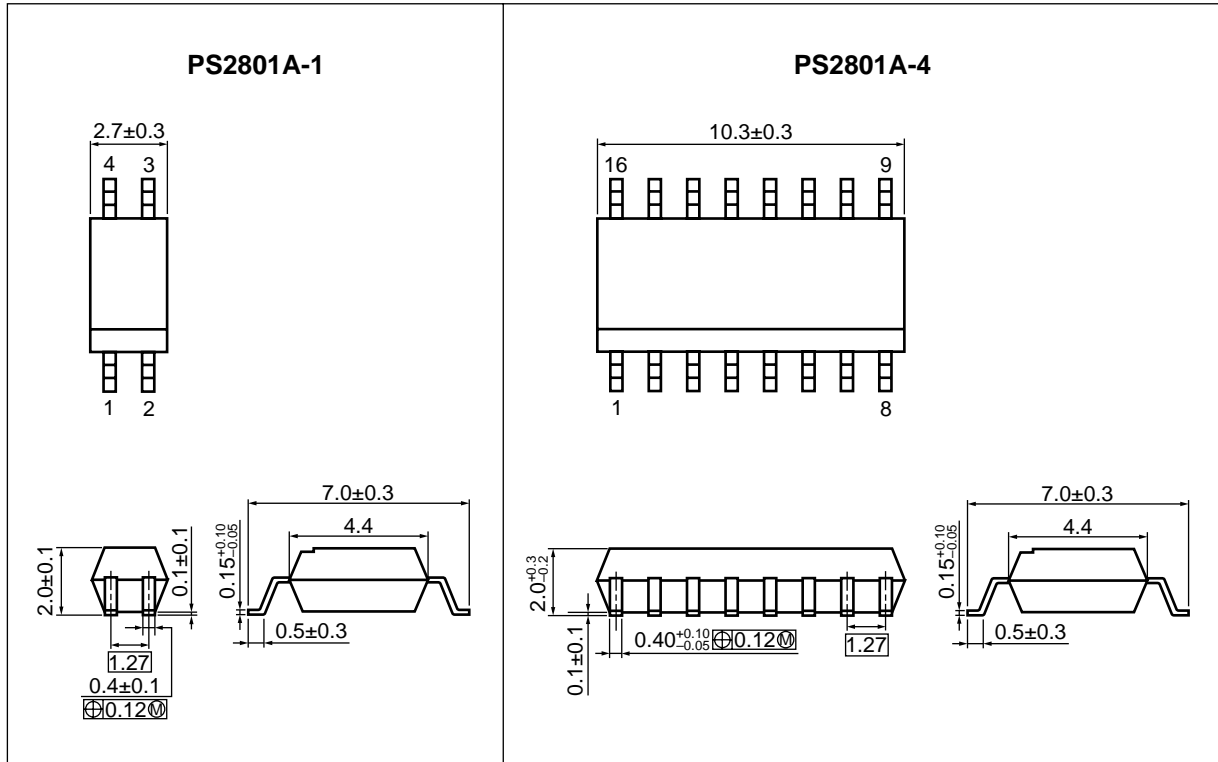

MARKING EXAMPLE

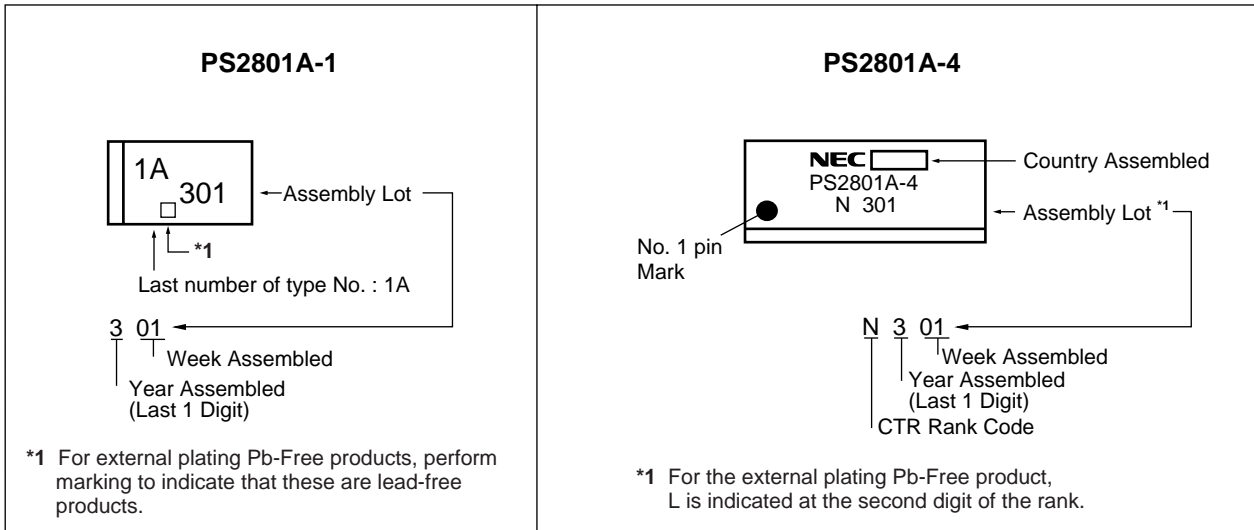

★ **ORDERING INFORMATION**

Part Number	Order Number	Solder Plating Specification	Packing Style	Safety Standard Approval	Application Part Number ^{*1}	
PS2801A-1	PS2801A-1	Solder contains lead	50 pcs (Tape 50 pcs cut)	Standard products (UL approved)	PS2801A-1	
PS2801A-1-F3	PS2801A-1-F3		Embossed Tape 3 500 pcs/reel		DIN EN60747-5-2 (VDE0884 Part2) Approved (Option)	PS2801A-4
PS2801A-1-F4	PS2801A-1-F4		Magazine Case 45 pcs			
PS2801A-4	PS2801A-4		Embossed Tape 2 500 pcs/reel			
PS2801A-4-F3	PS2801A-4-F3		50 pcs (Tape 50 pcs cut)			
PS2801A-4-F4	PS2801A-4-F4		Embossed Tape 3 500 pcs/reel			
PS2801A-1-V	PS2801A-1-V		Magazine Case 45 pcs	PS2801A-1		
PS2801A-1-V-F3	PS2801A-1-V-F3		Embossed Tape 2 500 pcs/reel			
PS2801A-1-V-F4	PS2801A-1-V-F4		50 pcs (Tape 50 pcs cut)			
PS2801A-4-V	PS2801A-4-V		Embossed Tape 3 500 pcs/reel			
PS2801A-4-V-F3	PS2801A-4-V-F3		Magazine Case 45 pcs			
PS2801A-4-V-F4	PS2801A-4-V-F4		Embossed Tape 2 500 pcs/reel			
PS2801A-1	PS2801A-1-A	Pb-Free	50 pcs (Tape 50 pcs cut)	Standard products (UL approved)	PS2801A-1	
PS2801A-1-F3	PS2801A-1-F3-A		Embossed Tape 3 500 pcs/reel		DIN EN60747-5-2 (VDE0884 Part2) Approved (Option)	PS2801A-4
PS2801A-1-F4	PS2801A-1-F4-A		Magazine Case 45 pcs			
PS2801A-4	PS2801A-4-A		Embossed Tape 2 500 pcs/reel			
PS2801A-4-F3	PS2801A-4-F3-A		50 pcs (Tape 50 pcs cut)			
PS2801A-4-F4	PS2801A-4-F4-A		Embossed Tape 3 500 pcs/reel			
PS2801A-1-V	PS2801A-1-V-A		Magazine Case 45 pcs	PS2801A-1		
PS2801A-1-V-F3	PS2801A-1-V-F3-A		Embossed Tape 2 500 pcs/reel			
PS2801A-1-V-F4	PS2801A-1-V-F4-A		50 pcs (Tape 50 pcs cut)			
PS2801A-4-V	PS2801A-4-V-A		Embossed Tape 3 500 pcs/reel			
PS2801A-4-V-F3	PS2801A-4-V-F3-A		Magazine Case 45 pcs			
PS2801A-4-V-F4	PS2801A-4-V-F4-A		Embossed Tape 2 500 pcs/reel			

*1 For the application of the Safety Standard, following part number should be used.

ABSOLUTE MAXIMUM RATINGS (T_A = 25 °C, unless otherwise specified)

Parameter		Symbol	Ratings		Unit
			PS2801A-1	PS2801A-4	
Diode	Forward Current (DC)	I _F	30		mA
	Reverse Voltage	V _R	6		V
	Power Dissipation Derating	ΔP _D /°C	0.6	0.8	mW/°C
	Power Dissipation	P _D	60	80	mW/ch
	Peak Forward Current *1	I _{FP}	0.5		A
Transistor	Collector to Emitter Voltage	V _{CEO}	70		V
	Emitter to Collector Voltage	V _{ECO}	5		V
	Collector Current	I _C	30		mA/ch
	Power Dissipation Derating	ΔP _C /°C	1.2		mW/°C
	Power Dissipation	P _C	120		mW/ch
Isolation Voltage *2		BV	2 500		Vr.m.s.
Operating Ambient Temperature		T _A	-55 to +100		°C
Storage Temperature		T _{stg}	-55 to +150		°C

*1 PW = 100 μs, Duty Cycle = 1 %

*2 AC voltage for 1 minute at T_A = 25 °C, RH = 60 % between input and output

ELECTRICAL CHARACTERISTICS (T_A = 25 °C)

Parameter		Symbol	Conditions	MIN.	TYP.	MAX.	Unit
Diode	Forward Voltage	V _F	I _F = 5 mA		1.2	1.4	V
	Reverse Current	I _R	V _R = 5 V			5	μA
	Terminal Capacitance	C _t	V = 0 V, f = 1.0 MHz		10		pF
Transistor	Collector to Emitter Dark Current	I _{CEO}	V _{CE} = 70 V, I _F = 0 mA			100	nA
Coupled	Current Transfer Ratio (I _c /I _F) ^{*1}	CTR	I _F = 5 mA, V _{CE} = 5 V	50		400	%
	Collector Saturation Voltage	V _{CE(sat)}	I _F = 10 mA, I _c = 2 mA		0.13	0.3	V
	Isolation Resistance	R _{I-O}	V _{I-O} = 1.0 kV _{DC}	10 ¹¹			Ω
	Isolation Capacitance	C _{I-O}	V = 0 V, f = 1.0 MHz		0.4		pF
	Rise Time ^{*2}	t _r	V _{CC} = 5 V, I _c = 2 mA, R _L = 100 Ω		5		μs
	Fall Time ^{*2}	t _f			7		

***1 CTR rank**

PS2801A-1

N : 50 to 400 (%)

P : 150 to 300 (%)

L : 100 to 300 (%)

PS2801A-4

N : 50 to 400 (%)

***2 Test circuit for switching time**

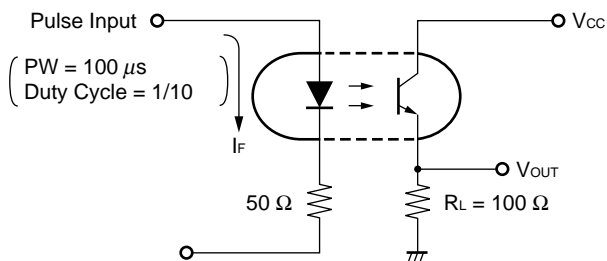

TYPICAL CHARACTERISTICS ($T_A = 25\text{ }^\circ\text{C}$, unless otherwise specified)

DIODE POWER DISSIPATION vs. AMBIENT TEMPERATURE

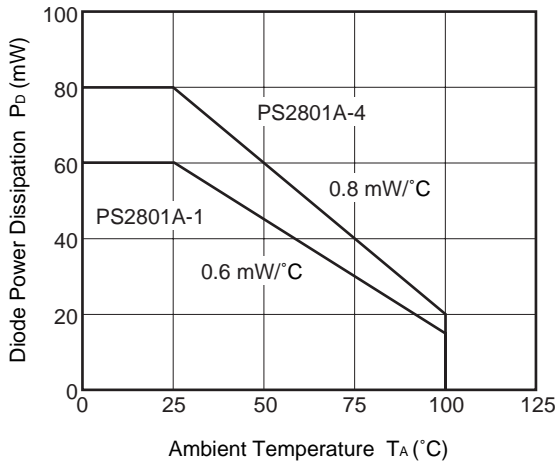

TRANSISTOR POWER DISSIPATION vs. AMBIENT TEMPERATURE

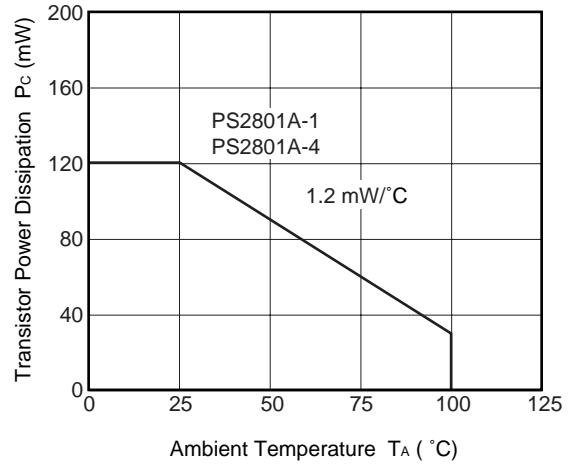

FORWARD CURRENT vs. FORWARD VOLTAGE

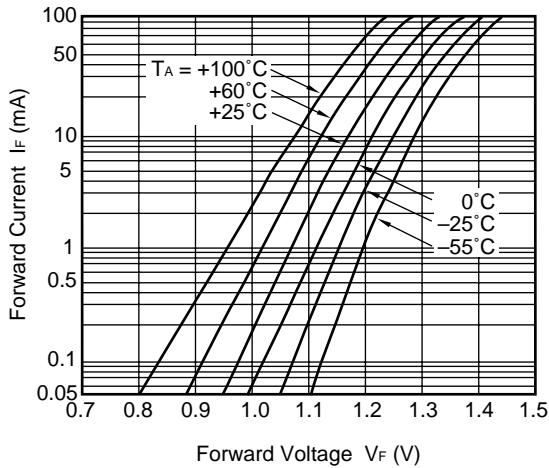

COLLECTOR CURRENT vs. COLLECTOR TO EMITTER VOLTAGE

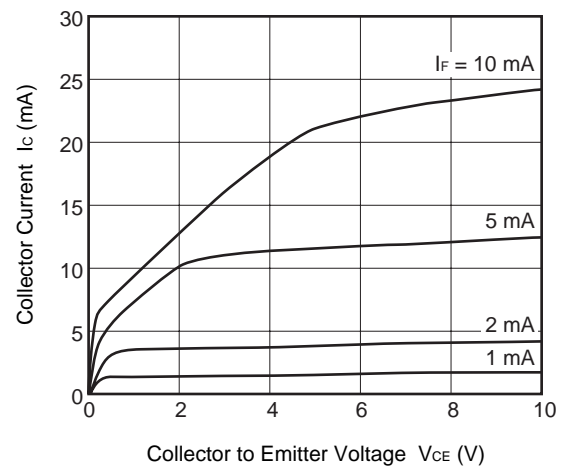

COLLECTOR TO EMITTER DARK CURRENT vs. AMBIENT TEMPERATURE

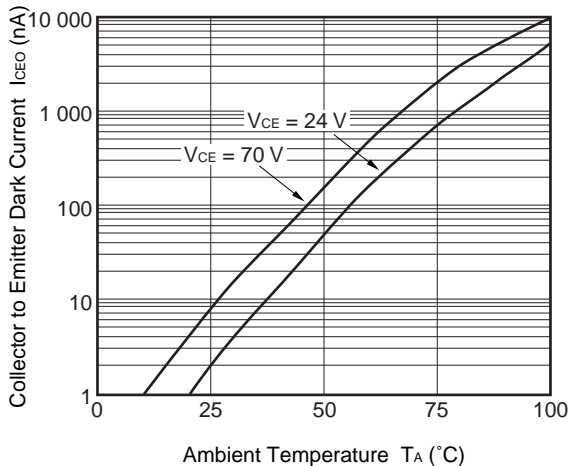

COLLECTOR CURRENT vs. COLLECTOR SATURATION VOLTAGE

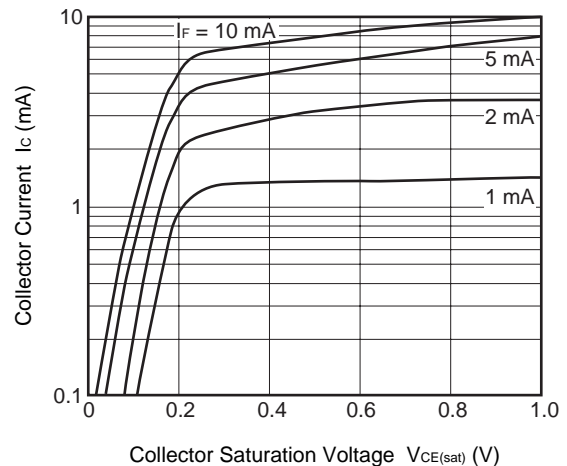

Remark The graphs indicate nominal characteristics.

★

NORMALIZED CURRENT TRANSFER RATIO vs. AMBIENT TEMPERATURE

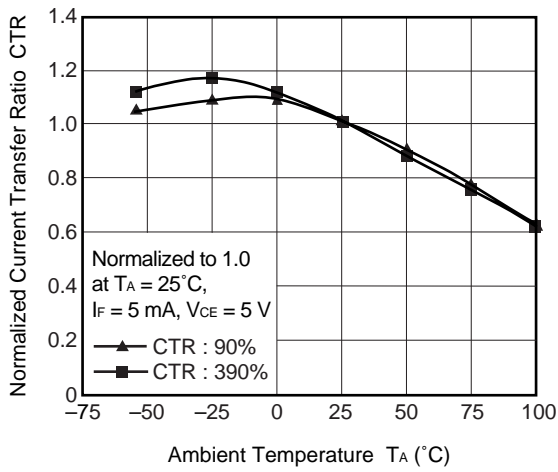

CURRENT TRANSFER RATIO vs. FORWARD CURRENT

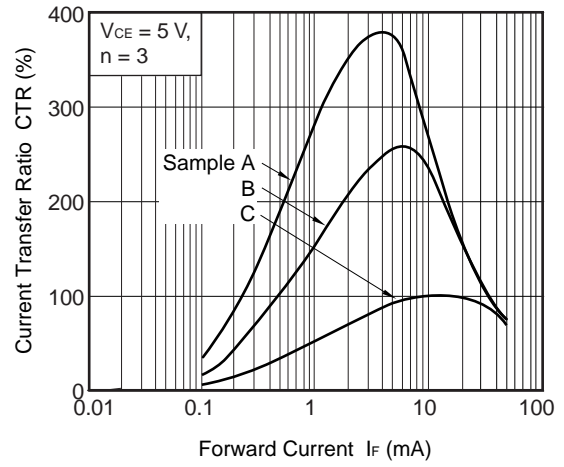

SWITCHING TIME vs. LOAD RESISTANCE

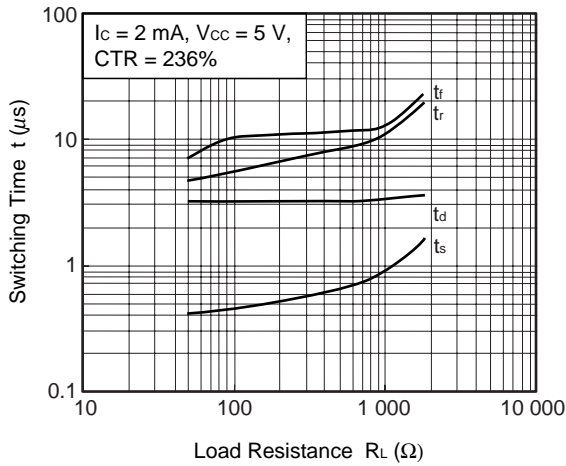

SWITCHING TIME vs. LOAD RESISTANCE

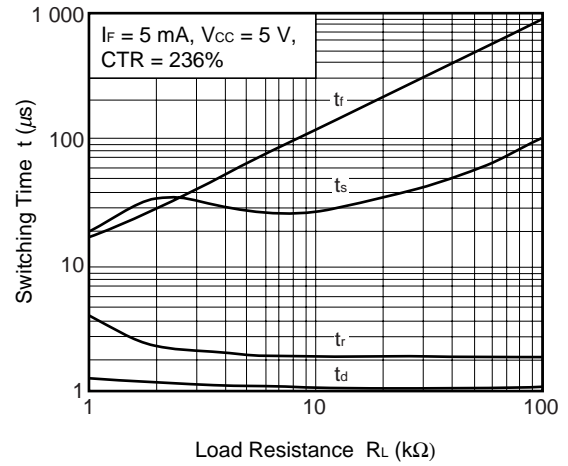

FREQUENCY RESPONSE

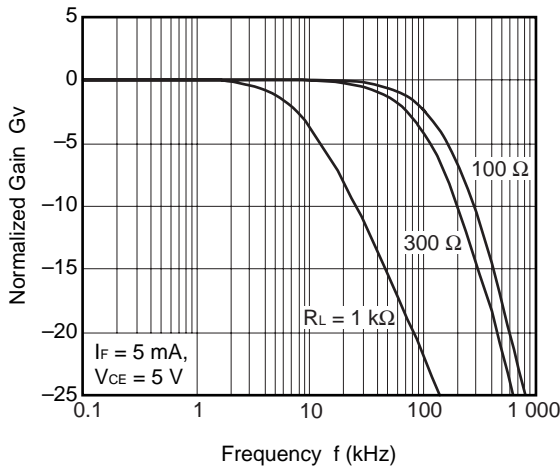

LONG TERM CTR DEGRADATION

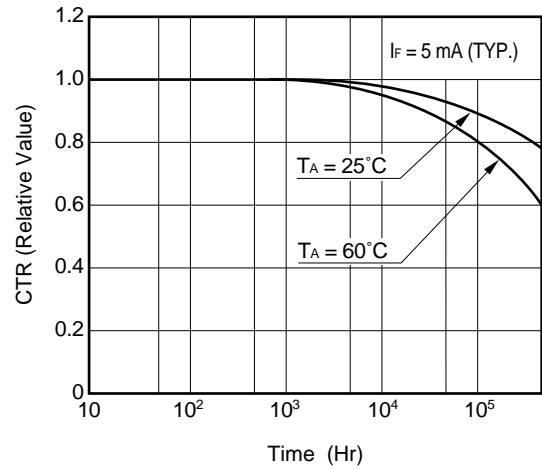

Remark The graphs indicate nominal characteristics.

TAPING SPECIFICATIONS (UNIT: mm)

Outline and Dimensions (Tape)

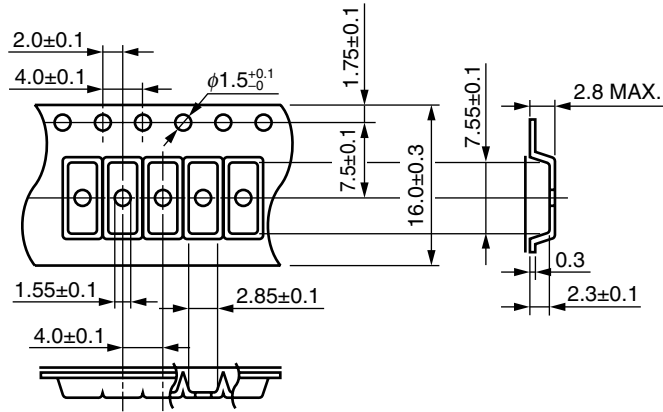

Tape Direction

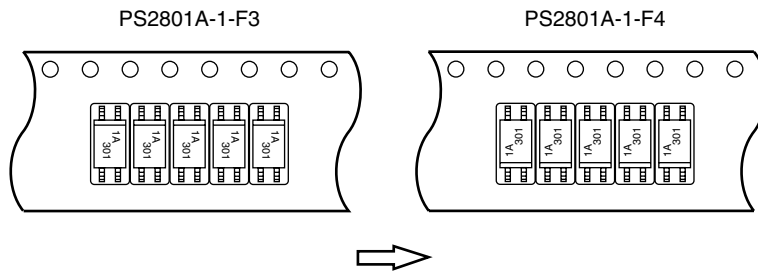

Outline and Dimensions (Reel)



Outline and Dimensions (Tape)

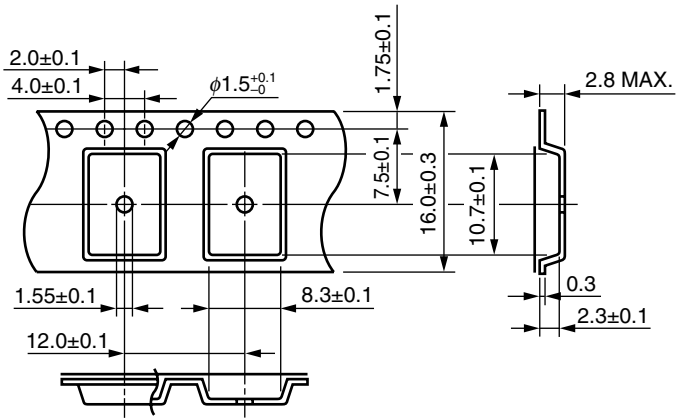

Tape Direction

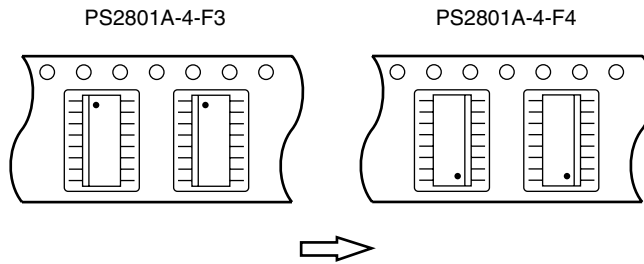

Outline and Dimensions (Reel)

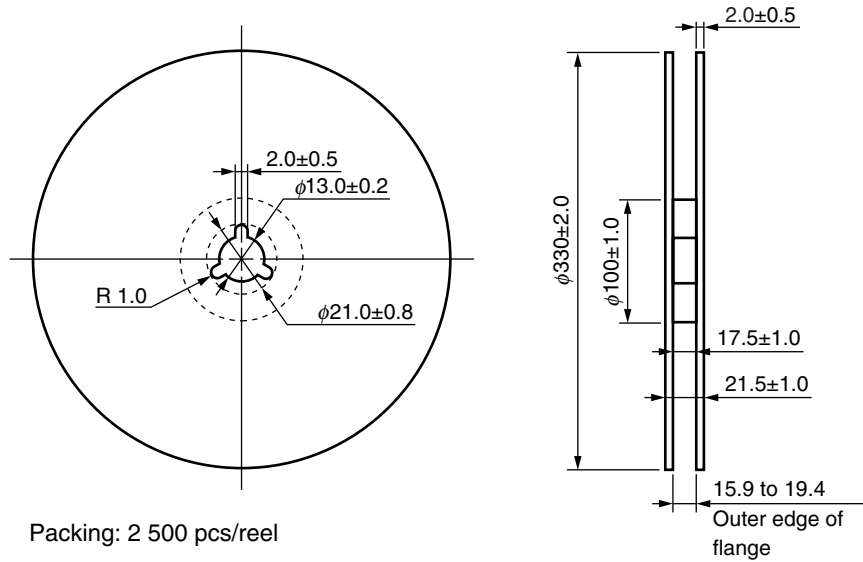

NOTES ON HANDLING

1. Recommended soldering conditions

(1) Infrared reflow soldering

- Peak reflow temperature 260°C or below (package surface temperature)
- Time of peak reflow temperature 10 seconds or less
- Time of temperature higher than 220°C 60 seconds or less
- Time to preheat temperature from 120 to 180°C 120±30 s
- Number of reflows Three
- Flux Rosin flux containing small amount of chlorine (The flux with a maximum chlorine content of 0.2 Wt% is recommended.)

Recommended Temperature Profile of Infrared Reflow

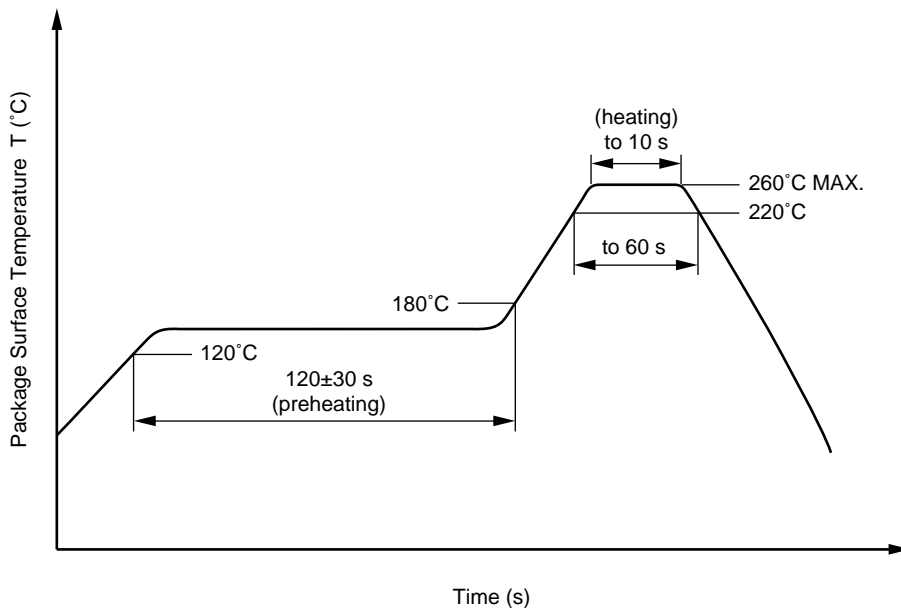

(2) Wave soldering

- Temperature 260°C or below (molten solder temperature)
- Time 10 seconds or less
- Preheating conditions 120°C or below (package surface temperature)
- Number of times One (Allowed to be dipped in solder including plastic mold portion.)
- Flux Rosin flux containing small amount of chlorine (The flux with a maximum chlorine content of 0.2 Wt% is recommended.)

(3) Soldering by Soldering Iron

- Peak Temperature (lead part temperature) 350°C or below
- Time (each pins) 3 seconds or less
- Flux Rosin flux containing small amount of chlorine (The flux with a maximum chlorine content of 0.2 Wt% is recommended.)

(a) Soldering of leads should be made at the point 1.5 to 2.0 mm from the root of the lead

(b) Please be sure that the temperature of the package would not be heated over 100°C

(4) Cautions

- Fluxes

Avoid removing the residual flux with freon-based and chlorine-based cleaning solvent.

2. Cautions regarding noise

Be aware that when voltage is applied suddenly between the photocoupler's input and output or between collector-emitters at startup, the output transistor may enter the on state, even if the voltage is within the absolute maximum ratings.

USAGE CAUTIONS

1. Protect against static electricity when handling.
2. Avoid storage at a high temperature and high humidity.

Subject: Compliance with EU Directives

CEL certifies, to its knowledge, that semiconductor and laser products detailed below are compliant with the requirements of European Union (EU) Directive 2002/95/EC Restriction on Use of Hazardous Substances in electrical and electronic equipment (RoHS) and the requirements of EU Directive 2003/11/EC Restriction on Penta and Octa BDE.

CEL Pb-free products have the same base part number with a suffix added. The suffix –A indicates that the device is Pb-free. The –AZ suffix is used to designate devices containing Pb which are exempted from the requirement of RoHS directive (*). In all cases the devices have Pb-free terminals. All devices with these suffixes meet the requirements of the RoHS directive.

This status is based on CEL’s understanding of the EU Directives and knowledge of the materials that go into its products as of the date of disclosure of this information.

Restricted Substance per RoHS	Concentration Limit per RoHS (values are not yet fixed)	Concentration contained in CEL devices	
		-A	-AZ
Lead (Pb)	< 1000 PPM	Not Detected	(*)
Mercury	< 1000 PPM	Not Detected	
Cadmium	< 100 PPM	Not Detected	
Hexavalent Chromium	< 1000 PPM	Not Detected	
PBB	< 1000 PPM	Not Detected	
PBDE	< 1000 PPM	Not Detected	

If you should have any additional questions regarding our devices and compliance to environmental standards, please do not hesitate to contact your local representative.

Important Information and Disclaimer: Information provided by CEL on its website or in other communications concerning the substance content of its products represents knowledge and belief as of the date that it is provided. CEL bases its knowledge and belief on information provided by third parties and makes no representation or warranty as to the accuracy of such information. Efforts are underway to better integrate information from third parties. CEL has taken and continues to take reasonable steps to provide representative and accurate information but may not have conducted destructive testing or chemical analysis on incoming materials and chemicals. CEL and CEL suppliers consider certain information to be proprietary, and thus CAS numbers and other limited information may not be available for release.

In no event shall CEL’s liability arising out of such information exceed the total purchase price of the CEL part(s) at issue sold by CEL to customer on an annual basis.

See CEL Terms and Conditions for additional clarification of warranties and liability.