

PT431/PT431F

Narrow Acceptance, High Sensitivity Phototransistor T-41-63

■ Features

1. Narrow acceptance epoxy resin package ($\Delta\theta$: TYP. $\pm 13^\circ$)
2. High sensitivity (PT431 I_c : MIN. 2mA, PT431F I_c : MIN. 1.3mA at $E_e=0.1\text{mW/cm}^2$)
3. Visible light cut-off type: PT431F

■ Applications

1. Copiers, Printers, automatic vending machines
2. VCRs, cassette decks
3. Optoelectronic switches, optoelectronic counters

■ Outline Dimensions

(Unit: mm)

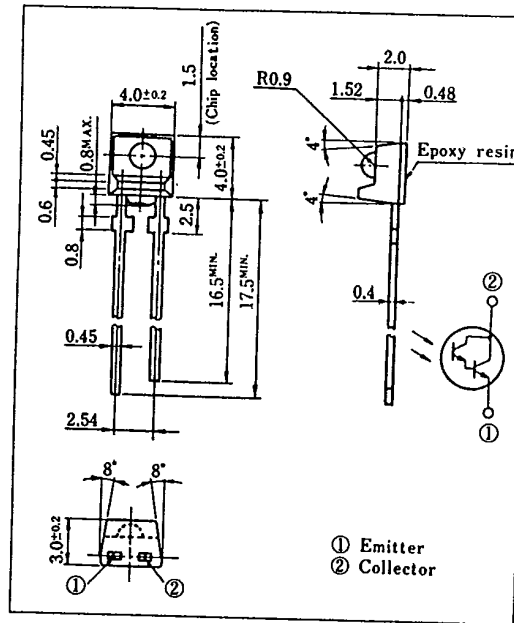

■ Absolute Maximum Ratings

($T_a=25^\circ\text{C}$)

Parameter	Symbol	Rating	Unit
Collector-emitter voltage	V_{CE0}	35	V
Emitter-collector voltage	V_{ECO}	6	V
Collector current	I_c	50	mA
Collector power dissipation	P_c	75	mW
Operating temperature	T_{opr}	-25 ~ +85	$^\circ\text{C}$
Storage temperature	T_{stg}	-40 ~ +85	$^\circ\text{C}$
*1 Soldering temperature	T_{sol}	260	$^\circ\text{C}$

*1 For 3 seconds at the position of 2.5mm from the bottom face of resin package

■ Electro-optical Characteristics

($T_a=25^\circ\text{C}$)

Parameter	Symbol	Conditions	MIN.	TYP.	MAX.	Unit
*2 Collector current	PT431	$V_{CE}=2\text{V}$ $E_e=0.1\text{mW/cm}^2$	2	—	—	mA
	PT431F		1.3	8.0	45	mA
Collector dark current	I_{CEO}	$V_{CE}=10\text{V}$, $E_e=0$	—	—	10^{-6}	A
*2 Collector-emitter saturation voltage	$V_{CE(sat)}$	$I_c=2.5\text{mA}$, $E_e=1\text{mW/cm}^2$	—	—	1.0	V
Peak sensitivity wavelength	PT431		—	800	—	nm
	PT431F		—	860	—	nm
Response time (Rise)	t_r	$V_{CE}=2\text{V}$, $I_c=10\text{mA}$, $R_L=100\Omega$	—	80	—	μs
Response time (Fall)	t_f		—	70	—	μs

*2 E_e : Irradiance by CIE standard light source A (tungsten lamp)

Fig. 1 Collector Power Dissipation vs. Ambient Temperature

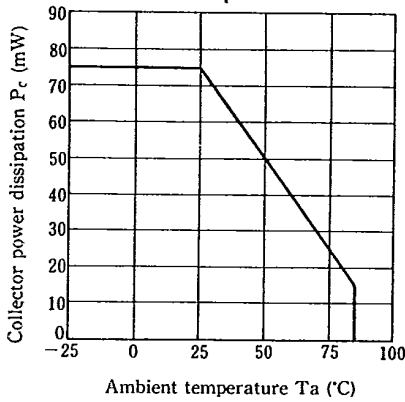

Fig. 2 Collector Dark Current vs. Ambient Temperature

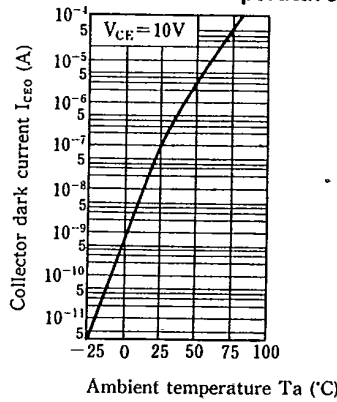

Fig. 3 Relative Collector Current vs. Ambient Temperature

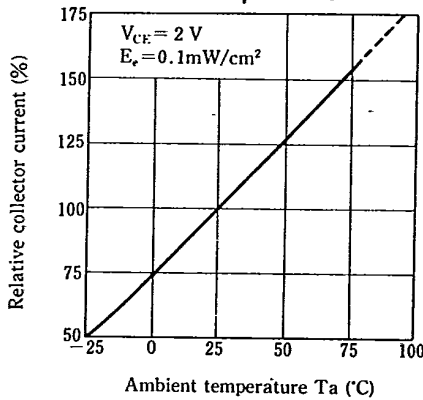
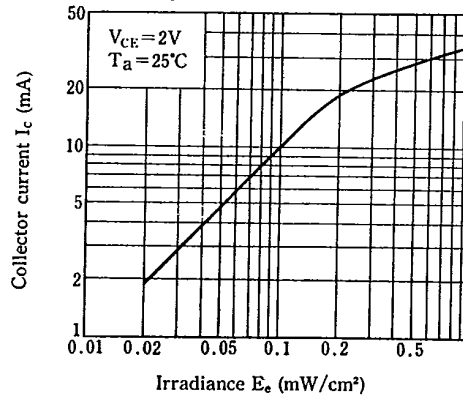

Fig. 4 Collector Current vs. Irradiance (PT431)



5

Fig. 5 Collector Current vs. Irradiance (PT431F)

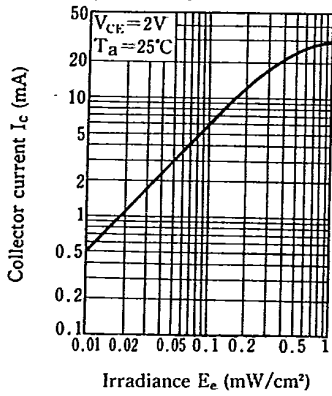
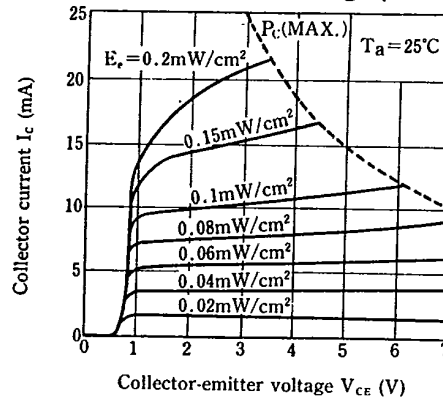

Fig. 6 Collector Current vs. Collector-emitter Voltage (PT431)



T-41-61

Fig. 7 Collector Current vs. Collector-emitter Voltage (PT431F)

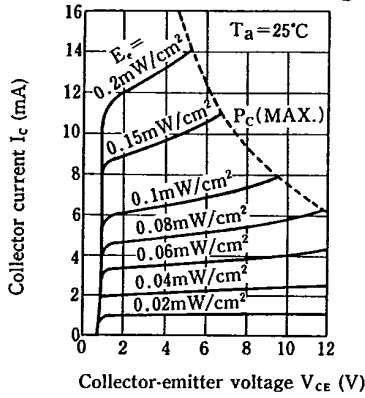

Fig. 8 Spectral Sensitivity (PT431)

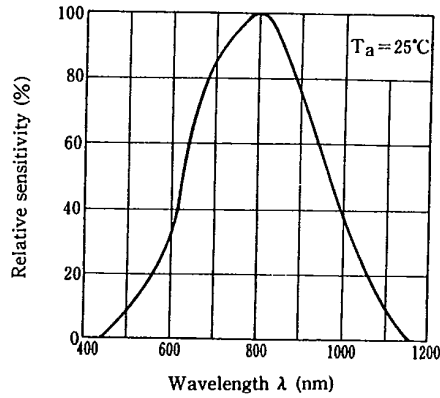

Fig. 9 Spectral Sensitivity (PT431F)

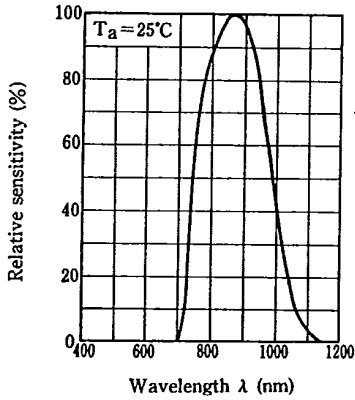
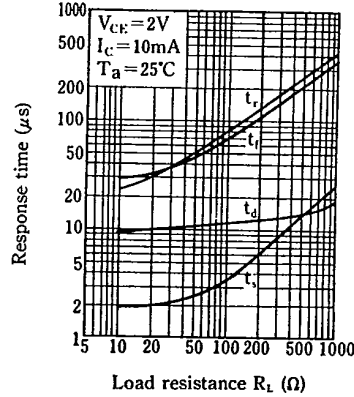

Fig. 10 Response Time vs. Load Resistance



Test Circuit for Response Time

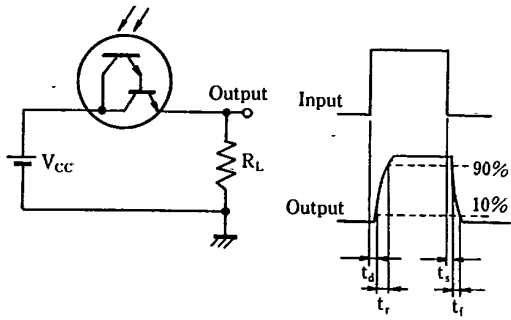

Fig. 11 Sensitivity Diagram (Ta=25°C)

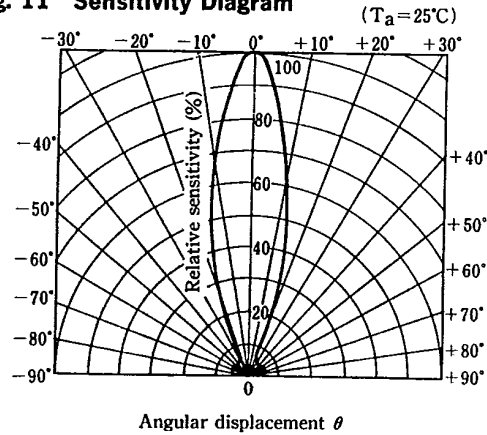

Fig. 12 Collector-emitter Saturation Voltage vs. Irradiance (PT431)

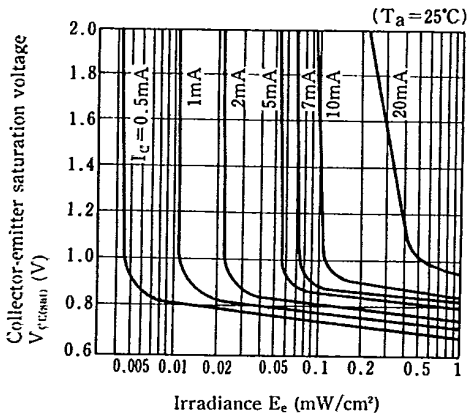

Fig. 13 Collector-emitter Saturation Voltage vs. Irradiance (PT431F)

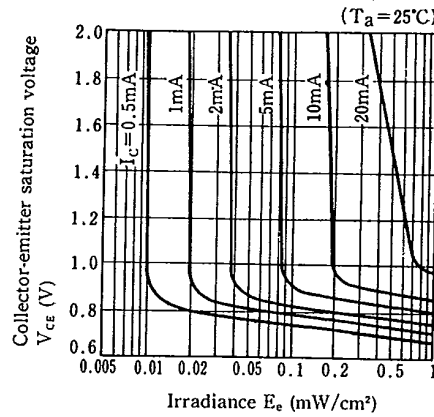

Fig. 14 Relative Output vs. Distance (Emitter : GL430)

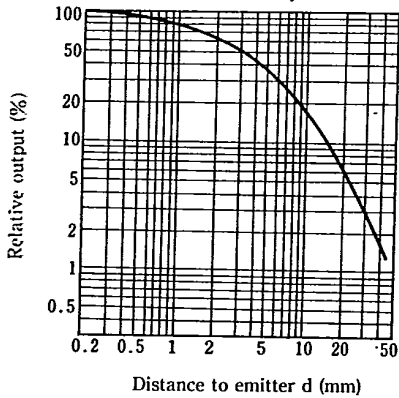
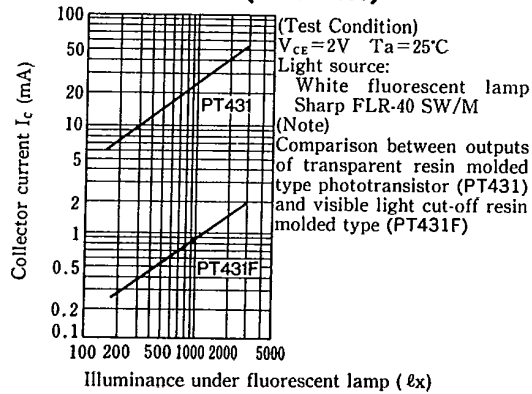

Fig. 15 Collector Current vs. Illuminance (Reference)



5