

Zener diode

PTZ33B

●Applications
Voltage regulation

●Features
1) Small power mold type. (PMDS)
2) High ESD tolerance

●Construction
Silicon epitaxial planar

●External dimensions (Unit : mm)

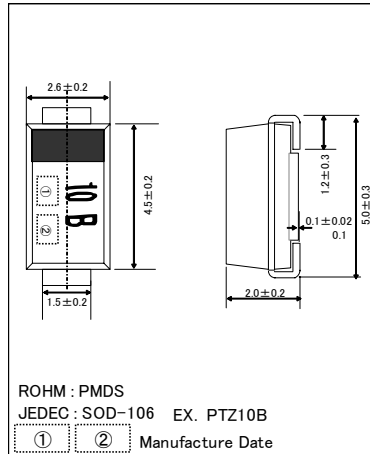

●Land size figure (Unit : mm)

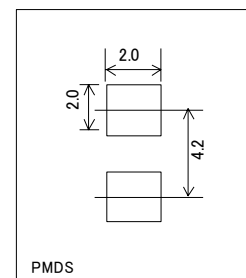

●Structure

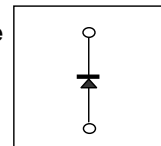

●Taping dimensions (Unit : mm)

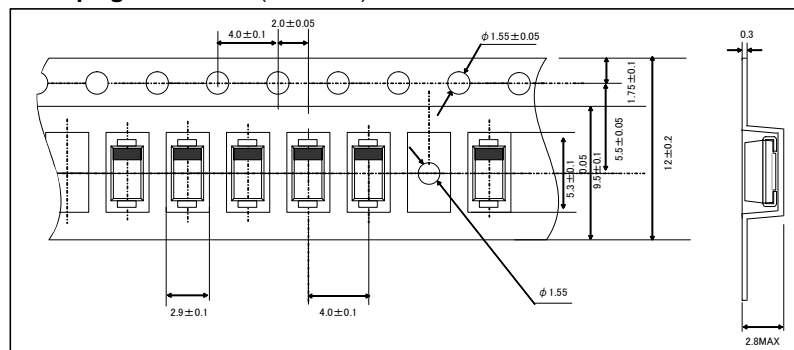

●Absolute maximum ratings (Ta=25°C)

Parameter	Symbol	Limits	Unit
Power dissipation	P	1000	mW
Junction temperature	T _j	150	°C
Storage temperature	T _{stg}	-55 to +150	°C

Diodes

●Electrical characteristics (Ta=25°C)

TYP.	Symbol											MIN.	Test Condition
	Zener voltage : Vz(V)			Operating resistance : Zz(Ω)		Reverse current : IR(μA)		Temperature coefficient : *γz(mV/°C)		ESD Break down voltage : ESD(kV)			
	MIN.	TYP.	MAX.	Iz(mA)	Max.	Iz(mA)	MAX.	VR(V)	TYP.	Iz(mA)			
PTZ 3.6B	3.600	3.813	4.000	40	15	40	60	1.0	-2.8	40	30kV	C=150pF R=330Ω forward and reverse : 10 times	
PTZ 3.9B	3.900	4.136	4.400	40	15	40	40	1.0	-2.4	40			
PTZ 4.3B	4.300	4.572	4.800	40	15	40	20	1.0	-2.1	40			
PTZ 4.7B	4.700	4.924	5.200	40	10	40	20	1.0	-1.7	40			
PTZ 5.1B	5.100	5.368	5.700	40	8	40	20	1.5	-0.6	40			
PTZ 5.6B	5.600	5.856	6.300	40	8	40	20	2.5	1.4	40			
PTZ 6.2B	6.200	6.509	7.000	40	6	40	20	3.0	2.5	40			
PTZ 6.8B	6.800	7.280	7.700	40	6	40	20	3.5	3.2	40			
PTZ 7.5B	7.500	7.889	8.400	40	4	40	20	4.0	4.2	40			
PTZ 8.2B	8.200	8.655	9.300	40	4	40	20	5.0	5.0	40			
PTZ 9.1B	9.100	9.747	10.200	40	6	40	20	6.0	5.9	40			
PTZ 10B	10.000	10.310	11.200	40	6	40	10	7.0	6.9	40			
PTZ 11B	11.000	11.510	12.300	20	8	20	10	8.0	7.9	20			
PTZ 12B	12.000	12.500	13.500	20	8	20	10	9.0	8.7	20			
PTZ 13B	13.300	13.820	15.000	20	10	20	10	10.0	10.1	20			
PTZ 15B	14.700	15.350	16.500	20	10	20	10	11.0	11.8	20			
PTZ 16B	16.200	16.860	18.300	20	12	20	10	12.0	13.3	20			
PTZ 18B	18.000	19.000	20.300	20	12	20	10	13.0	15.0	20			
PTZ 20B	20.000	20.820	22.400	20	14	20	10	15.0	17.4	20			
PTZ 22B	22.000	23.850	24.500	10	14	10	10	17.0	19.4	10			
PTZ 24B	24.000	25.310	27.600	10	16	10	10	19.0	21.6	10			
PTZ 27B	27.000	28.700	30.800	10	16	10	10	21.0	24.6	10			
PTZ 30B	30.000	31.570	34.000	10	18	10	10	23.0	27.5	10			
PTZ 33B	33.000	34.950	37.000	10	18	10	10	25.0	30.8	10			
PTZ 36B	36.000	39.240	40.000	10	20	10	10	27.0	37.0	10			

1.The Zener voltage(Vz) is measured 40ms after power is supplied.

2.The operating resistances(Zz, Zzk) are measured by superimposing a minute alternating current on the regulated current(Iz).

●Marking (TYPE NO.)

TYPE	TYPE NO.	TYPE	TYPE NO.	TYPE	TYPE NO.
PTZ 3.6B	3.6B	PTZ 8.2B	8.2B	PTZ 20B	20B
PTZ 3.9B	3.9B	PTZ 9.1B	9.1B	PTZ 22B	22B
PTZ 4.3B	4.3B	PTZ 10B	10B	PTZ 24B	24B
PTZ 4.7B	4.7B	PTZ 11B	11B	PTZ 27B	27B
PTZ 5.1B	5.1B	PTZ 12B	12B	PTZ 30B	30B
PTZ 5.6B	5.6B	PTZ 13B	13B	PTZ 33B	33B
PTZ 6.2B	6.2B	PTZ 15B	15B	PTZ 36B	36B
PTZ 6.8B	6.8B	PTZ 16B	16B		
PTZ 7.5B	7.5B	PTZ 18B	18B		

Diodes

●Electrical characteristic curves (Ta=25°C)

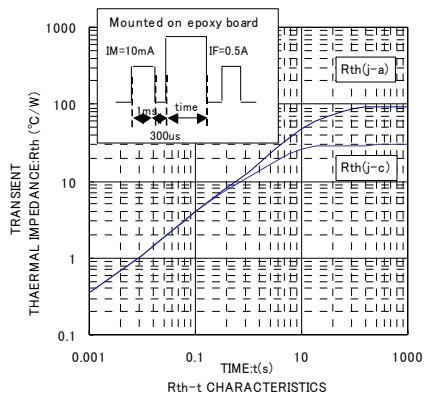
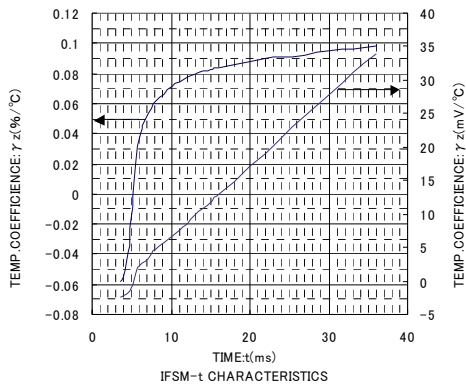
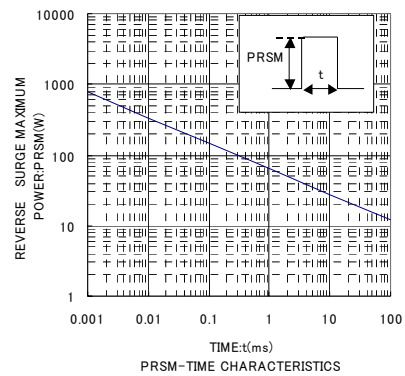
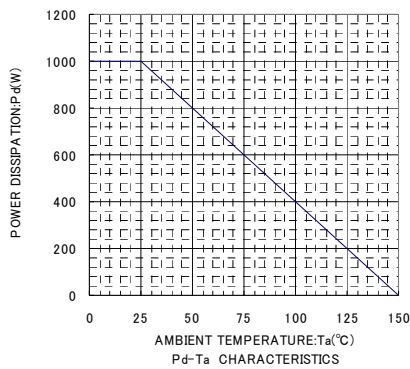

Diodes

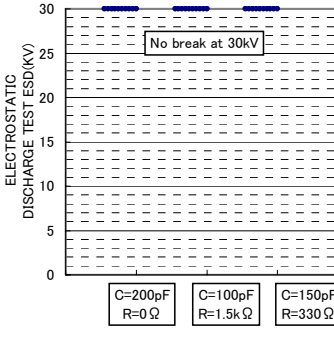
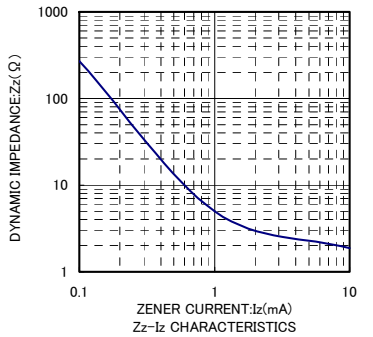
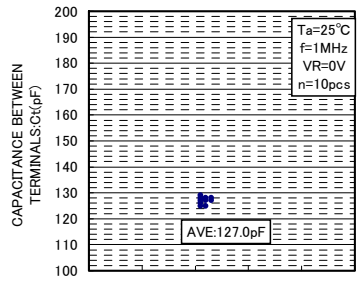
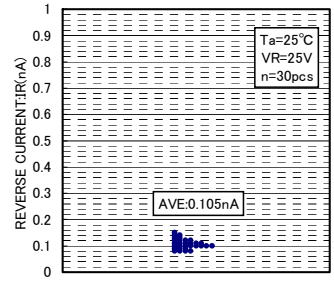
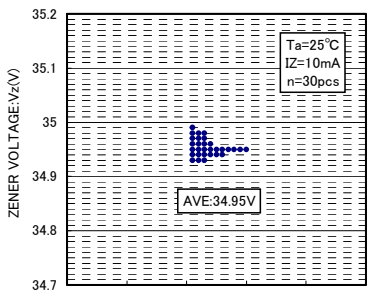
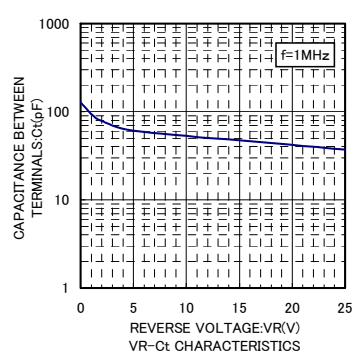
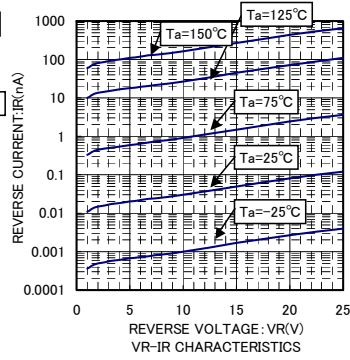
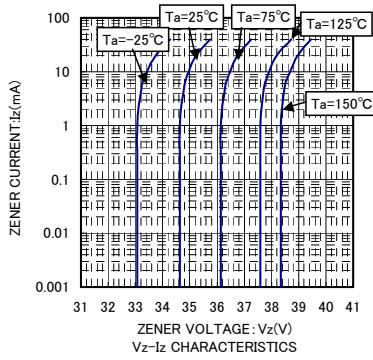

Notes

- No technical content pages of this document may be reproduced in any form or transmitted by any means without prior permission of ROHM CO.,LTD.
- The contents described herein are subject to change without notice. The specifications for the product described in this document are for reference only. Upon actual use, therefore, please request that specifications to be separately delivered.
- Application circuit diagrams and circuit constants contained herein are shown as examples of standard use and operation. Please pay careful attention to the peripheral conditions when designing circuits and deciding upon circuit constants in the set.
- Any data, including, but not limited to application circuit diagrams information, described herein are intended only as illustrations of such devices and not as the specifications for such devices. ROHM CO.,LTD. disclaims any warranty that any use of such devices shall be free from infringement of any third party's intellectual property rights or other proprietary rights, and further, assumes no liability of whatsoever nature in the event of any such infringement, or arising from or connected with or related to the use of such devices.
- Upon the sale of any such devices, other than for buyer's right to use such devices itself, resell or otherwise dispose of the same, no express or implied right or license to practice or commercially exploit any intellectual property rights or other proprietary rights owned or controlled by
- ROHM CO., LTD. is granted to any such buyer.
- Products listed in this document are no antiradiation design.

The products listed in this document are designed to be used with ordinary electronic equipment or devices (such as audio visual equipment, office-automation equipment, communications devices, electrical appliances and electronic toys).

Should you intend to use these products with equipment or devices which require an extremely high level of reliability and the malfunction of which would directly endanger human life (such as medical instruments, transportation equipment, aerospace machinery, nuclear-reactor controllers, fuel controllers and other safety devices), please be sure to consult with our sales representative in advance.

About Export Control Order in Japan

Products described herein are the objects of controlled goods in Annex 1 (Item 16) of Export Trade Control Order in Japan.

In case of export from Japan, please confirm if it applies to "objective" criteria or an "informed" (by MITI clause) on the basis of "catch all controls for Non-Proliferation of Weapons of Mass Destruction.