

PNP Silicon Darlington Transistors

PZTA 63
PZTA 64

- For general AF applications
- High collector current
- High current gain
- Complementary types: PZTA 13, PZTA 14 (NPN)

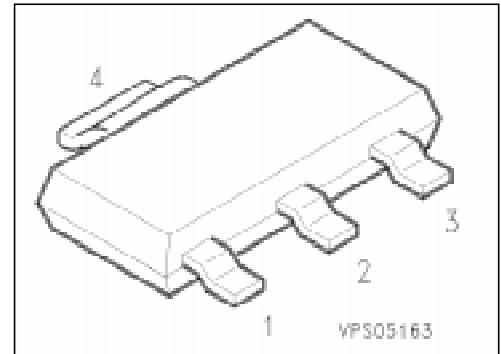

| Type | Marking | Ordering Code (tape and reel) | Pin Configuration | | | | Package ¹⁾ |
|--------------------|--------------------|----------------------------------|-------------------|---|---|---|-----------------------|
| | | | 1 | 2 | 3 | 4 | |
| PZTA 63 PZTA 64 | PZTA 63 PZTA 64 | Q62702-Z2031 Q62702-Z2032 | B | C | E | C | SOT-223 |

Maximum Ratings

| Parameter | Symbol | Values | Unit |
|--|-----------|----------------|------|
| Collector-emitter voltage | V_{CES} | 30 | V |
| Collector-base voltage | V_{CB0} | 30 | |
| Emitter-base voltage | V_{EB0} | 10 | |
| Collector current | I_C | 500 | mA |
| Peak collector current | I_{CM} | 800 | |
| Base current | I_B | 100 | |
| Peak base current | I_{BM} | 200 | |
| Total power dissipation, $T_s = 124\text{ °C}$ | P_{tot} | 1.5 | W |
| Junction temperature | T_j | 150 | °C |
| Storage temperature range | T_{stg} | - 65 ... + 150 | |

Thermal Resistance

| | | | |
|----------------------------------|--------------|------|-----|
| Junction - ambient ²⁾ | $R_{th\ JA}$ | ≤ 72 | K/W |
| Junction - soldering point | $R_{th\ JS}$ | ≤ 17 | |

¹⁾ For detailed information see chapter Package Outlines.

²⁾ Package mounted on epoxy pcb 40 mm × 40 mm × 1.5 mm/6 cm² Cu.

Electrical Characteristics

at $T_A = 25\text{ °C}$, unless otherwise specified.

| Parameter | Symbol | Values | | | Unit |
|-----------|--------|--------|------|------|------|
| | | min. | typ. | max. | |

DC characteristics

| | | | | | |
|--|---------------|----|---|-----------|---------------------|
| Collector-emitter breakdown voltage $I_C = 100\text{ }\mu\text{A}$ | $V_{(BR)CES}$ | 30 | – | – | V |
| Collector-base breakdown voltage $I_C = 100\text{ }\mu\text{A}, I_B = 0$ | $V_{(BR)CB0}$ | 30 | – | – | |
| Emitter-base breakdown voltage $I_E = 10\text{ }\mu\text{A}, I_C = 0$ | $V_{(BR)EB0}$ | 10 | – | – | |
| Collector-base cutoff current $V_{CE} = 30\text{ V}, I_E = 0$ $V_{CE} = 30\text{ V}, I_E = 0, T_A = 150\text{ °C}$ | I_{CB0} | – | – | 100 10 | nA μA |
| Emitter-base cutoff current $V_{EB} = 10\text{ V}, I_C = 0$ | I_{EB0} | – | – | 100 | nA |
| DC current gain $I_C = 10\text{ mA}, V_{CE} = 5\text{ V}$ $I_C = 100\text{ mA}, V_{CE} = 5\text{ V}$ | h_{FE} | | | | – |
| | | | | | |
| | | | | | |
| | | | | | |
| | | | | | |
| Collector-emitter saturation voltage ¹⁾ $I_C = 100\text{ mA}, I_B = 0.1\text{ mA}$ | V_{CEsat} | – | – | 1.5 | V |
| Base-emitter saturation voltage ¹⁾ $I_C = 100\text{ mA}, I_B = 0.1\text{ mA}$ | V_{BEsat} | – | – | 2.0 | |

AC characteristics

| | | | | | |
|---|-------|-----|---|---|-----|
| Transition frequency $I_C = 50\text{ mA}, V_{CE} = 5\text{ V}, f = 100\text{ MHz}$ | f_T | 125 | – | – | MHz |
|---|-------|-----|---|---|-----|

¹⁾ Pulse test conditions: $t \leq 300\text{ }\mu\text{s}, D = 2\%$.

Total power dissipation $P_{tot} = f(T_A^*; T_S)$

* Package mounted on epoxy

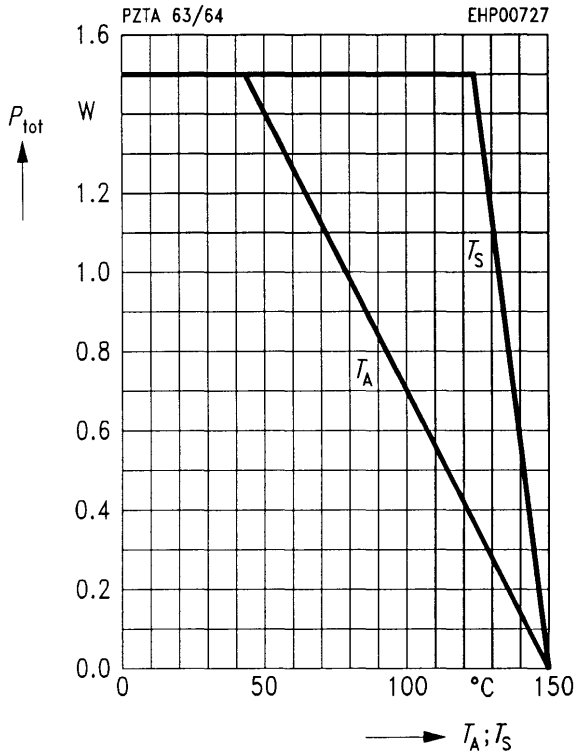

Transition frequency $f_T = f(I_C)$

$V_{CE} = 5 V, f = 100 MHz$

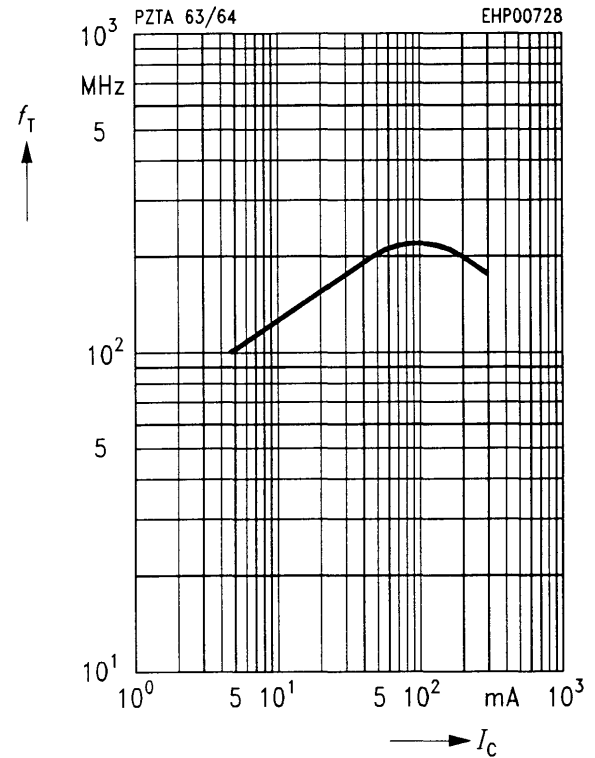

Permissible pulse load $P_{tot max} / P_{tot DC} = f(t_p)$

DC current gain $h_{FE} = f(I_C)$

$V_{CE} = 5 V$

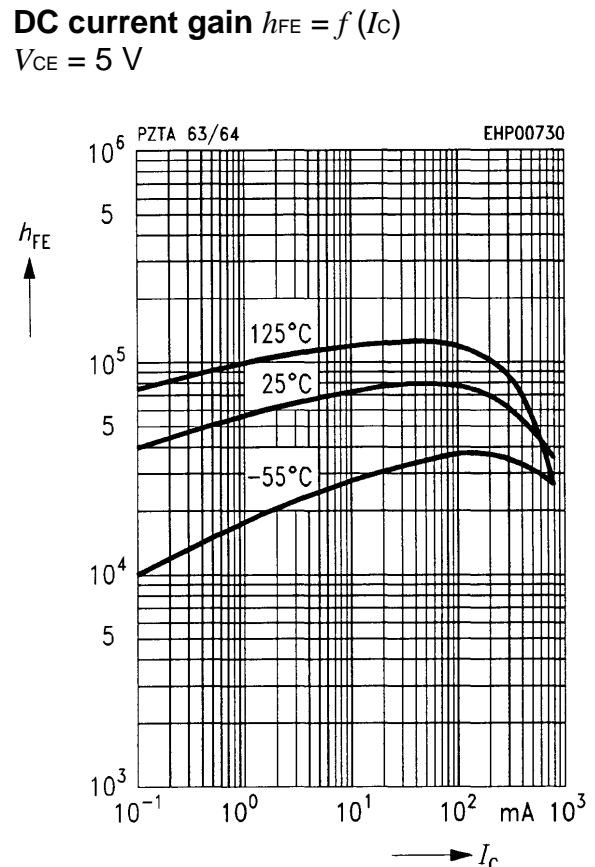
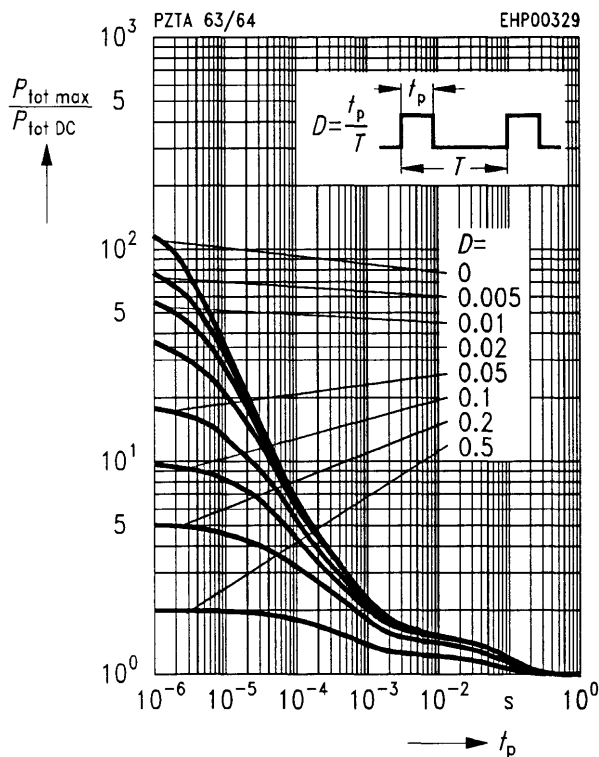

Collector-emitter saturation voltage

$I_C = f(V_{CE\ sat})$

$h_{FE} = 1000$

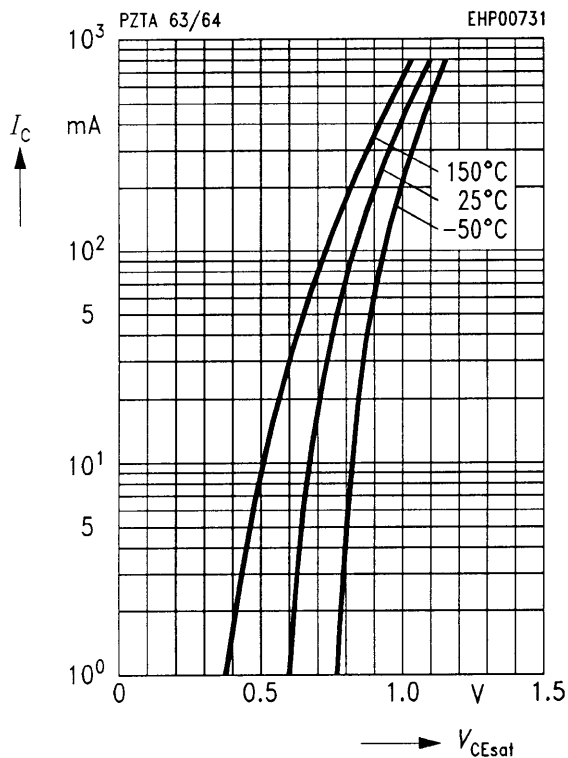

Base-emitter saturation voltage

$I_C = f(V_{BE\ sat})$

$h_{FE} = 1000$

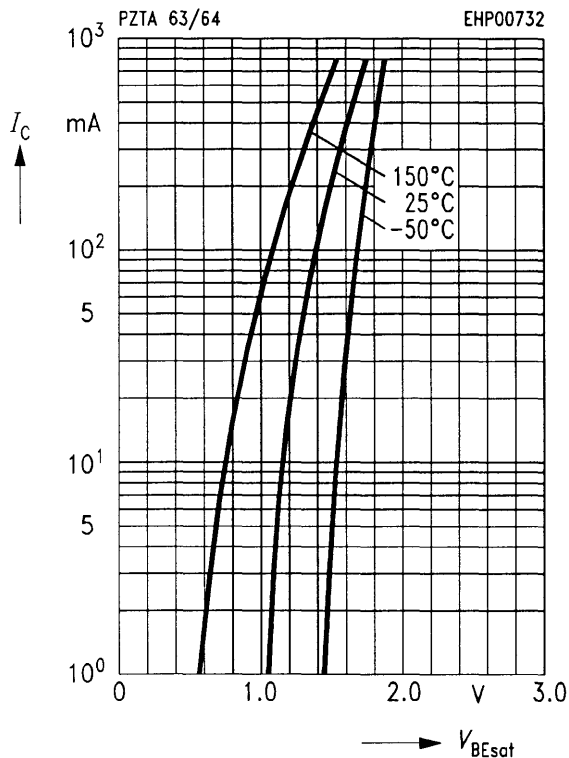

Collector cutoff current $I_{CB0} = f(T_A)$

$V_{CE} = 30\ V$

