

## PNP Silicon Darlington Transistor

**BC 516**

- High current gain
- High collector current
- Complementary type: BC 517 (NPN)

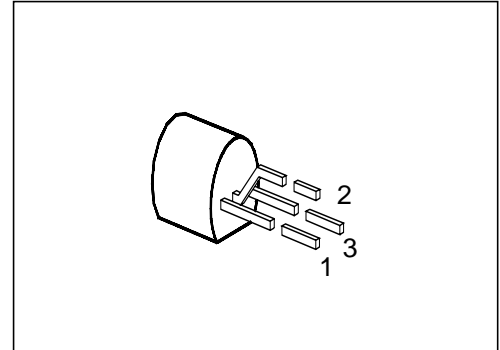

Type	Marking	Ordering Code	Pin Configuration			Package <sup>1)</sup>
			1	2	3	
BC 516	–	Q62702-C944	C	B	E	TO-92

### Maximum Ratings

Parameter	Symbol	Values	Unit
Collector-emitter voltage	$V_{CE0}$	30	V
Collector-base voltage	$V_{CB0}$	40	
Emitter-base voltage	$V_{EB0}$	10	
Collector current	$I_C$	500	mA
Peak collector current	$I_{CM}$	800	
Base current	$I_B$	100	
Peak base current	$I_{BM}$	200	
Total power dissipation, $T_c = 66\text{ °C}$	$P_{tot}$	625	mW
Junction temperature	$T_j$	150	°C
Storage temperature range	$T_{stg}$	– 65 ... + 150	

### Thermal Resistance

Junction - ambient	$R_{th\ JA}$	≤ 200	K/W
Junction - case <sup>2)</sup>	$R_{th\ JC}$	≤ 135	

<sup>1)</sup> For detailed information see chapter Package Outlines.

<sup>2)</sup> Mounted on Al heat sink 15 mm × 25 mm × 0.5 mm.

## Electrical Characteristics

at  $T_A = 25\text{ °C}$ , unless otherwise specified.

Parameter	Symbol	Values			Unit
		min.	typ.	max.	

### DC characteristics

Collector-emitter breakdown voltage $I_C = 10\text{ mA}$	$V_{(BR)CE0}$	30	–	–	V
Collector-base breakdown voltage $I_C = 100\text{ }\mu\text{A}$	$V_{(BR)CB0}$	40	–	–	
Emitter-base breakdown voltage $I_E = 10\text{ }\mu\text{A}$	$V_{(BR)EB0}$	10	–	–	
Collector cutoff current $V_{CB} = 30\text{ V}$ $V_{CB} = 30\text{ V}, T_A = 150\text{ °C}$	$I_{CB0}$	–	–	100 10	nA $\mu\text{A}$
Emitter cutoff current $V_{EB} = 4\text{ V}$	$I_{EB0}$	–	–	100	$\mu\text{A}$
DC current gain $I_C = 20\text{ mA}; V_{CE} = 2\text{ V}$	$h_{FE}$	30 000	–	–	–
Collector-emitter saturation voltage <sup>1)</sup> $I_C = 100\text{ mA}; I_B = 0.1\text{ mA}$	$V_{CEsat}$	–	–	1	V
Base-emitter voltage <sup>1)</sup> $I_C = 10\text{ mA}; V_{CE} = 5\text{ V}$	$V_{BE}$	–	–	1.4	

### AC characteristics

Transition frequency $I_C = 50\text{ mA}, V_{CE} = 5\text{ V}, f = 20\text{ MHz}$	$f_T$	–	200	–	MHz
Output capacitance $V_{CB} = 10\text{ V}, f = 1\text{ MHz}$	$C_{obo}$	–	3.5	–	pF

<sup>1)</sup> Pulse test:  $t \leq 300\text{ }\mu\text{s}, D \leq 2\text{ %}$ .

**Total power dissipation  $P_{tot} = f(T_A; T_C)$**

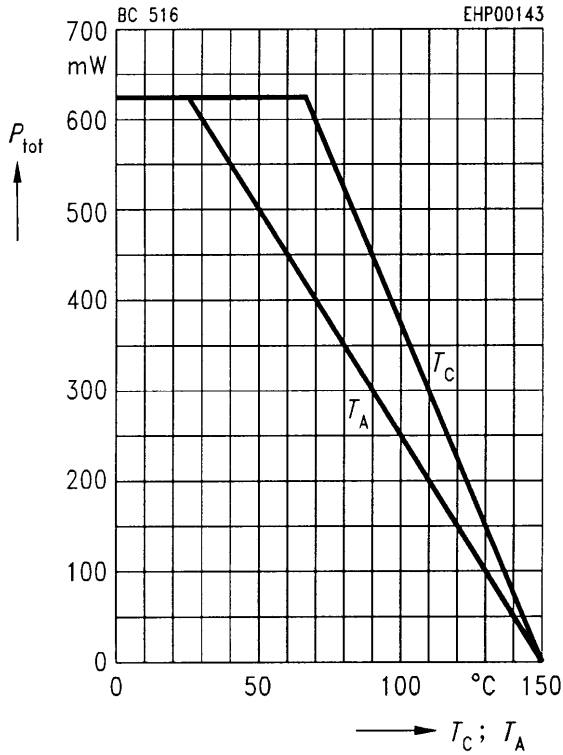

**Collector cutoff current  $I_{CB0} = f(T_A)$**

$V_{CB} = 30 \text{ V}$

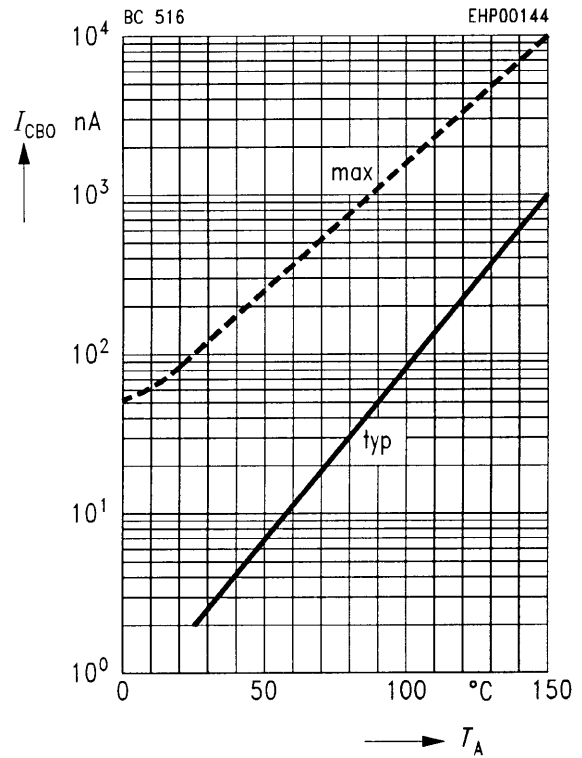

**Permissible pulse load  $R_{thJA} = f(t_p)$**

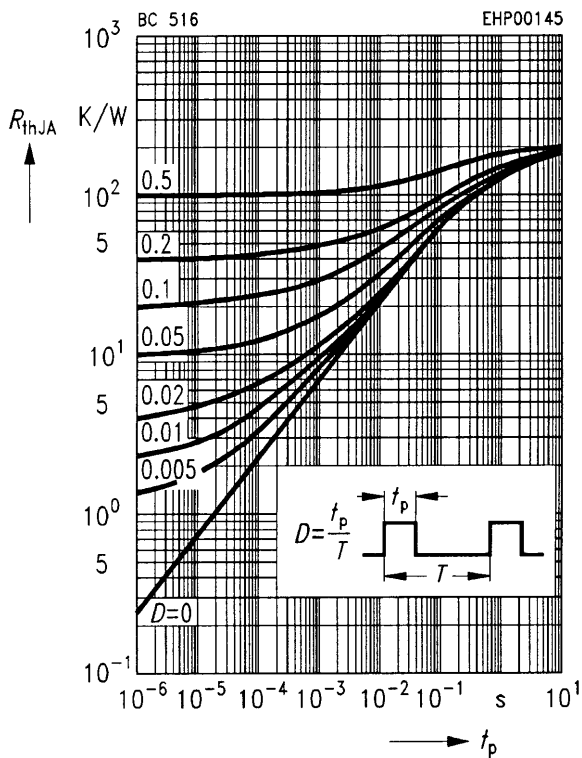

**Transition frequency  $f_T = f(I_C)$**

$V_{CE} = 5 \text{ V}$

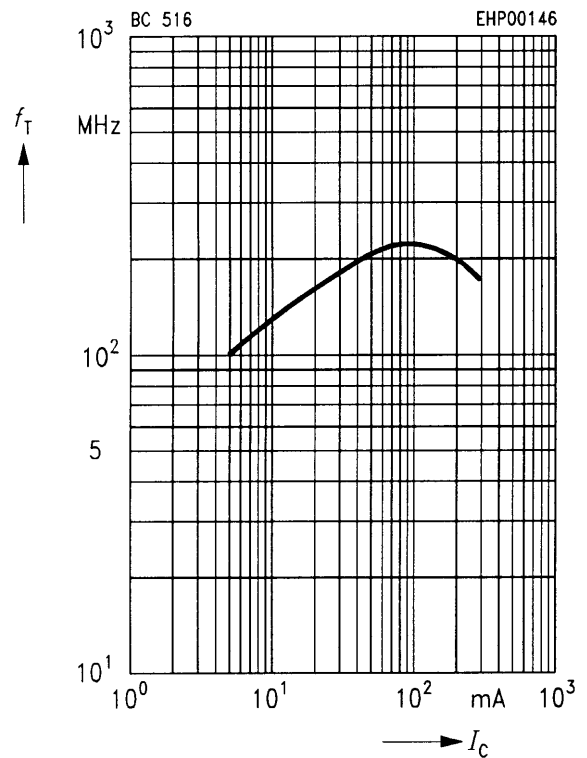

**Collector-emitter saturation voltage**

$I_C = f(V_{CEsat})$

$h_{FE} = 1000$

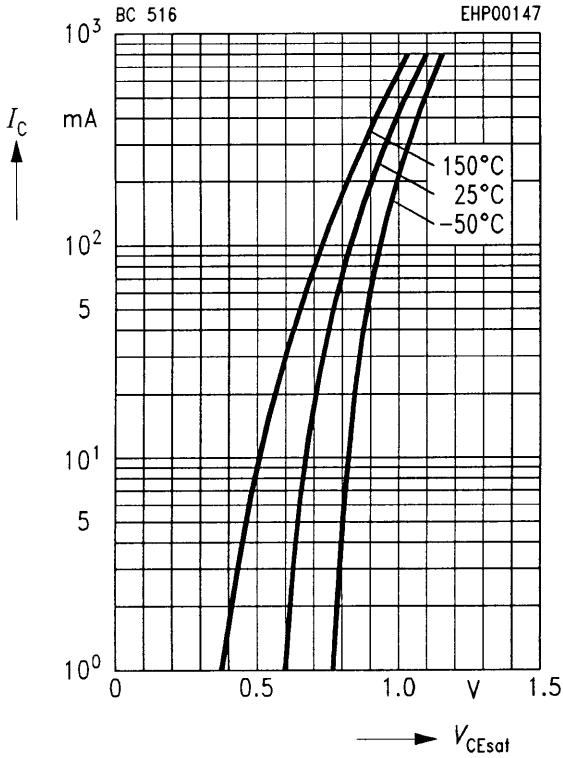

**Base-emitter saturation voltage**

$I_C = f(V_{BEsat})$

$h_{FE} = 1000$

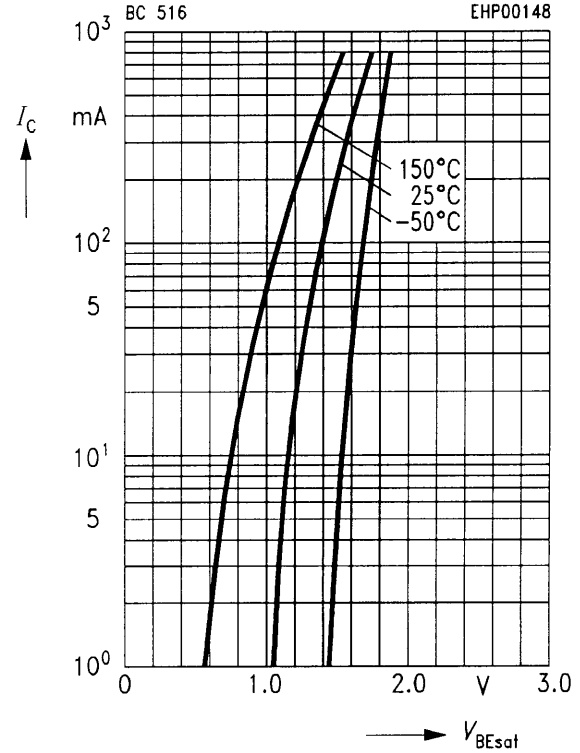

**DC current gain  $h_{FE} = f(I_C)$**

$V_{CE} = 2\text{ V}$

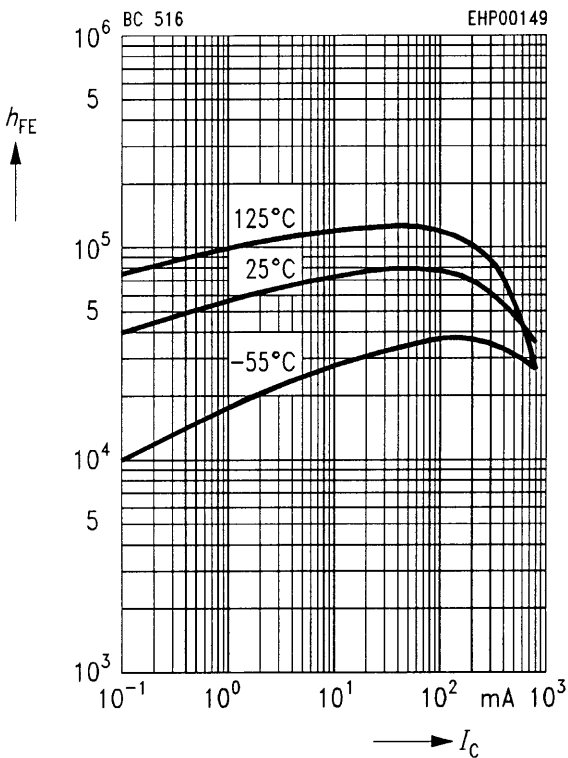

**Capacitance  $C = f(V_{EB}, V_{CB})$**

