

**NPN Silicon Darlington Transistors**

**BD 675**  
**BD 677**  
**BD 679**

SIEMENS AKTIENGESELLSCHAFT 25C 04395 D

**Epibase power darlington transistors (40 W)**

BD 675, BD 677, and BD 679 are monolithic NPN silicon epibase power darlington transistors with diode and resistors in a TO 126 plastic package (12 A 3 DIN 41869, sheet 4). The collectors of the two transistors are electrically connected to the metallic mounting area. These darlington transistors for AF applications are outstanding for particularly high current gain. Together with BD 676, BD 678, and BD 680 they are especially suitable for complementary AF push-pull output stages and color TV correction stages.

Type	Ordering code
BD 675	Q62702-D238
BD 677	Q62702-D240
BD 679	Q62702-D242
BD 675/BD 676 paired	Q62702-D244
BD 677/BD 678 paired	Q62702-D245
BD 679/BD 680 paired	Q62702-D246
Mica washer	Q62902-B62
Spring washer	Q62902-B63
A 3 DIN 137	

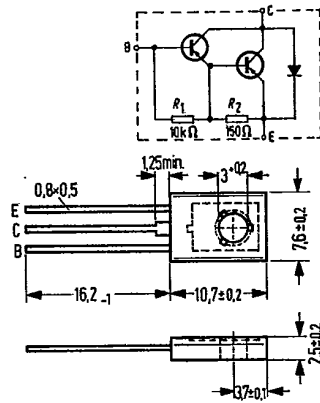

Approx. weight 0.5 g. Dimensions in mm

**Maximum ratings**

	BD 675	BD 677	BD 679		
Collector-emitter voltage	$V_{CE0}$	45	60	80	V
Collector-base voltage	$V_{CB0}$	45	60	80	V
Base-emitter voltage	$V_{EBO}$	5	5	5	V
Collector current	$I_C$	4	4	4	A
Collector-peak current ( $t \leq 1$ ms)	$I_{CM}$	7	7	7	A
Base current	$I_B$	0.1	0.1	0.1	A
Storage temperature	$T_{stg}$		-55 to +150		°C
Junction temperature	$T_j$	150	150	150	°C
Total power dissipation ( $T_{case} \leq 25$ °C; $V_{CE} \leq 20$ V)	$P_{tot}$	40	40	40	W

**Thermal resistance**

Junction to ambient air	$R_{thJA}^{1)}$	<100	<100	<100	K/W
Junction to case	$R_{thJC}$	<3.12	<3.12	<3.12	K/W

1) Transistor fixing with M 3 screw, starting torque  $MA \leq 0.5$  to  $0.8$  Nm. If a  $50 \mu$  mica washer (ungreased) is used, the thermal resistance increases by 8 K/W and in case of a greased one by 4 K/W. Below the screw head, a washer or a spring washer should be used.

SIEMENS AKTIENGESELLSCHAFT

Static characteristics ( $T_{amb} = 25^{\circ}\text{C}$ )

		BD 675	BD 677	BD 679	
Collector cutoff current ( $V_{CB} = V_{CBmax}$ )	$I_{CBO}$	<0.2	<0.2	<0.2	mA
( $V_{BC} = V_{CBmax}$ ; $T_{amb} = 100^{\circ}\text{C}$ )	$I_{CBO}$	<2	<2	<2	mA
Collector cutoff current ( $V_{CE} = 0.5 V_{CEmax}$ )	$I_{CEO}$	<0.5	<0.5	<0.5	mA
Emitter cutoff current ( $V_{EB} = 5 \text{ V}$ )	$I_{EBO}$	<5	<5	<5	mA
Collector-emitter breakdown voltage ( $I_C = 100 \text{ mA}$ ) <sup>1)</sup>	$V_{(BR)CEO}$	>45	>60	>80	V
Collector-base breakdown voltage ( $I_C = 1 \text{ mA}$ )	$V_{(BR)CBO}$	>45	>60	>80	V
Emitter-base breakdown voltage ( $I_E = 5 \text{ mA}$ )	$V_{(BR)EBO}$	>5	>5	>5	V
Collector emitter saturation voltage ( $I_C = 50 \text{ mA}$ ; $V_{CE} = 3 \text{ V}$ )	$h_{FE}$	750	750	750	-
( $I_C = 1.5 \text{ A}$ ; $V_{CE} = 3 \text{ V}$ )	$h_{FE}$	>750	>750 (3000)	>750 (3000)	-
( $I_C = 4 \text{ A}$ ; $V_{CE} = 3 \text{ V}$ )	$h_{FE}$	1000	1000	1000	-
Base-emitter forward voltage ( $I_C = 1.5 \text{ A}$ ; $V_{CE} = 3 \text{ V}$ )	$V_{BE}$	<2.5	<2.5	<2.5	V
Collector-emitter saturation voltage ( $I_C = 1.5 \text{ A}$ ; $I_B = 30 \text{ mA}$ )	$V_{CEsat}$	<2.5	<2.5	<2.5	V
Forward voltage of the protective diode at $I_F = 3 \text{ A}$	$V_F$	1.8	1.8	1.8	V

Dynamic characteristics ( $T_{amb} = 25^{\circ}\text{C}$ )

Transition frequency ( $I_C = 1.5 \text{ A}$ ; $V_{CE} = 3 \text{ V}$ ; $f = 1 \text{ MHz}$ )	$f_T$	7 (>1)	7 (>1)	7 (>1)	MHz
Cutoff frequency in common emitter configuration ( $I_C = 1.5 \text{ A}$ ; $V_{CE} = 3 \text{ V}$ )	$f_{hfe}$	60	60	60	kHz

<sup>1)</sup>  $t = 200 \mu\text{s}$ , duty cycle 1%.

SIEMENS AKTIENGESELLSCHAFT

BD 675  
 BD 677  
 BD 679

Total perm. power dissipation  
 versus temperature  
 $P_{tot} = f(T_{case}); V_{CE} = \text{parameter}$

BD 675, BD 677

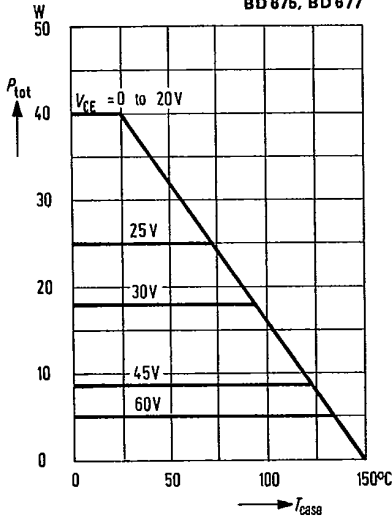

Total perm. power dissipation  
 versus temperature  
 $P_{tot} = f(T_{case}); V_{CE} = \text{parameter}$

BD 679

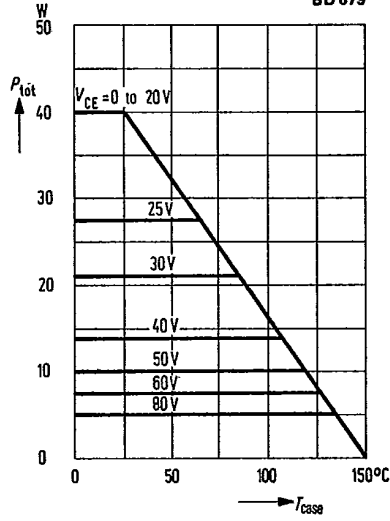

Permissible operating range  
 $I_C = f(V_{CE}); v = 0.01; T_{case} = 25^\circ\text{C}$

BD 675, BD 677

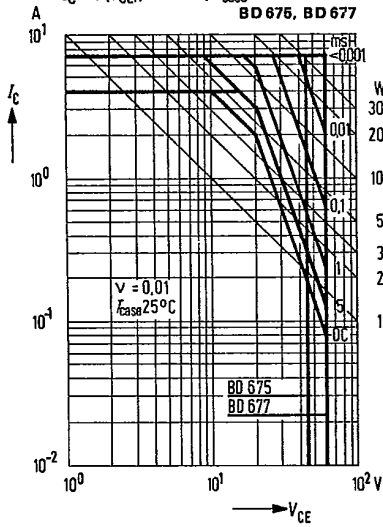

Permissible operating range  
 $I_C = f(V_{CE}); v = 0.01; T_{case} = 25^\circ\text{C}$

BD 679

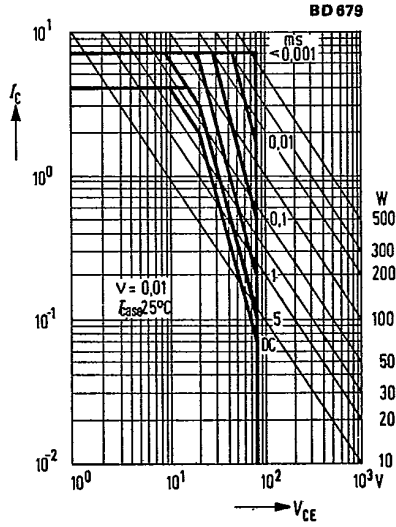

BD 675  
 BD 677  
 BD 679

SIEMENS AKTIENGESELLSCHAFT

Permissible pulse load  
 $P_{thJC} = f(t)$ ;  $v =$  parameter  
 BD 675, BD 677, BD 679

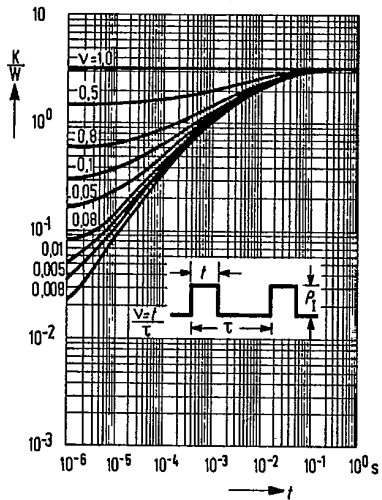

DC current gain  $h_{FE} = f(I_C)$   
 $-V_{CE} = 3V$   
 BD 675, BD 677, BD 679

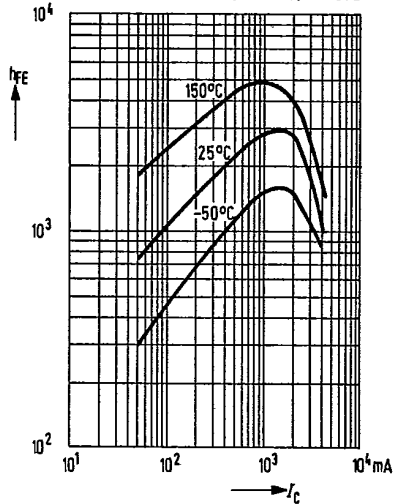

Collector current  $I_C = f(V_{BE})$   
 $-V_{CE} = 3V; T_{case} = 25^\circ C$   
 BD 675, BD 677, BD 679

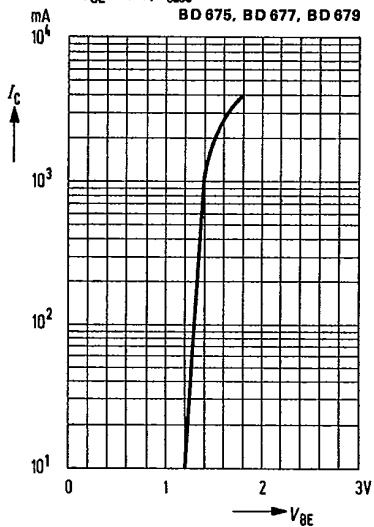

Collector-emitter saturation voltage  
 $V_{CEsat} = f(I_C); h_{FE} = 100; T_{case} = 25^\circ C$   
 BD 675, BD 677, BD 679

