

Hyper Multi TOPLED® Hyper-Bright LED

LSY T676

Besondere Merkmale

- Gehäusebauform: P-LCC-4
- Gehäusefarbe: weiß
- als optischer Indikator einsetzbar
- zur Hinterleuchtung, Lichtleiter- und Linseneinkopplung
- beide Leuchtdiodenchips getrennt ansteuerbar
- hohe Signalwirkung durch Farbwechsel der LED möglich
- bei geeigneter Ansteuerung, Farbwechsel von grün über gelb und orange bis super-rot möglich
- für alle SMT-Bestück- und Löttechniken geeignet
- gegurtet (8-mm-Filmgurt)
- Störimpulsfest nach DIN 40839

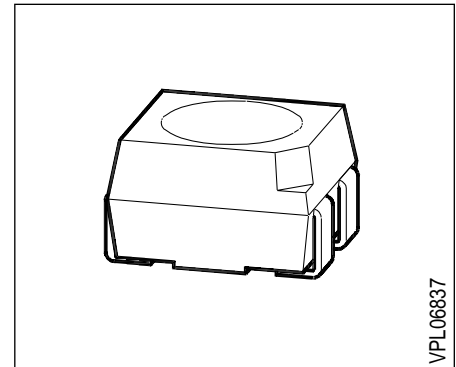

Features

- P-LCC-4 package
- color of package: white
- for use as optical indicator
- for backlighting, optical coupling into light pipes and lenses
- both chips can be controlled separately
- high signal efficiency possible by color change of the LED
- with appropriate controlling it is possible to change color from green to yellow and orange to super-red
- suitable for all SMT assembly and soldering methods
- available taped on reel (8 mm tape)
- load dump resistant acc. to DIN 40839

Typ	Emissionsfarbe	Farbe der Lichtaustrittsfläche	Lichtstärke		Bestellnummer
Type	Color of Emission	Color of the Light Emitting Area	Luminous Intensity $I_F = 20 \text{ mA}$ $I_V(\text{mcd})$		Ordering Code
			super-red	yellow	
LSY T676	super-red / yellow	colorless clear	≥ 40	≥ 40	Q62703-Q3428
LSY T676-P+P			40 ... 80	40 ... 80	
LSY T676-P+Q			40 ... 80	63 ... 125	
LSY T676-P+R			40 ... 80	100... 200	
LSY T676-Q+Q			63 ... 125	63 ... 125	
LSY T676-Q+R			63 ... 125	100... 200	

Grenzwerte Maximum Ratings

Bezeichnung Parameter	Symbol Symbol	Wert Value		Einheit Unit
		LS	LY	
Betriebstemperatur Operating temperature range	T_{op}	– 55 ... + 100		°C
Lagertemperatur Storage temperature range	T_{stg}	– 55 ... + 100		°C
Sperrschichttemperatur Junction temperature	T_j	+ 100		°C
Durchlaßstrom Forward current	I_F	30	20	mA
Stoßstrom Surge current $t \leq 10 \mu s, D = 0.005$	I_{FM}	to be defined		A
Sperrspannung Reverse voltage	V_R	3		V
Verlustleistung Power dissipation	P_{tot}	80	55	mW
Wärmewiderstand Thermal resistance Sperrschicht / Umgebung Junction / air				
Montage auf PC-Board*) (Padgröße $\geq 16 \text{ mm}^2$) mounted on PC board*) (pad size $\geq 16 \text{ mm}^2$)	$R_{th JA}^{1)}$ $R_{th JA}^{2)}$	500 600		K/W K/W

*) PC-board: FR4

1) nur ein Chip betrieben

1) one system only

2) beide Chips betrieben

2) both systems on simultaneously

Notes

Die angegebenen Grenzdaten gelten für einen Chip.

The stated maximum ratings refer to one chip.

Kennwerte ($T_A = 25 \text{ }^\circ\text{C}$)

Characteristics

Bezeichnung Parameter	Symbol Symbol	Wert Value		Ein- heit Unit
		LS	LY	
Wellenlänge des emittierten Lichtes Wavelength at peak emission $I_F = 10 \text{ mA}$	(typ.) λ_{peak} (typ.)	645	591	nm
Dominantwellenlänge Dominant wavelength $I_F = 10 \text{ mA}$	(typ.) λ_{dom} (typ.)	630	587	nm
Spektrale Bandbreite bei 50 % $I_{\text{rel max}}$ Spectral bandwidth at 50 % $I_{\text{rel max}}$ $I_F = 10 \text{ mA}$	(typ.) $\Delta\lambda$ (typ.)	16	15	nm
Abstrahlwinkel bei 50 % I_V (Vollwinkel) Viewing angle at 50 % I_V	2ϕ	120	120	Grad deg.
Durchlaßspannung Forward voltage $I_F = 20 \text{ mA}$	(typ.) V_F (max.) V_F	2.0 2.6	2.0 2.6	V V
Sperrstrom Reverse current $V_R = 3 \text{ V}$	(typ.) I_R (max.) I_R	0.01 10	0.01 10	μA μA
Temperaturkoeffizient von λ_{dom} ($I_F = 20 \text{ mA}$) Temperature coefficient of λ_{dom} ($I_F = 20 \text{ mA}$)	TC_λ	0.014	0.096	nm/K
Temperaturkoeffizient von λ_{peak} , $I_F = 20 \text{ mA}$ Temperature coefficient of λ_{peak} , $I_F = 20 \text{ mA}$	(typ.) TC_λ (typ.)	0.14	0.13	nm/K
Temperaturkoeffizient von V_F , $I_F = 20 \text{ mA}$ Temperature coefficient of V_F , $I_F = 20 \text{ mA}$	(typ.) TC_V (typ.)	- 1.95	- 2.51	mV/K

Relative spektrale Emission $I_{rel} = f(\lambda)$, $T_A = 25\text{ °C}$, $I_F = 10\text{ mA}$

Relative spectral emission

$V(\lambda)$ = spektrale Augenempfindlichkeit

Standard eye response curve

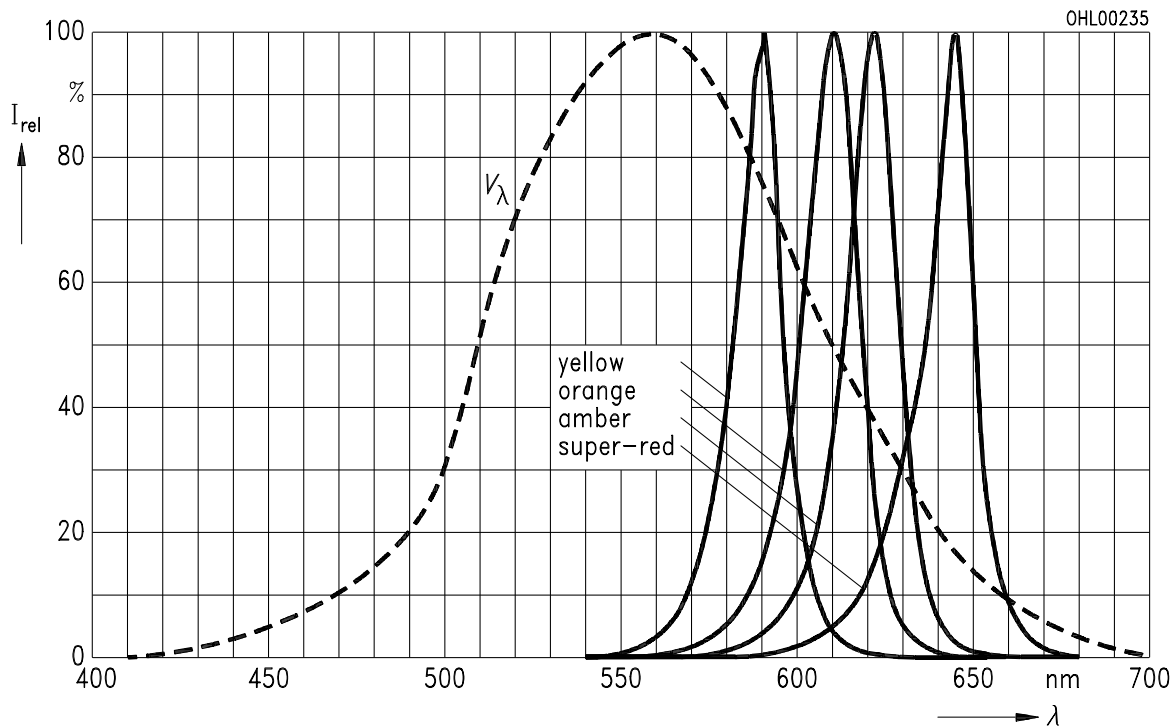

Abstrahlcharakteristik $I_{rel} = f(\varphi)$

Radiation characteristic

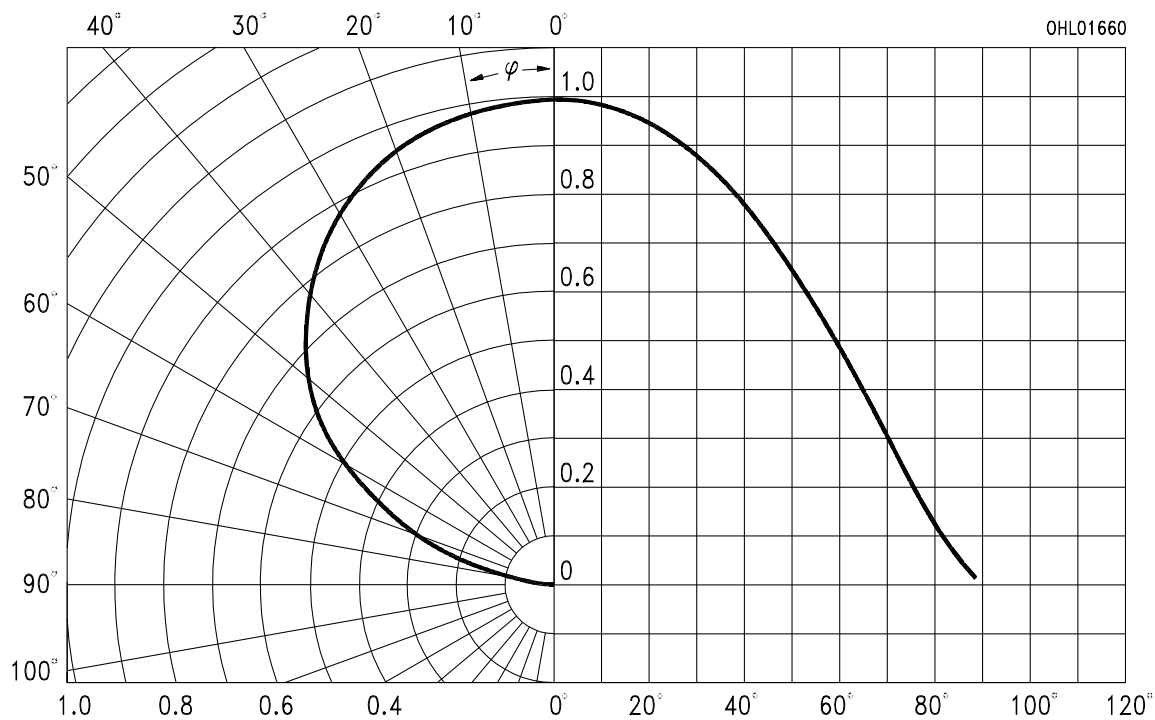

Durchlaßstrom $I_F = f(V_F)$

Forward current

$T_A = 25\text{ °C}$

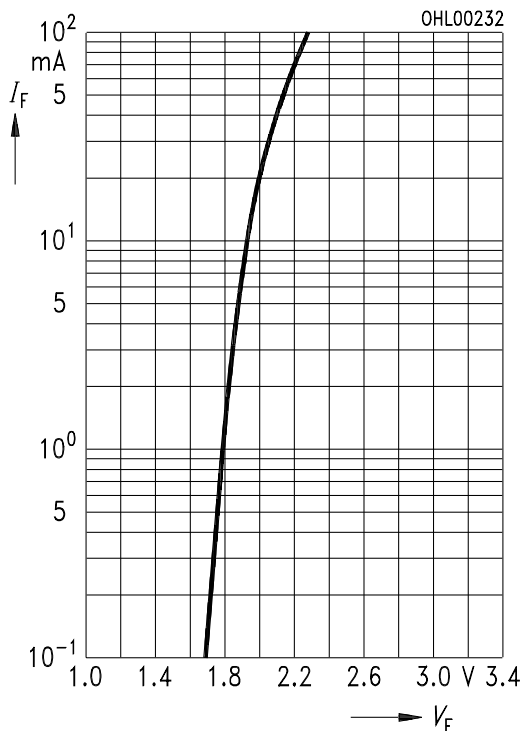

Maximal zulässiger Durchlaßstrom $I_F = f(T_A)$

Max. permissible forward current

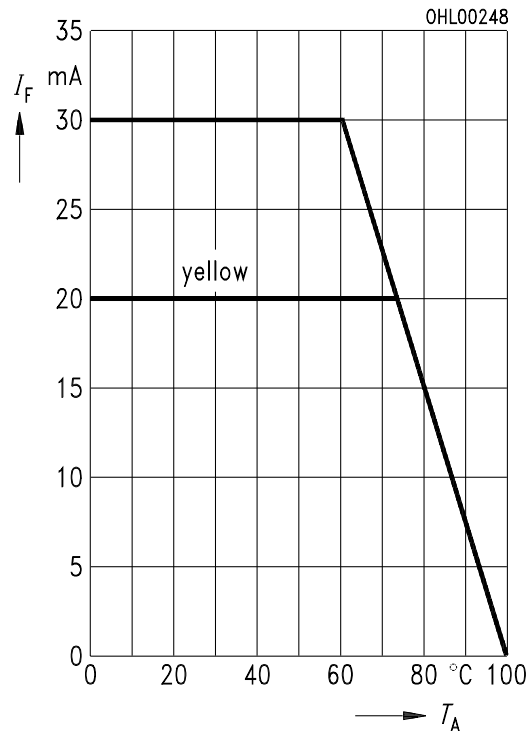

Relative Lichtstärke $I_V / I_{V(20\text{ mA})} = f(I_F)$

Relative luminous intensity

$T_A = 25\text{ °C}$

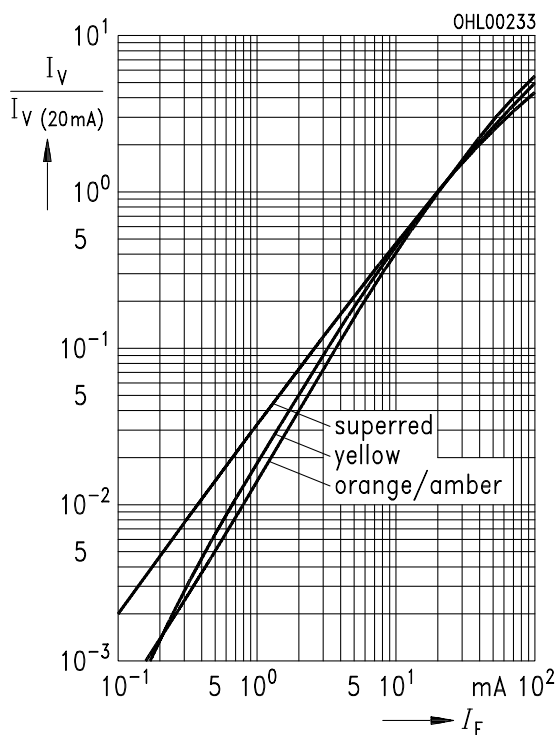

Zulässige Impulsbelastbarkeit $I_f = f(t_p)$

Permissible pulse handling capability

$D = \text{Parameter}; T_A = 25\text{ °C}$

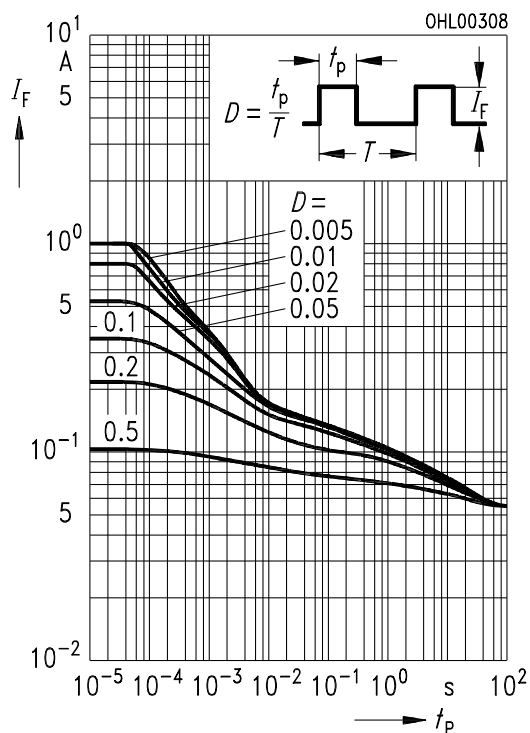

Relative Lichtstärke $I_V / I_{V(25^\circ\text{C})} = f(T_A)$

Relative luminous intensity

$I_F = 10 \text{ mA}$

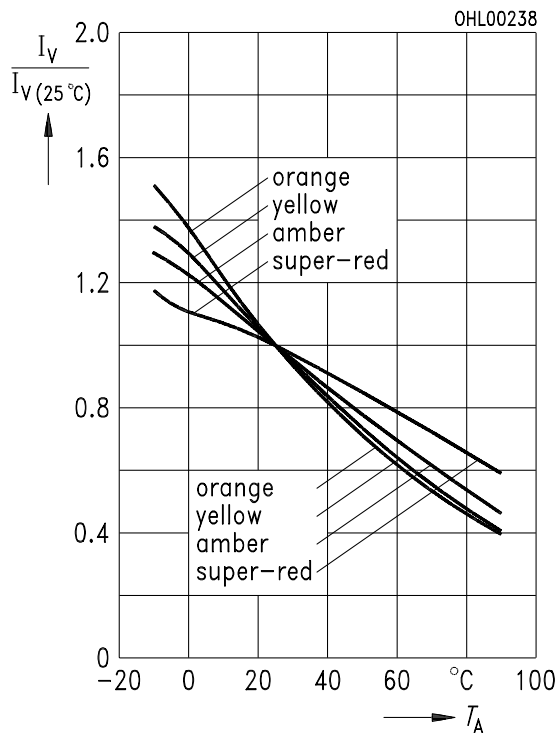

Maßzeichnung

(Maße in mm, wenn nicht anders angegeben)

Package Outlines

(Dimensions in mm, unless otherwise specified)

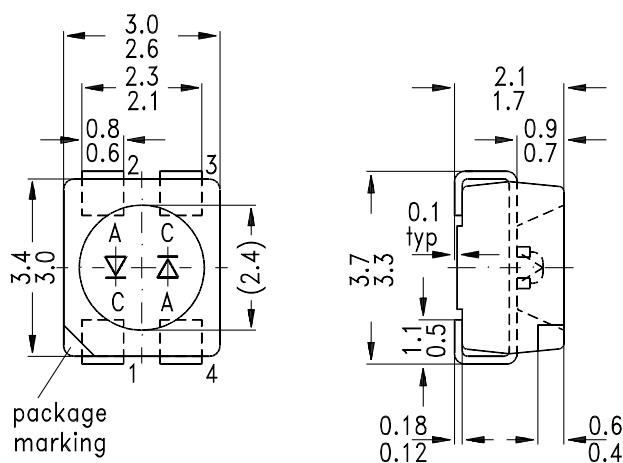

L	S	Y	T676
LED	Emission color 1	Emission color 2	Package
	cathode: pin 1	cathode: pin 3	

GPL06837