

## NPN Silicon AF Transistors

**BC 635**  
**... BC 639**

- High current gain
- High collector current
- Low collector-emitter saturation voltage
- Complementary types: BC 636, BC 638,  
BC 640 (PNP)

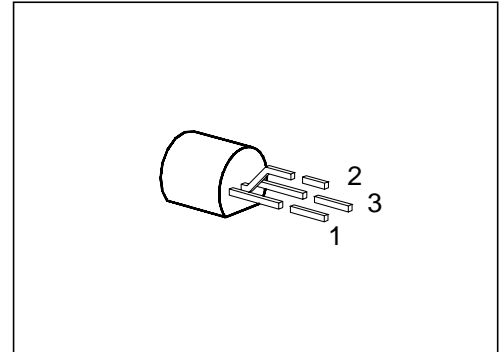

Type	Marking	Ordering Code	Pin Configuration			Package <sup>1)</sup>
			1	2	3	
BC 635 BC 637 BC 639	—	Q68000-A3360 Q68000-A2285 Q68000-A3361	E	C	B	TO-92

If desired, selected transistors, type BC 63 ★ -10 ( $h_{FE} = 63 \dots 160$ ), or BC 63 ★ -16 ( $h_{FE} = 100 \dots 250$ ) are available. Ordering codes upon request.

<sup>1)</sup> For detailed information see chapter Package Outlines.

## Maximum Ratings

Parameter	Symbol	Values			Unit
		BC 635	BC 637	BC 639	
Collector-emitter voltage	$V_{CE0}$	45	60	80	V
Collector-base voltage	$V_{CB0}$	45	60	100	
Emitter-base voltage	$V_{EB0}$	5			
Collector current	$I_C$	1			A
Peak collector current	$I_{CM}$	1.5			
Base current	$I_B$	100			mA
Peak base current	$I_{BM}$	200			
Total power dissipation, $T_C = 90\text{ °C}^{1)}$	$P_{tot}$	0.8 (1)			W
Junction temperature	$T_j$	150			
Storage temperature range	$T_{stg}$	- 65 ... + 150			°C

## Thermal Resistance

Junction - ambient <sup>1)</sup>	$R_{th\ JA}$	≤ 156	K/W
Junction - case <sup>2)</sup>	$R_{th\ JC}$	≤ 75	

1) If the transistors with max. 4 mm lead length are fixed on PCBs with a min. 10 mm × 10 mm large copper area for the collector terminal,  $R_{th\ JA} = 125\text{ K/W}$  and thus  $P_{tot\ max} = 1\text{ W}$  at  $T_A = 25\text{ °C}$ .

2) Mounted on Al heat sink 15 mm × 25 mm × 0.5 mm.

## Electrical Characteristics

at  $T_A = 25\text{ °C}$ , unless otherwise specified.

Parameter	Symbol	Values			Unit
		min.	typ.	max.	

### DC characteristics

Collector-emitter breakdown voltage $I_C = 10\text{ mA}$	$V_{(BR)CE0}$				V
BC 635		45	–	–	
BC 637		60	–	–	
BC 639		80	–	–	
Collector-base breakdown voltage $I_C = 100\text{ }\mu\text{A}$	$V_{(BR)CB0}$				
BC 635		45	–	–	
BC 637		60	–	–	
BC 639		100	–	–	
Emitter-base breakdown voltage $I_E = 10\text{ }\mu\text{A}$	$V_{(BR)EB0}$	5	–	–	
Collector cutoff current $V_{CB} = 30\text{ V}$ $V_{CB} = 30\text{ V}, T_A = 150\text{ °C}$	$I_{CB0}$	–	–	100 20	nA $\mu\text{A}$
Emitter cutoff current $V_{EB} = 4\text{ V}$	$I_{EB0}$	–	–	100	nA
DC current gain $I_C = 5\text{ mA}; V_{CE} = 2\text{ V}$ $I_C = 150\text{ mA}; V_{CE} = 2\text{ V}^1)$ $I_C = 500\text{ mA}; V_{CE} = 2\text{ V}^1)$	$h_{FE}$	25 40 25	– – –	– 250 –	–
Collector-emitter saturation voltage <sup>1)</sup> $I_C = 500\text{ mA}; I_B = 50\text{ mA}$	$V_{CEsat}$	–	–	500	mV
Base-emitter voltage <sup>1)</sup> $I_C = 500\text{ mA}; V_{CE} = 2\text{ V}$	$V_{BE}$	–	–	1	V

### AC characteristics

Transition frequency $I_C = 50\text{ mA}, V_{CE} = 10\text{ V}, f = 20\text{ MHz}$	$f_T$	–	100	–	MHz
---	-------	---	-----	---	-----

<sup>1)</sup> Pulse test:  $t \leq 300\text{ }\mu\text{s}, D \leq 2\text{ %}$ .

**Total power dissipation**  $P_{tot} = f(T_A; T_C)$

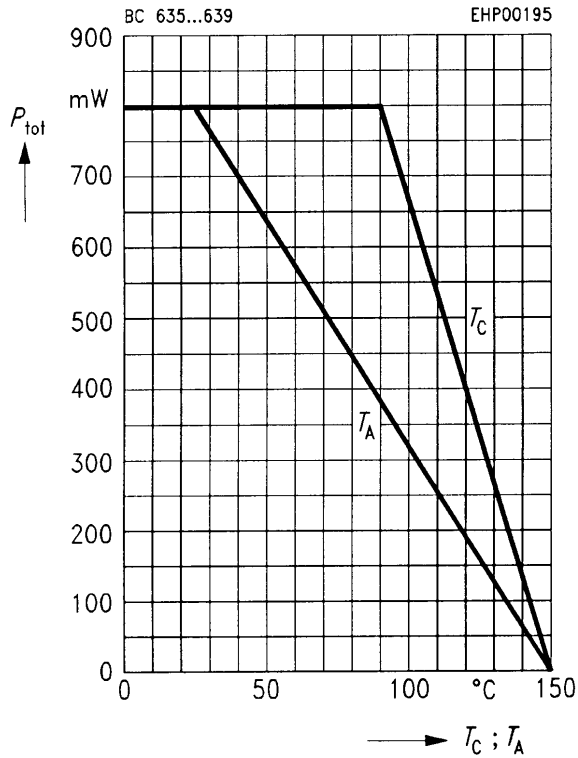

**Collector cutoff current**  $I_{CB0} = f(T_A)$   
 $V_{CB} = 30 V$

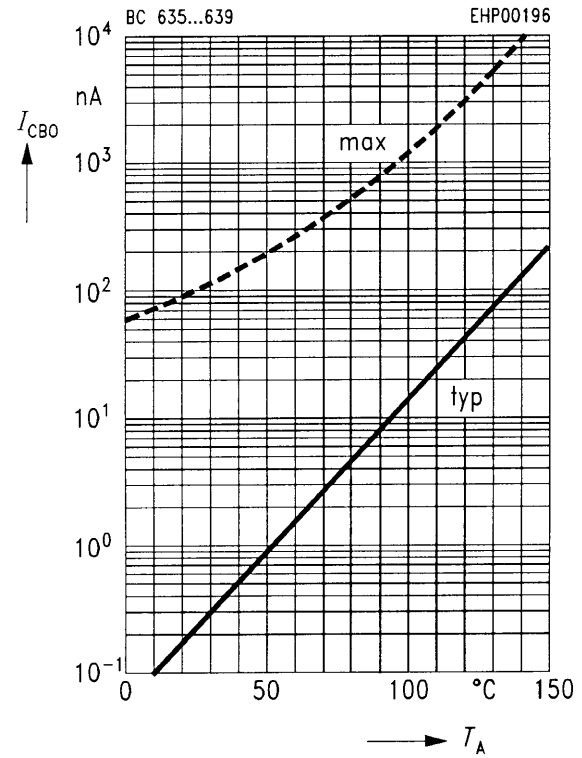

**Permissible pulse load**  $R_{thJA} = f(t_p)$   
 $V_{CE} = 2 V$

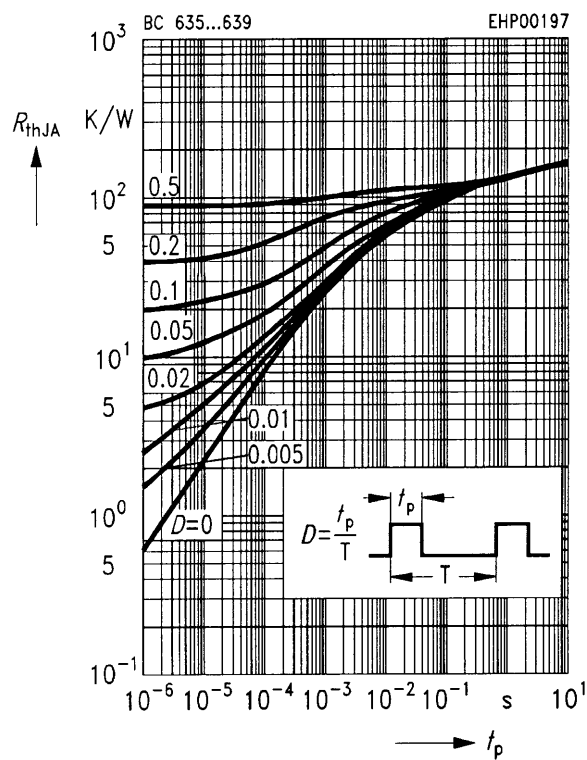

**Collector current**  $I_C = f(V_{BE})$

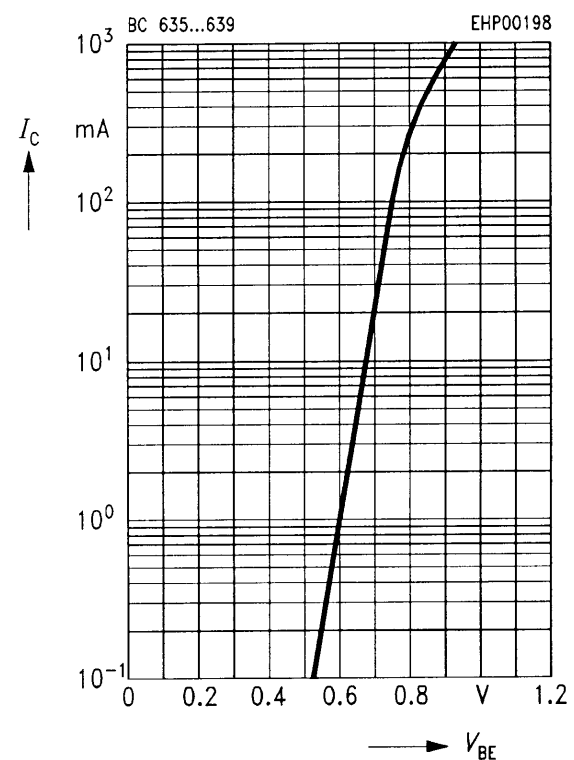

**DC current gain  $h_{FE} = f(I_C)$**

$V_{CE} = 2 \text{ V}$

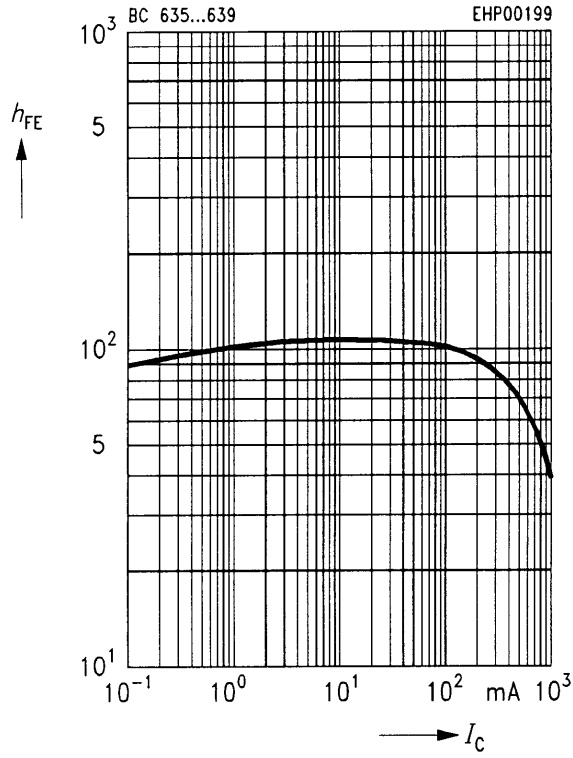

**Collector-emitter saturation voltage  $V_{CEsat} = f(I_C)$**

$V_{CEsat} = f(I_C)$

$h_{FE} = 10$

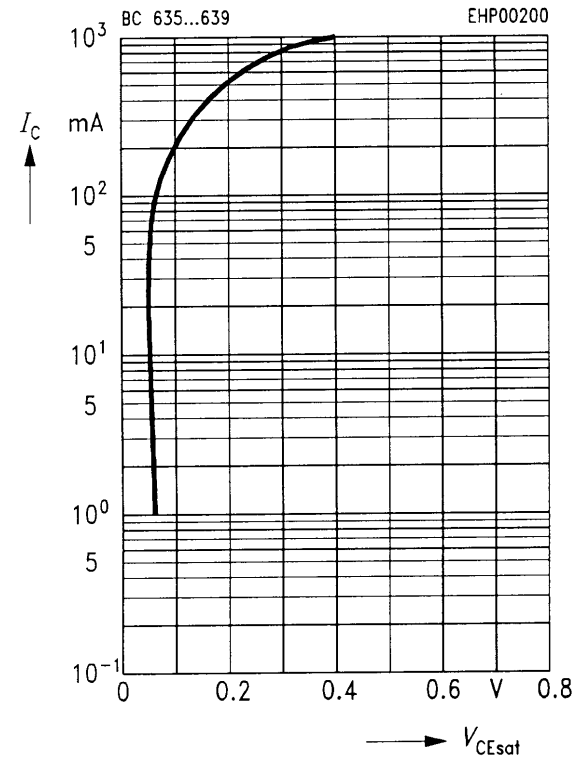

**Transition frequency  $f_T = f(I_C)$**

$V_{CE} = 10 \text{ V}, f = 20 \text{ MHz}$

