

Datasheet

- * Power amplifier for DECT and PCS application
- * Fully integrated 3 stage amplifier
- * Operating voltage range: 2.7 to 6 V
- * Overall power added efficiency 35 %
- * Input matched to 50 Ω , simple output match

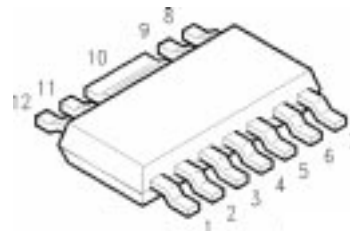

ESD: **E**lectrostatic **d**ischarge sensitive device,
observe handling precautions!

Type	Marking	Ordering code (taped)	Package 1)
CGY 180	CGY 180	Q68000-A8882	MW 12

Maximum ratings

Characteristics	Symbol	max. Value	Unit
Positive supply voltage	V_D	8	V
Negative supply voltage ²⁾	V_G	-8	V
Supply current	I_D	1.2	A
Maximum input power	$P_{in,max}$	10	dBm
Channel temperature	T_{Ch}	150	$^{\circ}\text{C}$
Storage temperature	T_{stg}	-55...+150	$^{\circ}\text{C}$
Total power dissipation ($T_s \leq 81^{\circ}\text{C}$) <i>T_s: Temperature at soldering point</i>	P_{tot}	2.3	W
Pulse peak power	P_{Pulse}	9.5	W

Thermal Resistance

Channel-soldering point	R_{thChS}	≤ 30	K/W
-------------------------	-------------	-----------	-----

1) Plastic body identical to SOT 223, dimensions see chapter Package Outlines

2) $V_G = -8\text{V}$ only in combination with $V_{TR} = 0\text{V}$; $V_G = -6\text{V}$ while $V_{TR} \neq 0\text{V}$

Functional Block Diagram:

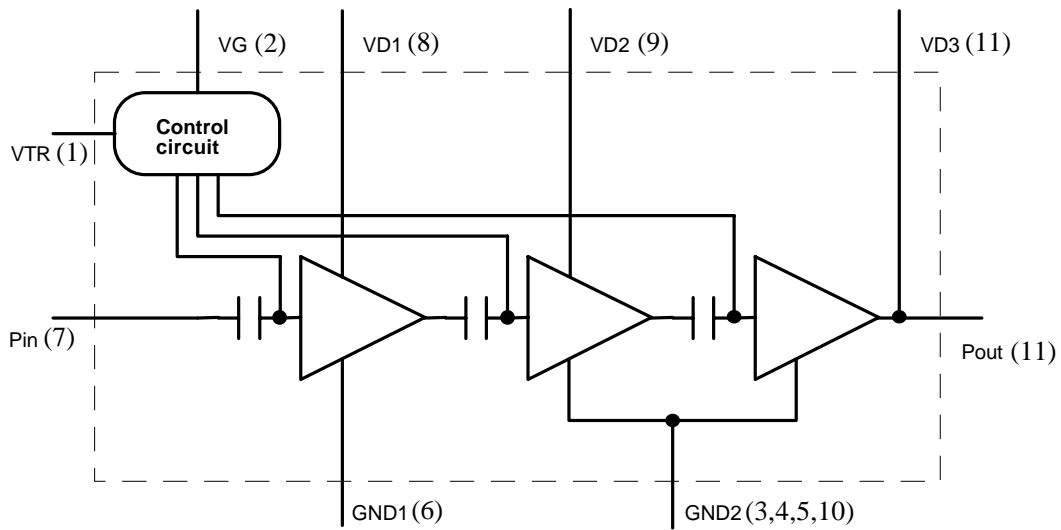

Pin #	Configuration
1	VTR Control voltage for transmit (0V) / receive (open) mode
2	VG Negative voltage at control circuit (-4V...-8V)
3	GND2 RF and DC ground of the 2nd and 3rd stage
4	GND2 RF and DC ground of the 2nd and 3rd stage
5	GND2 RF and DC ground of the 2nd and 3rd stage
6	GND1 RF and DC ground of the 1st stage
7	RFIn RF input power
8	VD1 Pos. drain voltage of the 1st stage
9	VD2 Pos. drain voltage of the 2nd stage
10	GND2 RF and DC ground of the 2nd and 3rd stage
11	VD3, Pout Pos. drain voltage of the 3rd stage, RF output power
12	n.c.

Control circuit:

VG supply: Negative voltage (stabilization is not necessary) in the range of -4V...-8V.

VTR supply: During transmit operation: 0V., negative supply current 1mA...2.5mA.

During receive operation: not connected (shut off mode)

The operation current I_D of CGY 180 is adjusted by the internal control circuit.

DC characteristics

Characteristics	Symbol	Conditions	min	typ	max	Unit	
Drain current	stage 1	$V_D=3V, V_G=0V, V_{TR} \text{ n.c.}$	150	220	320	mA	
	stage 2						I_{DSS2}
	stage 3						I_{DSS3}
Drain current with active current control	I_D	$V_D=3V, V_G=-4V, V_{TR}=0V$	290	450	650	mA	
Transconductance (stage 1 - 3)	g_{fs1}	$V_D=3V, I_D=90mA$	80	100	140	mS	
	g_{fs2}	$V_D=3V, I_D=90mA$	80	100	140	mS	
	g_{fs3}	$V_D=3V, I_D=400mA$	360	500	630	mS	
Pinch off voltage	V_p	$V_D=3V, I_D < 170\mu A$ (all stages)	-3.8	-2.8	-1.8	V	

Electrical characteristics

($T_A = 25^\circ\text{C}$, $f=1.89\text{ GHz}$, $Z_S=Z_L=50\text{ Ohm}$, $V_D=3.0\text{V}$, $V_G=-4\text{V}$, VTR pin connected to ground, unless otherwise specified)

Characteristics	Symbol	min	typ	max	Unit	
Supply current <i>P_{in} = 0 dBm</i>	I_{DD}	-	450	-	mA	
Negative supply current <i>(transmit operation)</i>	I_G	-	1	2.5	mA	
Shut-off current <i>VTR n.c.</i>	I_D	-	50	180	μA	
Negative supply current <i>(shut off mode, VTR pin n.c.)</i>	I_G	-	10	50	μA	
Gain <i>P_{in} = -20dBm</i>	G	28	30	-	dB	
Output Power <i>P_{in} = 0 dBm</i>	P_O	25.5	27	-	dBm	
Output Power <i>V_D=5V; P_{in} = 0 dBm</i>	P_O	-	30	-	dBm	
Overall Power added Efficiency <i>P_{in} = 0 dBm</i>	η	30	35	-	%	
Harmonics (<i>P_{in} = 0dBm</i>) <i>V_D=3V; (P_{out} = 27dBm)</i>	$2f_0$	-	-	-	-28	dBc
	$3f_0$	-	-	-	-25	
Harmonics (<i>P_{in} = 0dBm</i>) <i>V_D=5V; (P_{out} = 30dBm)</i>	$2f_0$	-	-	-	-25	dBc
	$3f_0$	-	-	-	-22	
Input VSWR <i>V_D=3V;</i>	-	-	2 : 1	2.5 : 1	-	
Third order intercept point <i>V_D=3V; pulsed with a duty cycle of 10%; f₁=1.8900GHz; f₂=1.891728GHz;</i>	IP_3	-	33.5	-	dBm	
Third order intercept point <i>V_D=4.8V; pulsed with a duty cycle of 10%; f₁=1.8900GHz; f₂=1.891728GHz;</i>	IP_3	-	38.5	-	dBm	
Load mismatch <i>P_{in}=0dBm, V_D≤6V, Z_S=50 Ohm, Load VSWR = 20:1 for all phase, VTR=0V, V_G=-4V</i>	-	No module damage for 10 sec.			-	
Stability <i>P_{in}=0dBm, V_D=2-7V, Z_S=50 Ohm, Load VSWR = 3:1 for all phase, VTR=0V, V_G=-4V</i>	-	All spurious output more than 60 dB below desired signal level			-	

DC - characteristics

Input characteristics - typical measured values of stage 1 and 2 , VD1 or VD2=3V

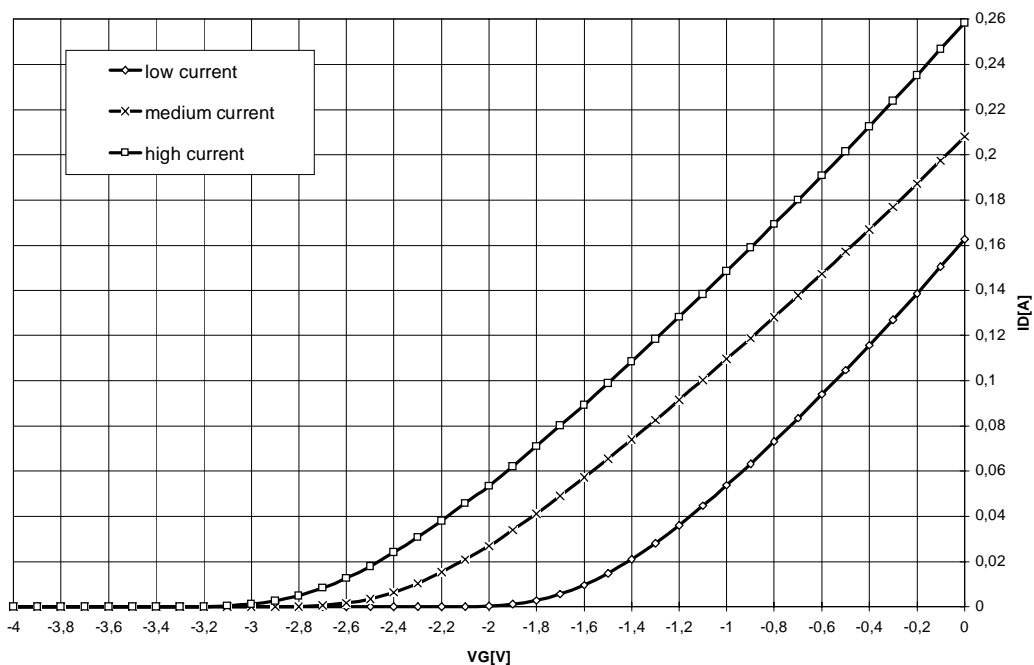

Output characteristics - typical measured values of stage 1 and 2

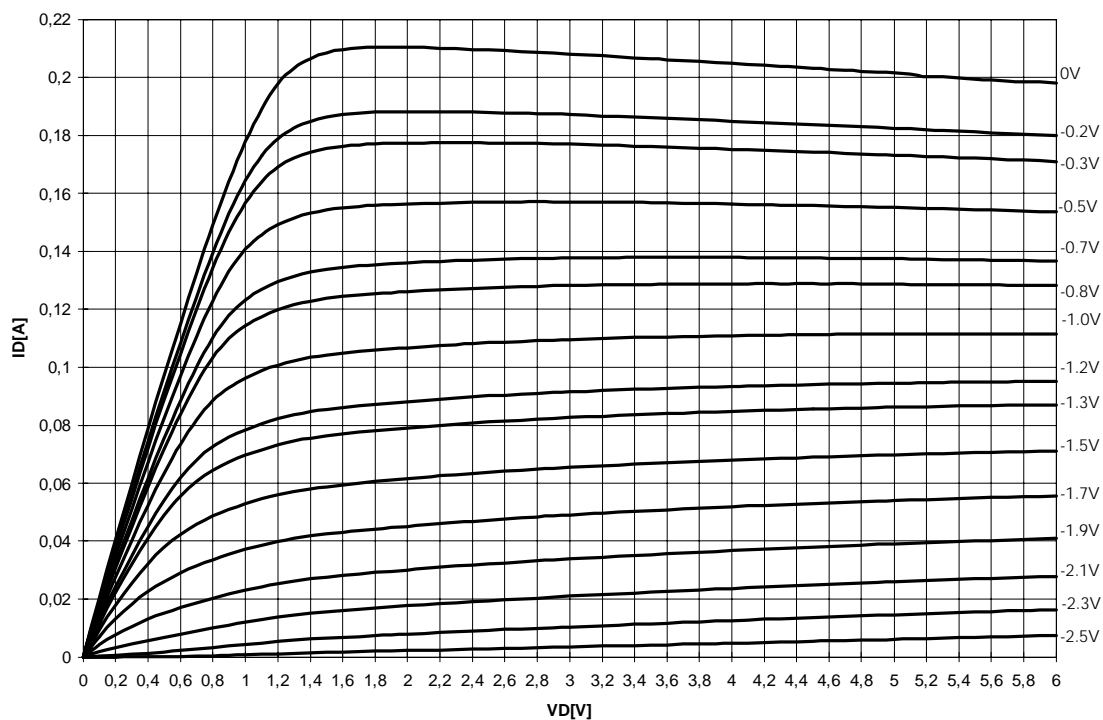

Input characteristics - typical measured values of stage 3, VD3 = 3V

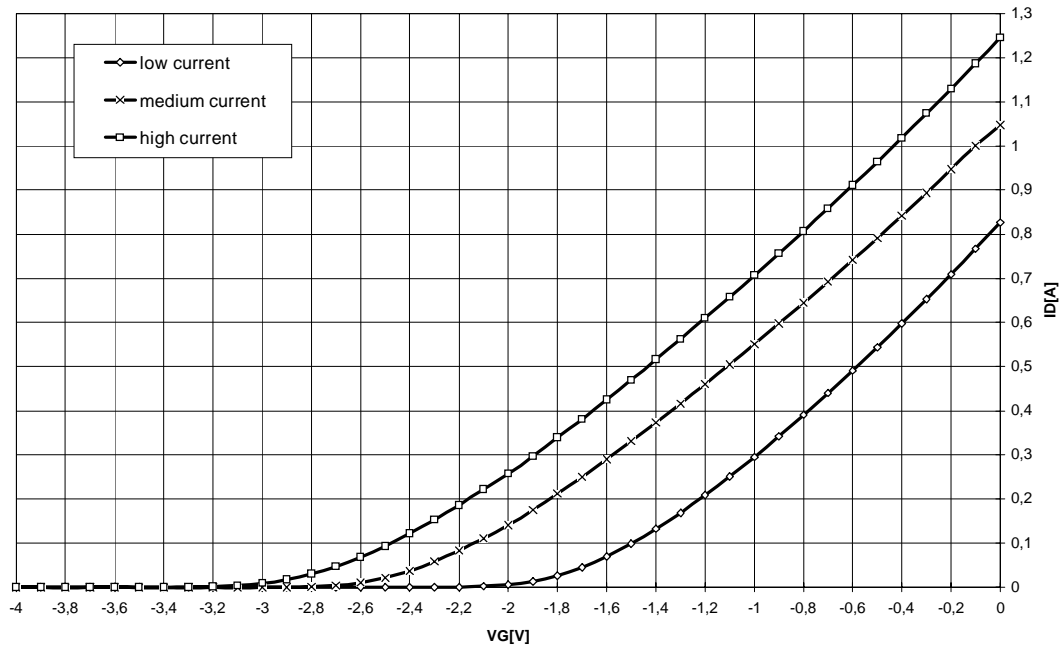

Output characteristics - typical measured values of stage 3

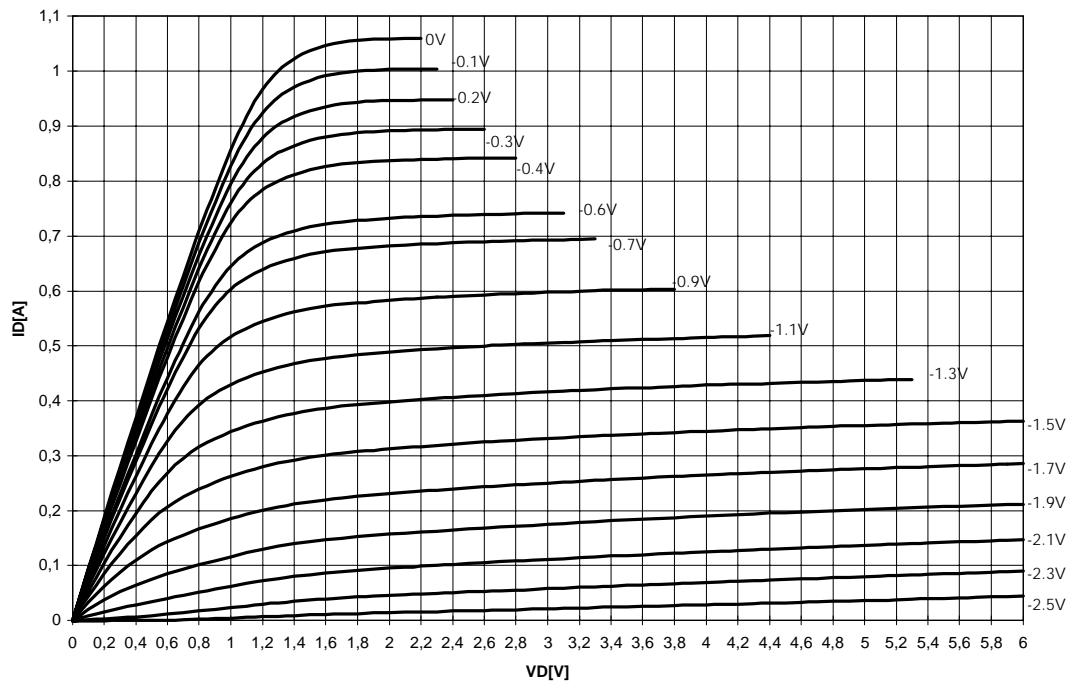

Output power and power added efficiency

pulsed mode: ton=1ms, duty cycle 10%

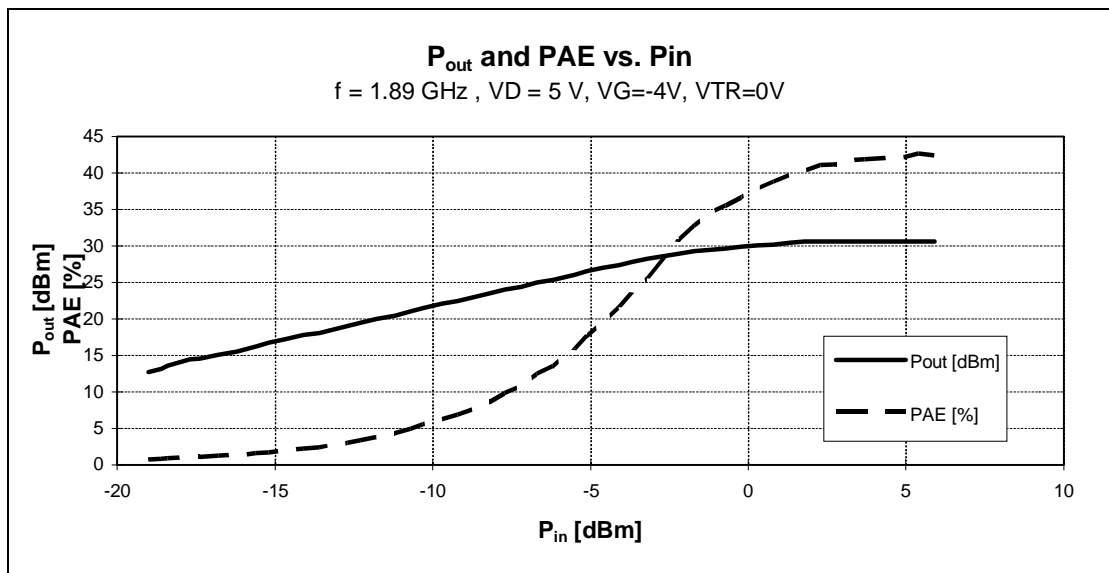
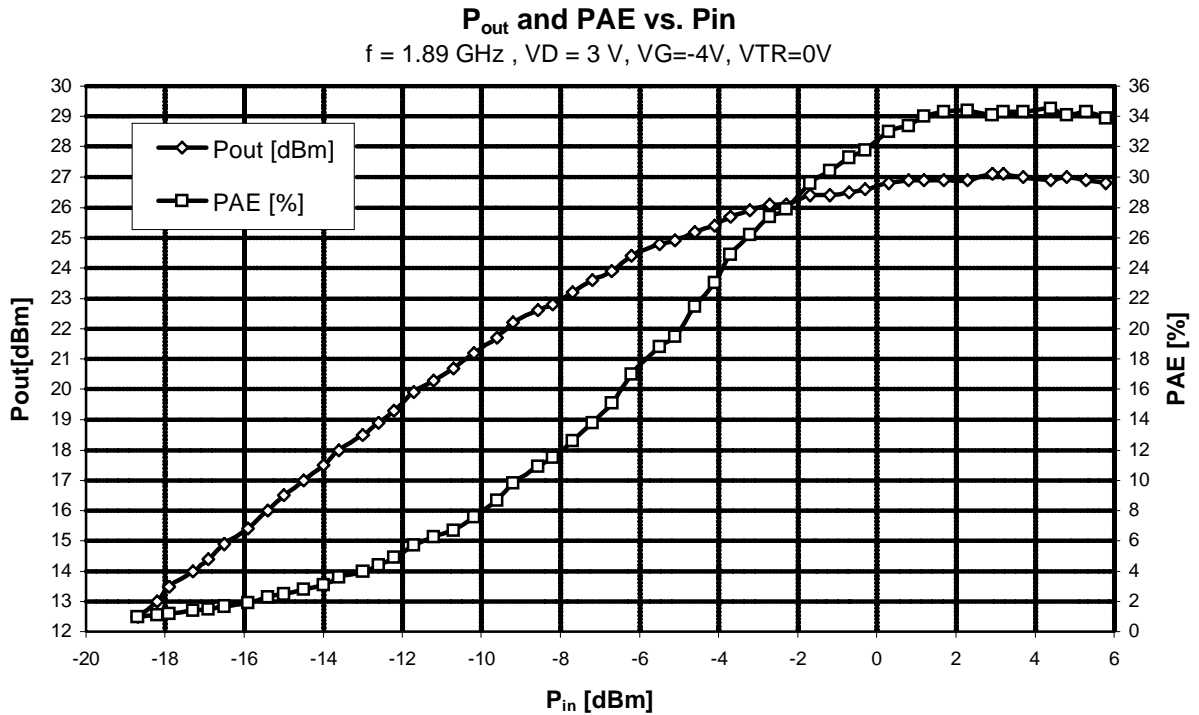

Gain vs. frequency

VG=-4V, VTR=0V

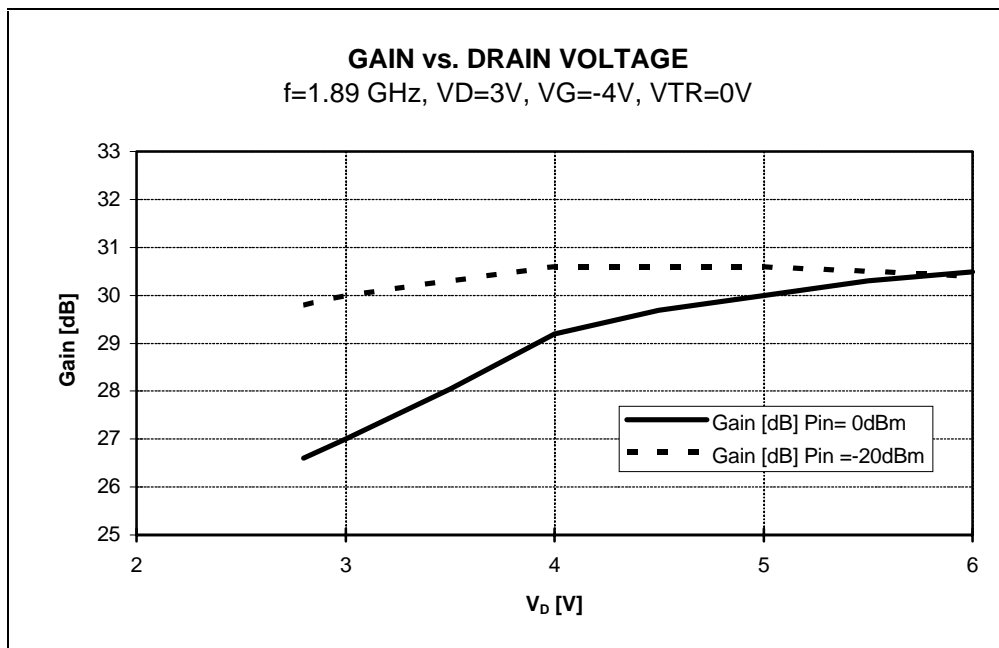
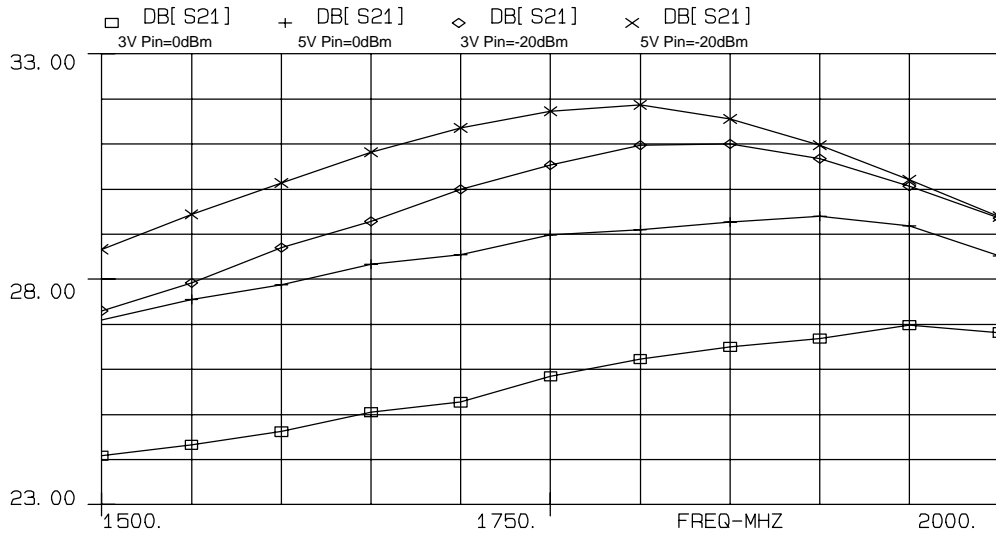

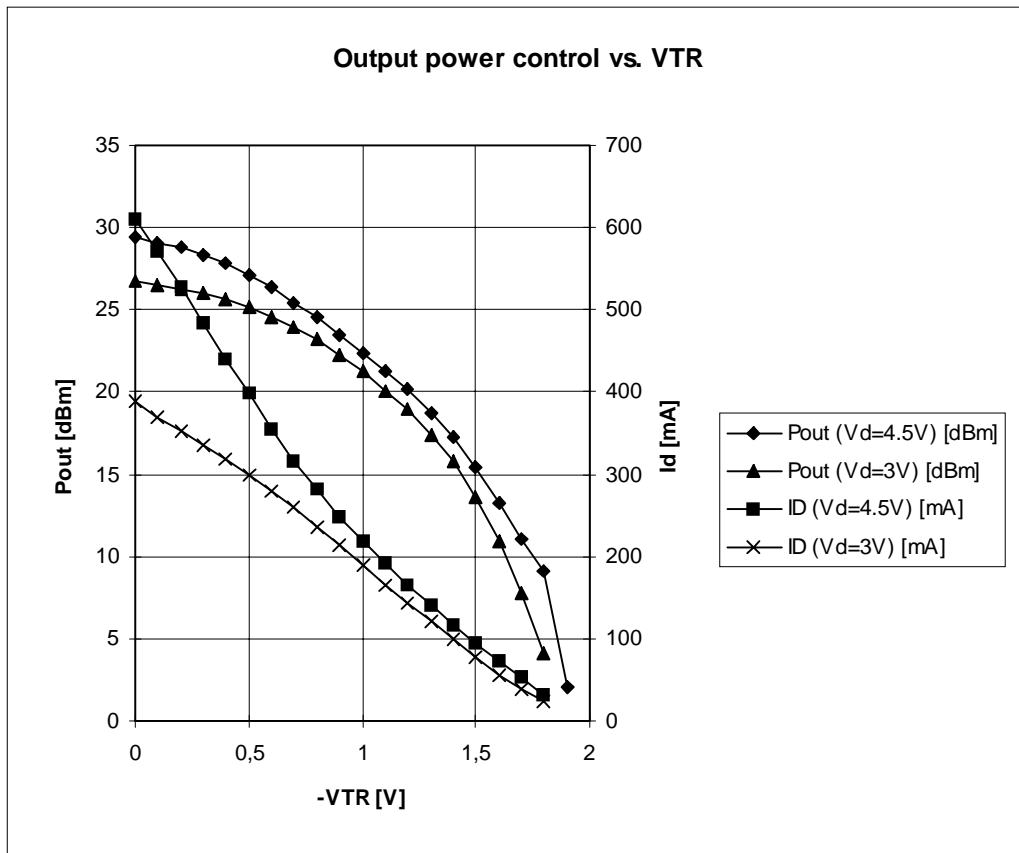

Total Power Dissipation $P_{tot}=f(T_s)$

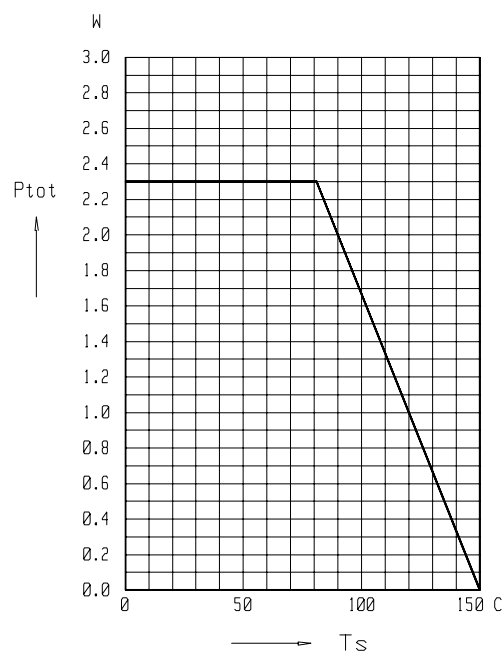

Permissible pulse load $P_{tot_max}/P_{tot_DC} = f(t_p)$

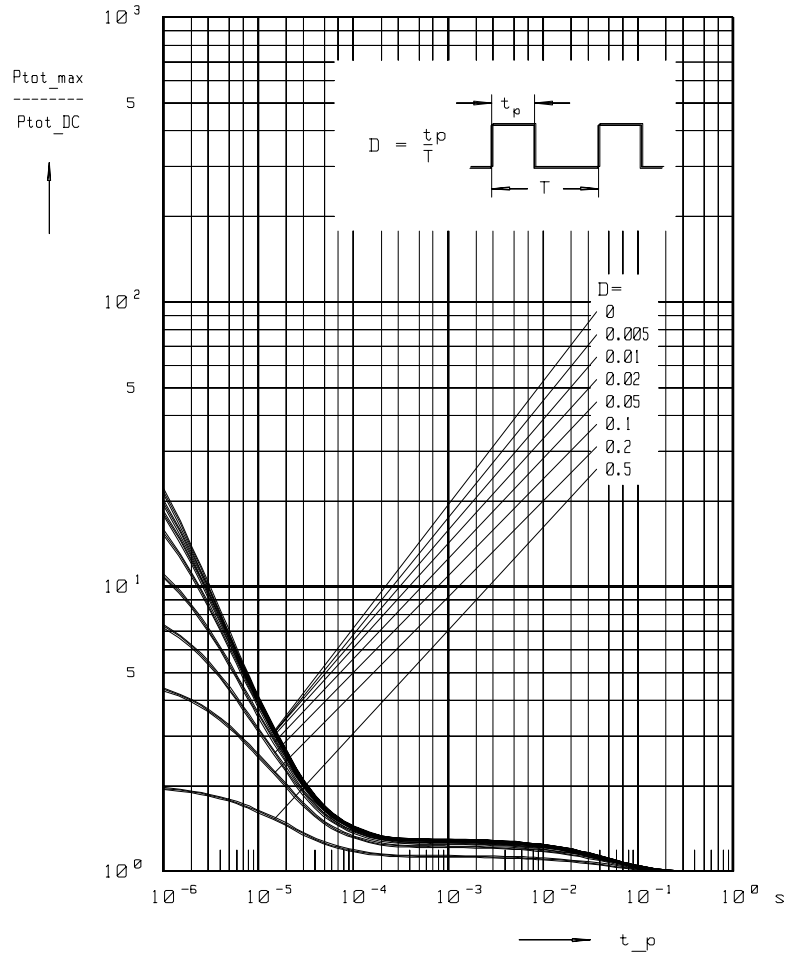

Test circuit board:

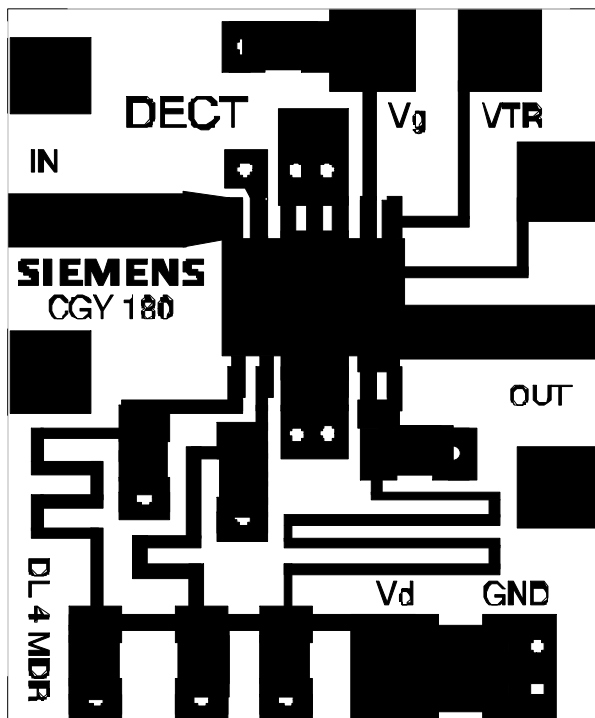

The following impedances of the bias circuit should be seen from the CGY180 ports:

$$\Gamma_8 = 0.97 / 96^\circ$$

$$\Gamma_9 = 0.96 / 142^\circ$$

$$\Gamma_{11} = 0.94 / -134^\circ$$

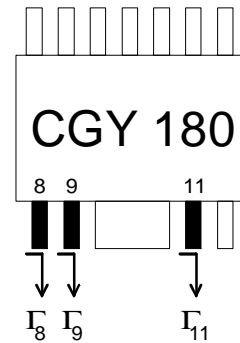

(values measured at $f=1.89$ GHz)

Size: 20 x 25 mm; In, Out: 50 Ohm

Principal circuit:

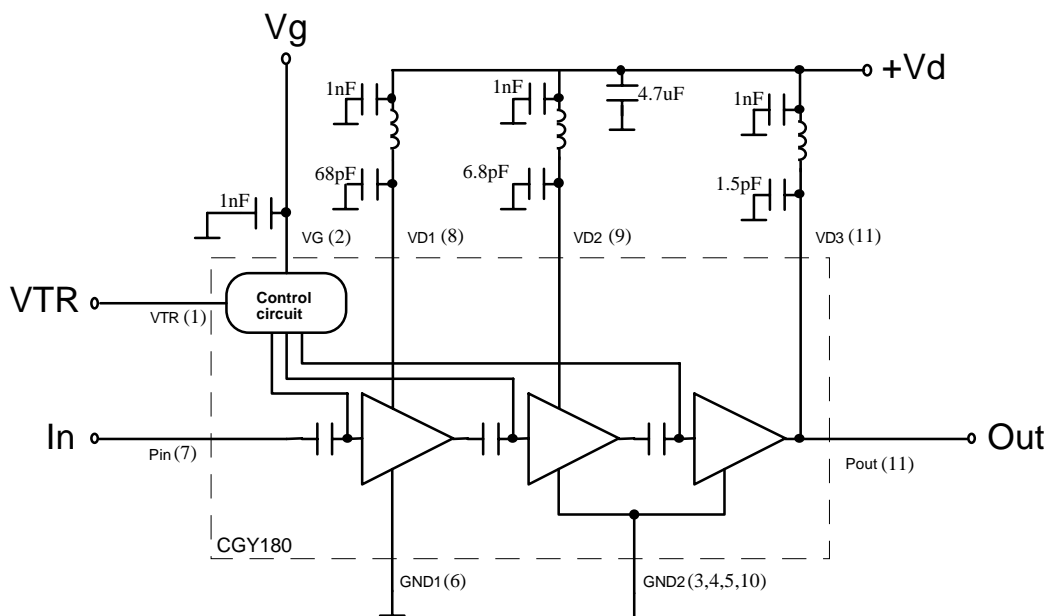

Output power at different temperatures*

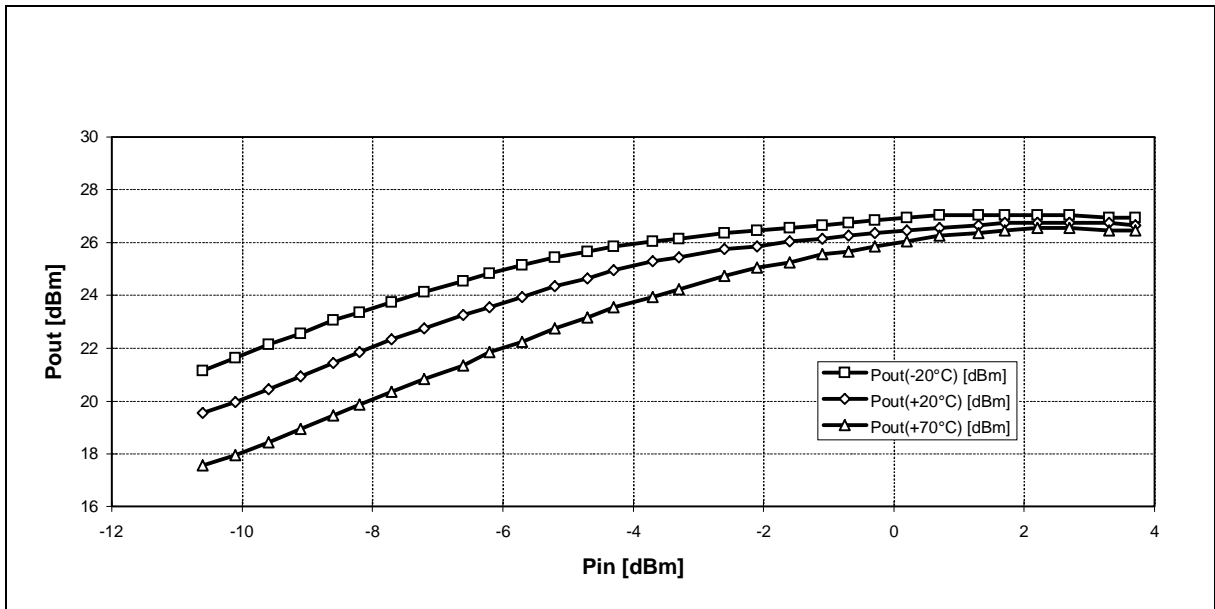

Power added efficiency at different temperatures*

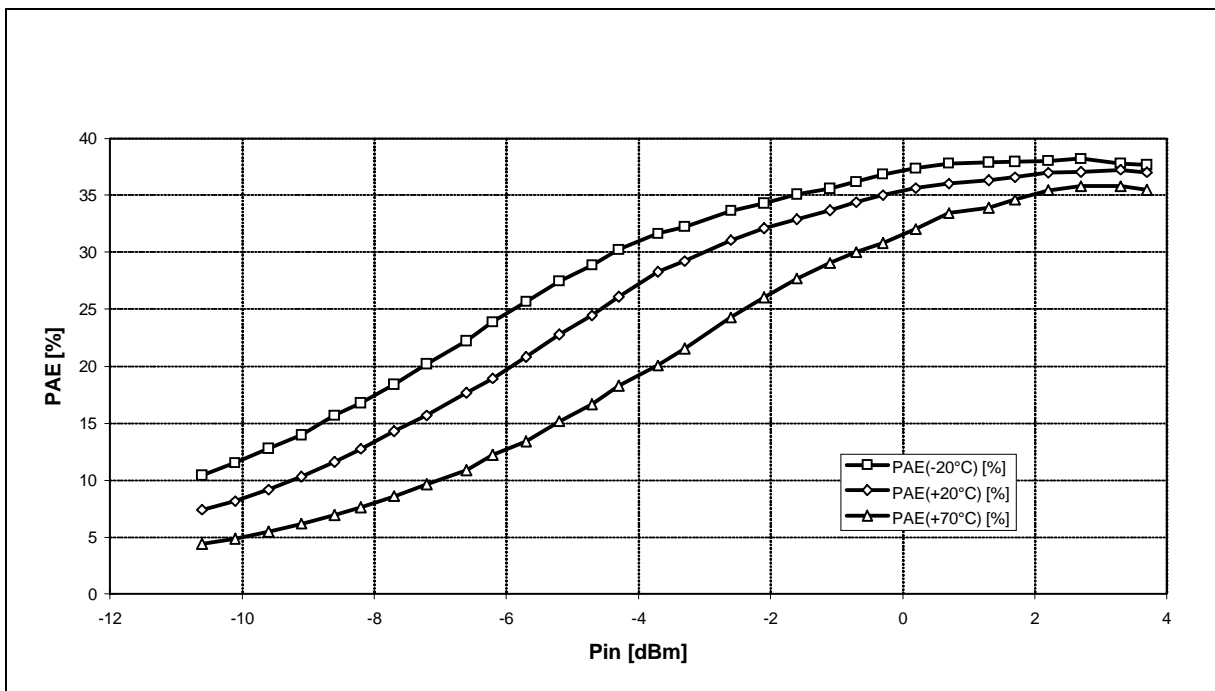

*)measured with a CGY180 test circuit board (see page 11) VD=3V, VG=-4V, VTR=0V

APPLICATION - HINTS

1. CW - capability of the CGY180

1.1 $V_D = 3\text{ V}$

Proving the possibility of CW - operations there must be known the total power dissipation of the device. This value can be found as a function of the temperature in the datasheet (page 8/14). The CGY180 has a maximum total power dissipation of $P_{\text{tot}} = 2.3\text{ W}$.

As an example we take the operating point with a drain voltage $V_D = 3\text{ V}$. The possible ratings of the drain current adjusted by the internal current control of the CGY180 ($V_G = -4\text{ V}$, $V_{\text{TR}} = 0\text{ V}$) are shown in the following table.

	Min.	Typ.	Max.
I_D / mA	325	450	650

At worst case you see a current of $I_D = 650\text{ mA}$. So the maximum DC - power can be calculated to

$$P_{DC} = V_D \cdot I_D = 1.95\text{ W}$$

This value is smaller than 2.3W and CW - operation is possible.

1.2 $V_D = 4\text{ V}$

If you want to use the whole capability of the CGY180, you must consider the power added efficiency PAE. You want to take an operation point of $V_D = 4\text{ V}$. Now there will be a higher current than at $V_D = 3\text{ V}$. We assume a current of $I_D = 650\text{ mA}$ and a $\text{PAE} = 35\%$. With these values the DC - power is $P_{DC} = 2.6\text{ W}$. That exceeds the P_{totDC} of 2.3 W. Decoupling RF-Power from the CGY180 results in less power dissipation of the device. This is directly correlated with the achieved PAE. To calculate total power dissipation use the formula:

$$P_{\text{totDC}} = P_{DC} (1 - \text{PAE})$$

P_{tot} for the used operating point shown above will be

$$P_{\text{tot}} = 2.6\text{ W}(1 - 0.35) = 1.69\text{ W}$$

It is possible to use the CGY180 for CW - operations up to a drain voltage of $V_D = 4\text{ V}$, if at the same time a PAE of 35% is achieved.

The calculation can be done for any operating point to prove the capability of CW - operation.

2. Not using the internal current control

If you don't want to use the internal current control, it is recommended to connect the negative supply voltage at pin 1 (V_{TR}) instead of pin 2 (V_G).

3. Biasing and use considerations

In all cases, RF input power should not be applied until the bias voltages have been applied, and RF input power should be turned off prior to removing the bias voltages. Bias application should be timed such that gate voltage (V_{GG}) is always applied before the drain voltages (V_{DD}), and when returning to the standby mode, gate voltage should only be removed once the drain voltages have been removed.