

**QTLP673C-O** Yellow-Orange  
**QTLP673C-R** Red  
**QTLP673C-IG** True Green

**QTLP673C-Y** Yellow  
**QTLP673C-IB** Blue

**QTLP673C-E** Orange  
**QTLP673C-IC** Cyan

**PACKAGE DIMENSIONS**

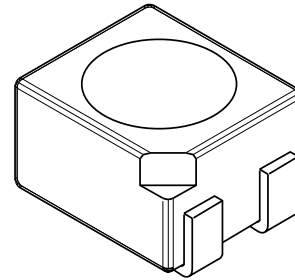
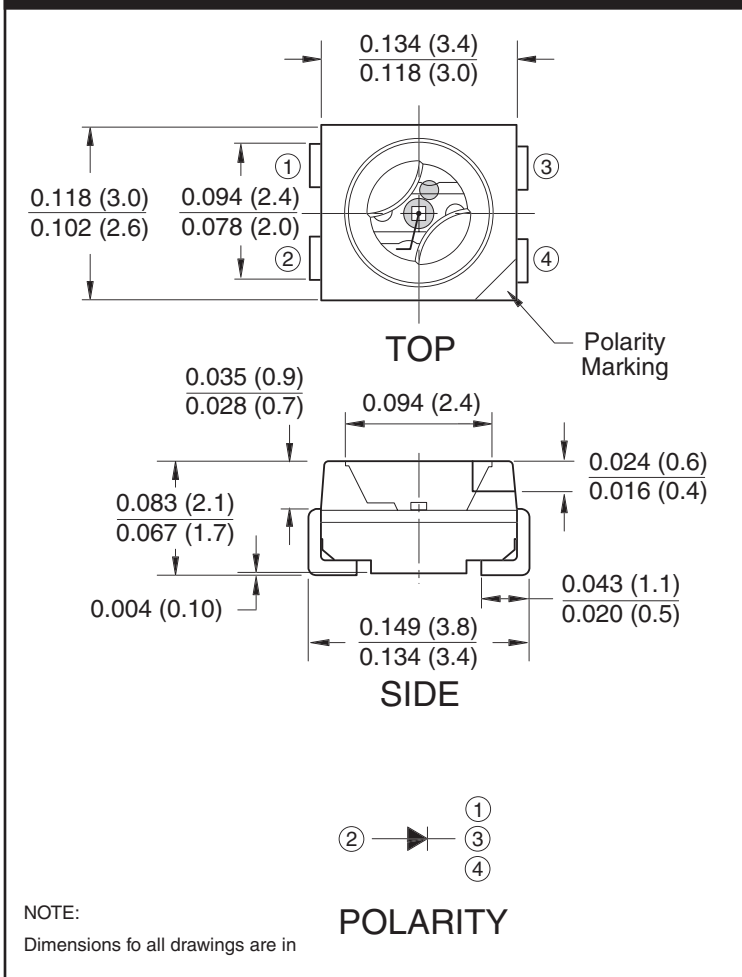

**APPLICATIONS**

- Automotive interior lighting
- Status indication for consumer electronics and office equipment
- Information display lighting

**DESCRIPTION**

This ultra bright high current surface mount LED is designed with flat top and sides for the ease of pick-and-place by automatic placement equipment. It is compatible with both IR reflow and TTW (Through-the-Wave) soldering. These LEDs are ideal for back-lighting and optical coupling into light pipes.

**FEATURES**

- Small package dimensions of 3.2(L) x 2.8(W) x 1.8(H) mm
- AlInGaP technology for -Y, -O, -R, and -E
- InGaN technology for -IB, -IC, and -IG
- Wide viewing angle of 120°
- Water clear optics
- Available in 0.315" (8mm) width tape on 7" (178mm) diameter reel; 2,000 units per reel

**QTLP673C-O** Yellow-Orange      **QTLP673C-Y** Yellow      **QTLP673C-E** Orange  
**QTLP673C-R** Red                      **QTLP673C-IB** Blue      **QTLP673C-IC** Cyan  
**QTLP673C-IG** True Green

**ABSOLUTE MAXIMUM RATINGS** ( $T_A = 25^\circ\text{C}$  Unless otherwise specified)

Parameter	Symbol	QTLP673C-Y/-E/-O/-R	Units
Continuous Forward Current	$I_F$	70	mA
Peak Forward Current ( $f = 100$ KHz, Duty Factor = 1/10)	$I_{FM}$	100	mA
Reverse Voltage	$V_R$	5	V
Power Dissipation	$P_D$	180	mW
Junction Temperature	$T_J$	125	$^\circ\text{C}$
Operating Temperature	$T_{OPR}$	-40 to +100	$^\circ\text{C}$
Storage Temperature	$T_{STG}$	-40 to +100	$^\circ\text{C}$
Lead Soldering Time	$T_{SOL}$	260 for 5 sec	$^\circ\text{C}$

**ELECTRICAL / OPTICAL CHARACTERISTICS** ( $T_A = 25^\circ\text{C}$ )

Part Number	Symbol	QTLP673C				Condition
		-Y	-E	-O	-R	
Luminous Intensity (mcd)	$I_V$	T1: 285-355	T1: 285-355	T1: 285-355	T1: 285-355	$I_F = 50\text{mA}$
		T2: 355-450	T2: 355-450	T2: 355-450	T2: 355-450	
		U1: 450-560	U1: 450-560	U1: 450-560	U1: 450-560	
		U2: 560-715	U2: 560-715	U2: 560-715	U2: 560-715	
Forward Voltage (V) 51	$V_F$	2.0-2.3	2.0-2.3	2.0-2.3	2.0-2.3	$I_F = 50\text{mA}$
		52	2.3-2.6	2.3-2.6	2.3-2.6	
Dominant Wavelength (nm)	$\lambda_D$	W: 582-585	W: 610-615	W: 600-603	—	$I_F = 50\text{mA}$
		X: 585-588	X: 615-621	X: 603-606	—	
		Y: 588-591	—	Y: 606-609	—	
		Z: 591-594	—	Z: 609-612	—	
		—	—	—	Full: 620-630	
Viewing Angle ( $^\circ$ )	$2\theta^{1/2}$	120	120	120	120	$I_F = 50\text{mA}$

**QTLP673C-O** Yellow-Orange  
**QTLP673C-R** Red  
**QTLP673C-IG** True Green

**QTLP673C-Y** Yellow  
**QTLP673C-IB** Blue

**QTLP673C-E** Orange  
**QTLP673C-IC** Cyan

**ABSOLUTE MAXIMUM RATINGS** ( $T_A = 25^\circ\text{C}$  Unless otherwise specified)

Parameter	Symbol	QTLP673C-IG/IC/IB	Units
Continuous Forward Current	$I_F$	30	mA
Peak Forward Current ( $f = 100$ KHz, Duty Factor = 1/10)	$I_{FM}$	200	mA
Reverse Voltage	$V_R$	5	V
Power Dissipation	$P_D$	135	mW
Junction Temperature	$T_J$	125	$^\circ\text{C}$
Operating Temperature	$T_{OPR}$	-40 to +100	$^\circ\text{C}$
Storage Temperature	$T_{STG}$	-40 to +100	$^\circ\text{C}$
Lead Soldering Time	$T_{SOL}$	260 for 5 sec	$^\circ\text{C}$

**ELECTRICAL / OPTICAL CHARACTERISTICS** ( $T_A = 25^\circ\text{C}$ )

Part Number	Symbol	QTLP673C			Condition
		-IG	-IB	-IC	
Luminous Intensity (mcd)	$I_V$	T1: 285-355	Q2: 90-112.5	T1: 285-355	$I_F = 30\text{mA}$
		T2: 355-450	R1: 112.5-140	T2: 355-450	
		U1: 450-560	R2: 140-180	U1: 450-560	
		U2: 560-715	S1: 180-224	U2: 560-715	
		V1: 715-900	S2: 280-355	V1: 715-900	
		V2: 900-1125		V2: 900-1125	
Forward Voltage (V)	$V_F$	Typ	3.9	3.9	$I_F = 30\text{mA}$
		Max	4.55	4.55	
Dominant Wavelength (nm)	$\lambda_D$	W: 520-524	W: 464-468	W: 499-503	$I_F = 30\text{mA}$
		X: 524-528	X: 468-472	X: 503-507	
		Y: 528-532	Y: 472-476	Y: 507-511	
		Z: 532-536	Z: 476-480	—	
		—	—	—	
Viewing Angle ( $^\circ$ )	$2\theta^{1/2}$	120	120	120	$I_F = 30\text{mA}$

Tolerance for Luminous Intensity ( $I_V$ ):  $\pm 11\%$

Tolerance for  $V_F$ :  $\pm 0.1\text{V}$

Tolerance for  $\lambda_D$ :  $\pm 1\text{nm}$

**QTLP673C-O** Yellow-Orange  
**QTLP673C-R** Red  
**QTLP673C-IG** True Green

**QTLP673C-Y** Yellow  
**QTLP673C-IB** Blue

**QTLP673C-E** Orange  
**QTLP673C-IC** Cyan

**TYPICAL PERFORMANCE CURVES QTLP673C-O/-R/-Y/-E**

**Fig. 1 Forward Current (mA) vs. Forward Voltage**

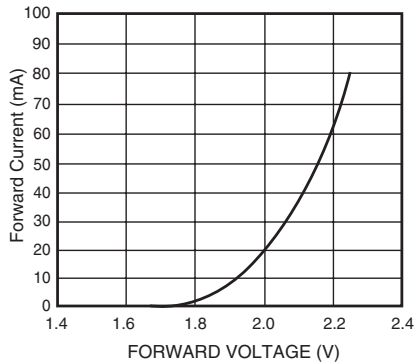

**Fig. 2 Relative Luminous Intensity vs. Forward Current**

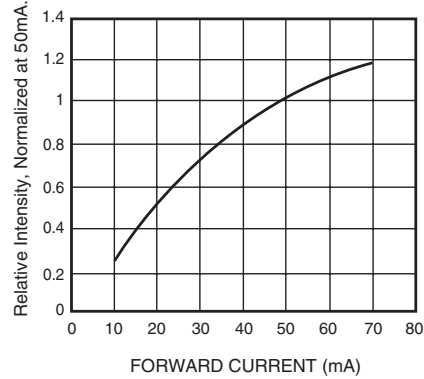

**Fig. 3 Relative Intensity vs. Peak Wavelength**

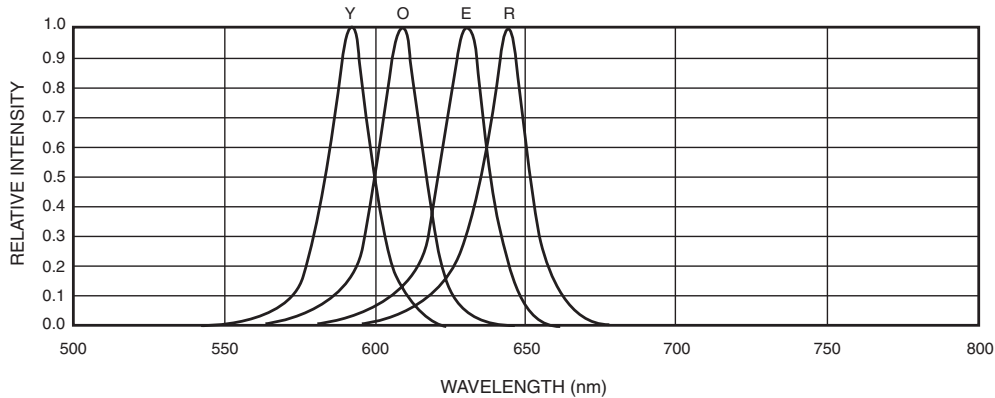

**Fig. 4 Radiation Diagram**

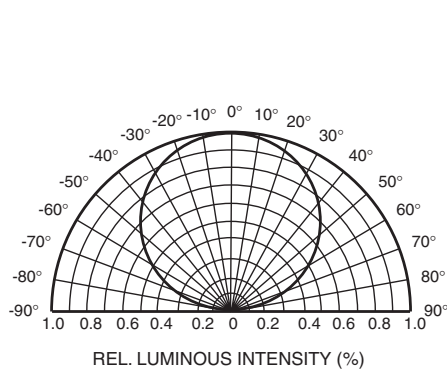

**Fig. 5 Maximum Forward Current vs. Ambient Temperature**

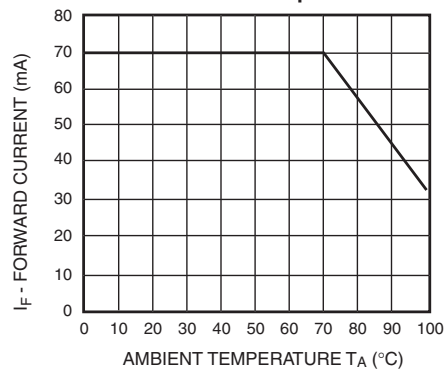

**QTLP673C-O** Yellow-Orange  
**QTLP673C-R** Red  
**QTLP673C-IG** True Green

**QTLP673C-Y** Yellow  
**QTLP673C-IB** Blue

**QTLP673C-E** Orange  
**QTLP673C-IC** Cyan

**TYPICAL PERFORMANCE CURVES QTLP673C-IC/-IB/-IG**

**Fig. 1 Forward Current (mA) vs. Forward Voltage**

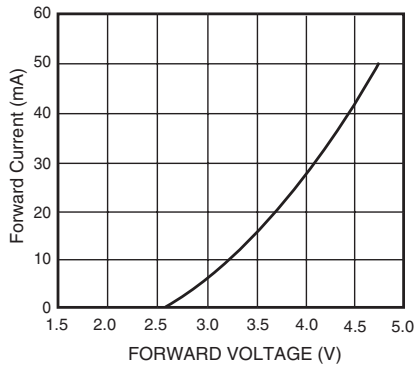

**Fig. 2 Relative Luminous Intensity vs. Forward Current**

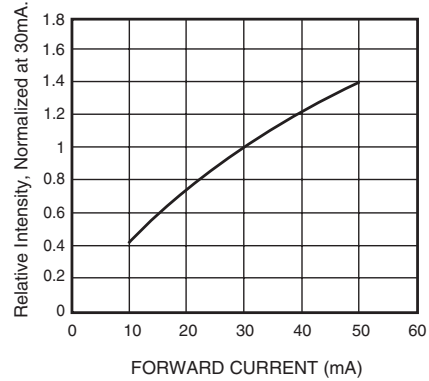

**Fig. 3 Relative Intensity vs. Peak Wavelength**

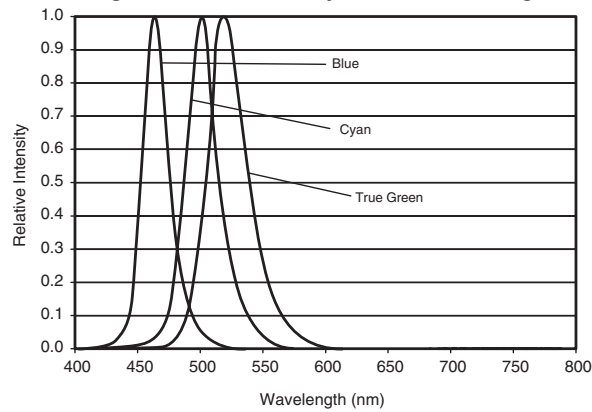

**Fig. 4 Radiation Diagram**

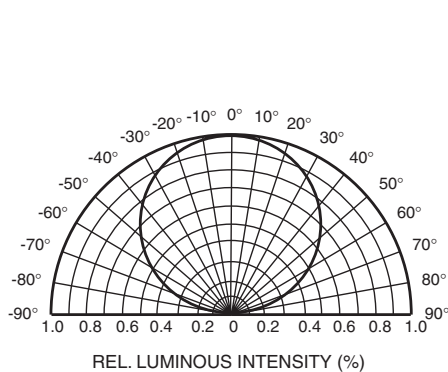

**Fig. 5 Maximum Forward Current vs. Ambient Temperature**

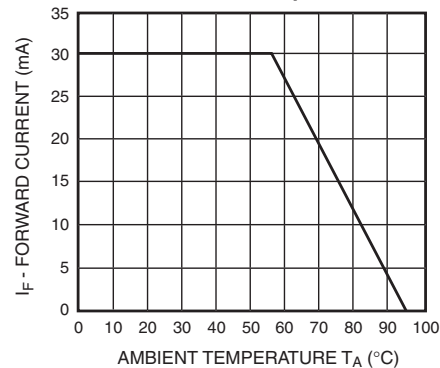

QTLP673C-O Yellow-Orange  
QTLP673C-R Red  
QTLP673C-IG True Green

QTLP673C-Y Yellow  
QTLP673C-IB Blue

QTLP673C-E Orange  
QTLP673C-IC Cyan

**RECOMMENDED PRINTED CIRCUIT BOARD PATTERN**

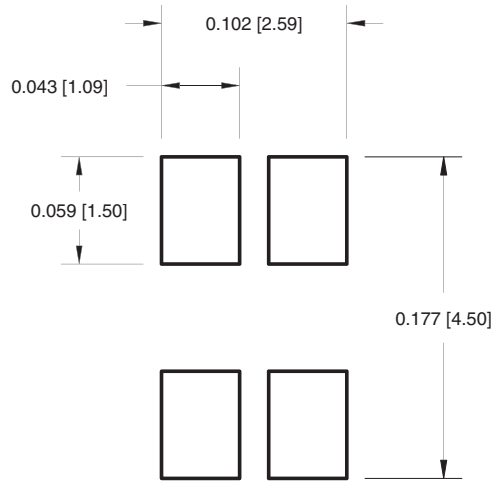

**RECOMMENDED IR REFLOW SOLDERING PROFILE**

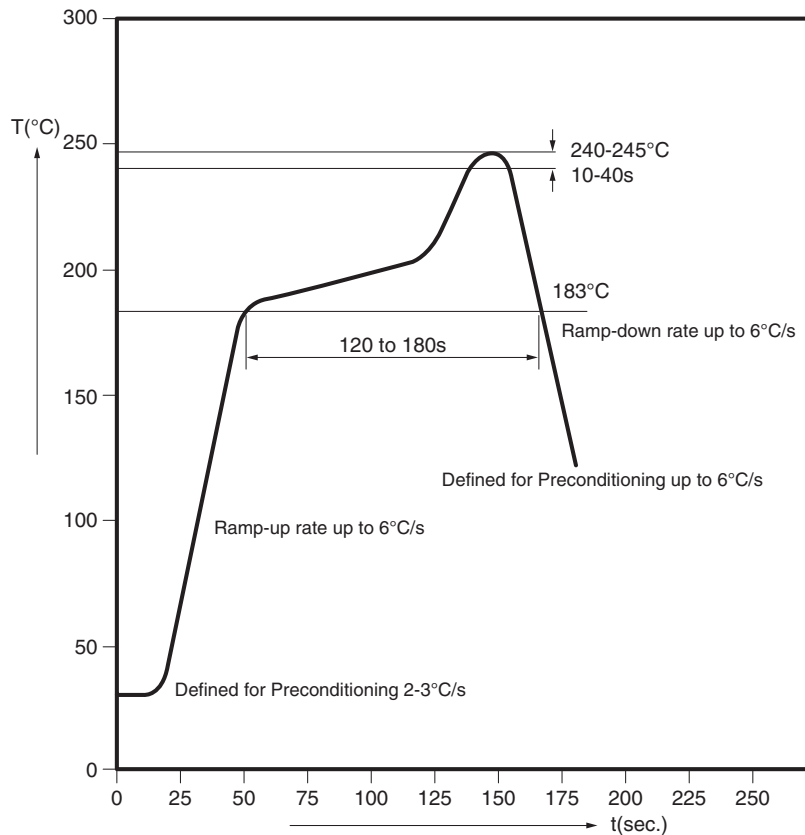

**QTLP673C-O** Yellow-Orange  
**QTLP673C-R** Red  
**QTLP673C-IG** True Green

**QTLP673C-Y** Yellow  
**QTLP673C-IB** Blue

**QTLP673C-E** Orange  
**QTLP673C-IC** Cyan

**RECOMMENDED TTW REFLOW SOLDERING PROFILE**

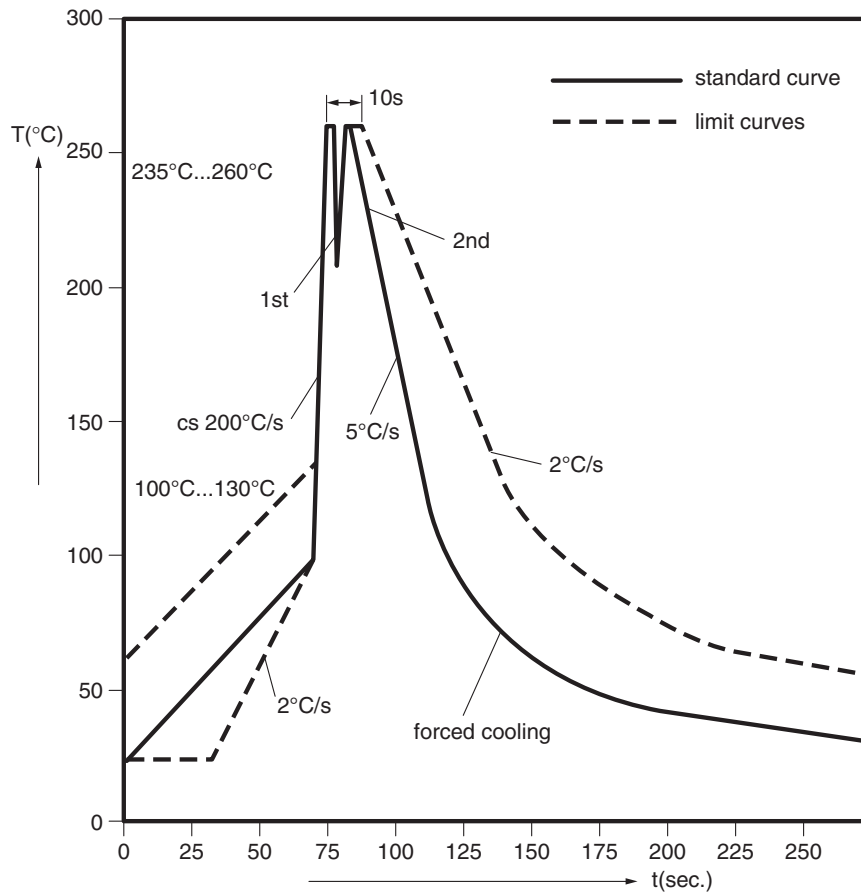

**ORDERING INFORMATION**

Orderable Part Number	Color	Package
QTLP673C-OTR	Yellow-Orange	Power PLCC-4
QTLP673C-RTR	Red	Power PLCC-4
QTLP673C-IGTR	True Green	Power PLCC-4
QTLP673C-YTR	Yellow	Power PLCC-4
QTLP673C-IBTR	Blue	Power PLCC-4
QTLP673C-ETR	Orange	Power PLCC-4
QTLP673C-ICTR	Cyan	Power PLCC-4

QTLP673C-O Yellow-Orange  
QTLP673C-R Red  
QTLP673C-IG True Green

QTLP673C-Y Yellow  
QTLP673C-IB Blue

QTLP673C-E Orange  
QTLP673C-IC Cyan

**TAPE AND REEL DIMENSIONS**

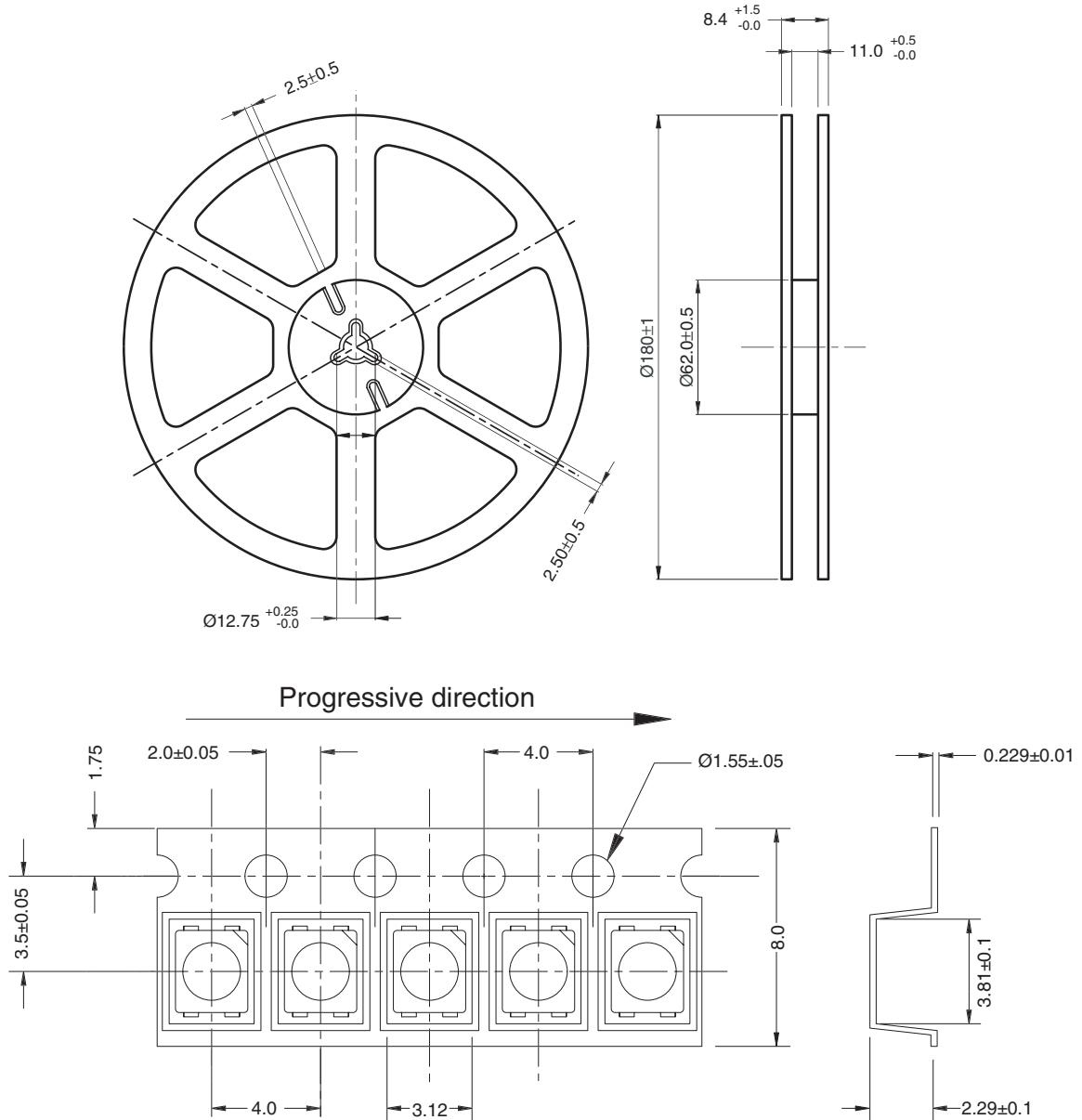

Dimensional tolerance is  $\pm 0.1$ mm unless otherwise specified

Angle:  $\pm 0.5$

Unit: mm



---

<b>QTLP673C-O</b> Yellow-Orange	<b>QTLP673C-Y</b> Yellow	<b>QTLP673C-E</b> Orange
<b>QTLP673C-R</b> Red	<b>QTLP673C-IB</b> Blue	<b>QTLP673C-IC</b> Cyan
<b>QTLP673C-IG</b> True Green		

---

**DISCLAIMER**

FAIRCHILD SEMICONDUCTOR RESERVES THE RIGHT TO MAKE CHANGES WITHOUT FURTHER NOTICE TO ANY PRODUCTS HEREIN TO IMPROVE RELIABILITY, FUNCTION OR DESIGN. FAIRCHILD DOES NOT ASSUME ANY LIABILITY ARISING OUT OF THE APPLICATION OR USE OF ANY PRODUCT OR CIRCUIT DESCRIBED HEREIN; NEITHER DOES IT CONVEY ANY LICENSE UNDER ITS PATENT RIGHTS, NOR THE RIGHTS OF OTHERS.

**LIFE SUPPORT POLICY**

FAIRCHILD'S PRODUCTS ARE NOT AUTHORIZED FOR USE AS CRITICAL COMPONENTS IN LIFE SUPPORT DEVICES OR SYSTEMS WITHOUT THE EXPRESS WRITTEN APPROVAL OF THE PRESIDENT OF FAIRCHILD SEMICONDUCTOR CORPORATION. As used herein:

1. Life support devices or systems are devices or systems which, (a) are intended for surgical implant into the body, or (b) support or sustain life, and (c) whose failure to perform when properly used in accordance with instructions for use provided in the labeling, can be reasonably expected to result in a significant injury of the user.
2. A critical component in any component of a life support device or system whose failure to perform can be reasonably expected to cause the failure of the life support device or system, or to affect its safety or effectiveness.