

---

# SC82 120mA LDO REGULATOR

## R1140Q SERIES

### APPLICATION MANUAL

## OUTLINE

The R1140Q Series are voltage regulator ICs with high output voltage accuracy, low supply current, low ON-resistance, and high ripple rejection by CMOS process. Each of these voltage regulator ICs consists of a voltage reference unit, an error amplifier, resistors for setting Output Voltage, a current limit circuit, and a chip enable circuit.

These ICs perform with low dropout voltage and a chip enable function. The line transient response and load transient response of the R1140Q Series are excellent, thus these ICs are very suitable for the power supply for hand-held communication equipment.

The output voltage of these ICs is internally fixed with high accuracy. Since the package for these ICs is SC-82AB (Super Mini-mold) package, high density mounting of the ICs on boards is possible.

## FEATURES

- Ultra-Low Supply Current ..... TYP. 75 $\mu$ A
- Standby Mode ..... TYP. 0.1 $\mu$ A
- Low Dropout Voltage ..... TYP. 0.15V ( $I_{OUT}$ = 100mA Output Voltage= 3.0V Type)
- High Ripple Rejection ..... TYP. 75dB (f= 1kHz)
- Low Temperature-Drift Coefficient of Output Voltage..... TYP.  $\pm$  100ppm/ $^{\circ}$ C
- Excellent Line Regulation..... TYP. 0.05%/V
- High Output Voltage Accuracy .....  $\pm$  2.0%
- Excellent Dynamic Response
- Small Package ..... SC-82AB (Super Mini-mold)
- Output Voltage ..... Stepwise setting with a step of 0.1V in the range of 1.5V to 4.0V is possible
- Built-in chip enable circuit (B/D: active high)
- Built-in fold-back protection circuit..... TYP. 40mA (Current at short mode)

## APPLICATIONS

- Power source for cellular phones such as GSM, CDMA and various kinds of PCS.
- Power source for electrical appliances such as cameras, VCRs and camcorders.
- Power source for battery-powered equipment.

## BLOCK DIAGRAM

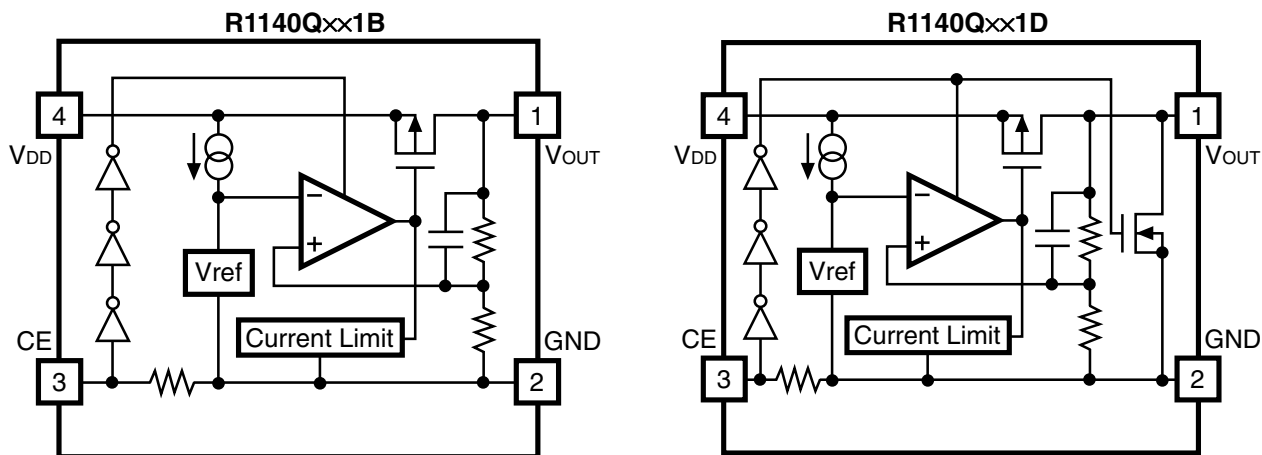

## SELECTION GUIDE

The output voltage, mask option, and the taping type for the ICs can be selected at the user's request. The selection can be made by designating the part number as shown below;

R1140Qxx1x-xx ← Part Number  
 ↑ ↑ ↑ ↑  
 a b c d

Code	Contents
a	Designation of Package Type : Q: SC82-AB (Super Mini-mold)
b	Setting Output Voltage ( $V_{OUT}$ ) : Stepwise setting with a step of 0.1V in the range of 1.5V to 4.0V is possible.
c	Designation of Mask Option : B: Without auto discharge function at OFF state. D: With auto discharge function at OFF state.
d	Designation of Taping Type : Ex. TR, TL (refer to Taping Specifications; TR type is the standard direction.)

## PIN CONFIGURATION

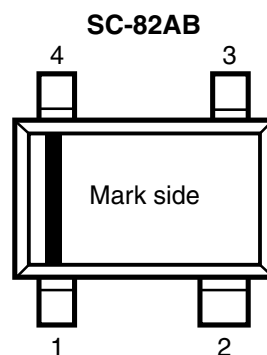

## PIN DESCRIPTION

Pin No.	Symbol	Description
1	$V_{OUT}$	Output pin
2	GND	Ground Pin
3	CE	Chip Enable Pin
4	$V_{DD}$	Input Pin

## ABSOLUTE MAXIMUM RATINGS

Symbol	Item	Rating	Unit
$V_{IN}$	Input Voltage	6.5	V
$V_{CE}$	Input Voltage (CE Pin)	-0.3 ~ $V_{IN} + 0.3$	V
$V_{OUT}$	Output Voltage	-0.3 ~ $V_{IN} + 0.3$	V
$I_{OUT}$	Output Current	140	mA
$P_D$	Power Dissipation	150	mW
$T_{opt}$	Operating Temperature Range	-40 ~ 85	°C
$T_{stg}$	Storage Temperature Range	-55 ~ 125	°C

## ELECTRICAL CHARACTERISTICS

• R1140Qxx1B/R1140Qxx1D

T<sub>opt</sub> = 25°C

Symbol	Item	Conditions	MIN.	TYP.	MAX.	Unit
V <sub>OUT</sub>	Output Voltage	V <sub>IN</sub> = Set V <sub>OUT</sub> + 1V 1mA ≤ I <sub>OUT</sub> ≤ 30mA	V <sub>OUT</sub> ×0.98		V <sub>OUT</sub> ×1.02	V
I <sub>OUT</sub>	Output Current	V <sub>IN</sub> -V <sub>OUT</sub> = 1.0V	120			mA
ΔV <sub>OUT</sub> /ΔI <sub>OUT</sub>	Load Regulation	V <sub>IN</sub> = Set V <sub>OUT</sub> + 1V 1mA ≤ I <sub>OUT</sub> ≤ 120mA		12	40	mV
V <sub>DIF</sub>	Dropout Voltage	Refer to the ELECTRICAL CHARACTERISTICS by OUTPUT VOLT-AGE				
I <sub>SS</sub>	Supply Current	V <sub>IN</sub> = Set V <sub>OUT</sub> + 1V		75	150	μA
I <sub>standby</sub>	Supply Current (Standby)	V <sub>IN</sub> = V <sub>CE</sub> = Set V <sub>OUT</sub> + 1V		0.1	1.0	μA
ΔV <sub>OUT</sub> /ΔV <sub>IN</sub>	Line Regulation	Set V <sub>OUT</sub> + 0.5V ≤ V <sub>IN</sub> ≤ 6V I <sub>OUT</sub> = 30mA (In case that V <sub>OUT</sub> ≤ 1.6V, 2.2V ≤ V <sub>IN</sub> ≤ 6V)		0.05	0.20	%/V
RR	Ripple Rejection	f = 1kHz, Ripple 0.5Vp-p V <sub>IN</sub> = Set V <sub>OUT</sub> + 1V, I <sub>OUT</sub> = 30mA (In case that V <sub>OUT</sub> ≤ 1.7V, V <sub>IN</sub> - V <sub>OUT</sub> = 1.2V)		75		dB
V <sub>IN</sub>	Input Voltage		2.2		6.0	V
ΔV <sub>OUT</sub> /ΔT	Output Voltage Temperature Coefficient	I <sub>OUT</sub> = 30mA -40°C ≤ T <sub>opt</sub> ≤ 85°C		± 100		ppm /°C
I <sub>LM</sub>	Short Current Limit	V <sub>OUT</sub> = 0V		40		mA
R <sub>PU</sub>	$\overline{\text{CE}}$ Pull-up Resistance		1.5	4	16	MΩ
V <sub>CEH</sub>	$\overline{\text{CE}}$ Input Voltage "H"		1.5		V <sub>IN</sub>	V
V <sub>CEL</sub>	$\overline{\text{CE}}$ Input Voltage "L"		0.0		0.3	V
en	Output Noise	BW = 10Hz to 100kHz		30		μVrms
R <sub>LOW</sub>	Low Output Nch Tr. ON Resistance (of D version)	V <sub>CE</sub> = 0V		70		Ω

• **ELECTRICAL CHARACTERISTICS by OUTPUT VOLTAGE**

$T_{opt} = 25^{\circ}\text{C}$

Output Voltage $V_{OUT}$ (V)	Dropout Voltage		
	$V_{DIF}$ (V)		
	Condition	TYP.	MAX.
$1.5 \leq V_{OUT} \leq 1.6$	$I_{OUT} = 120\text{mA}$	0.36	0.70
$1.7 \leq V_{OUT} \leq 1.8$		0.30	0.50
$1.9 \leq V_{OUT} \leq 2.0$		0.28	0.45
$2.1 \leq V_{OUT} \leq 2.7$		0.24	0.40
$2.8 \leq V_{OUT} \leq 4.0$		0.18	0.30

## TECHNICAL NOTES

When using these ICs, consider the following points:

### Phase Compensation

In these ICs, phase compensation is made for securing stable operation even if the load current is varied. For this purpose, be sure to use a  $2.2\mu\text{F}$  or more capacitor  $C_{OUT}$  with good frequency characteristics and ESR (Equivalent Series Resistance).

(Note: When the additional ceramic capacitors are connected to the Output Pin with Output capacitor for phase compensation, the operation might be unstable. Because of this, test these ICs with as same external components as ones to be used on the PCB.)

### PCB Layout

Make  $V_{DD}$  and GND line sufficient. When the impedance of these is high, it would be a cause of picking up the noise or unstable operation. Connect a capacitor with as much as  $1.0\mu\text{F}$  capacitor between  $V_{DD}$  and GND pin as close as possible.

Set external components, especially output capacitor as close as possible to the ICs and make wiring shortest.

### TEST CIRCUITS

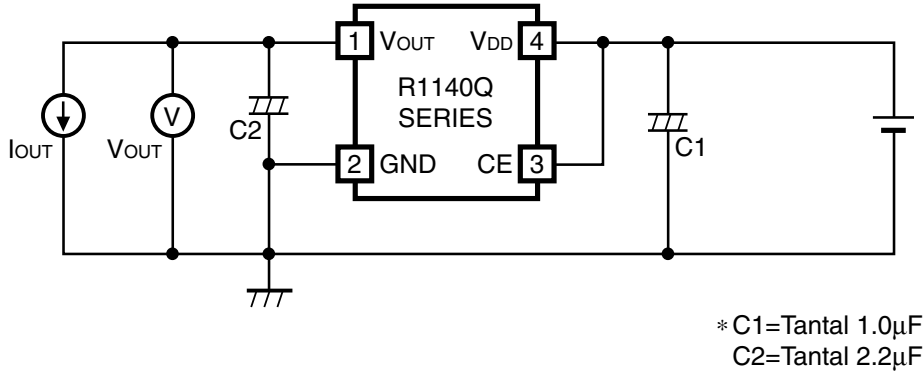

Fig.1 Standard test Circuit

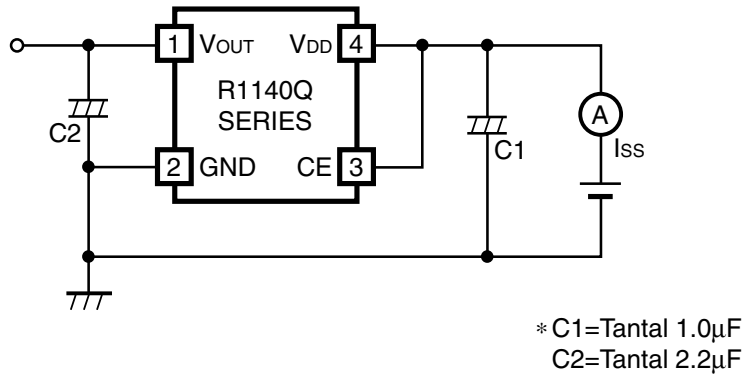

Fig.2 Supply Current Test Circuit

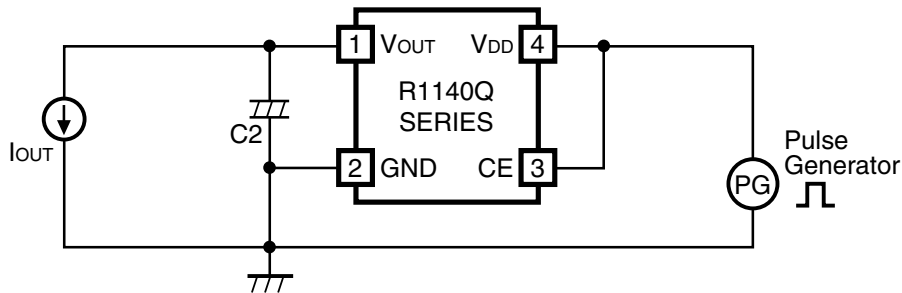

Fig.3 Ripple Rejection, Line Transient Response Test Circuit

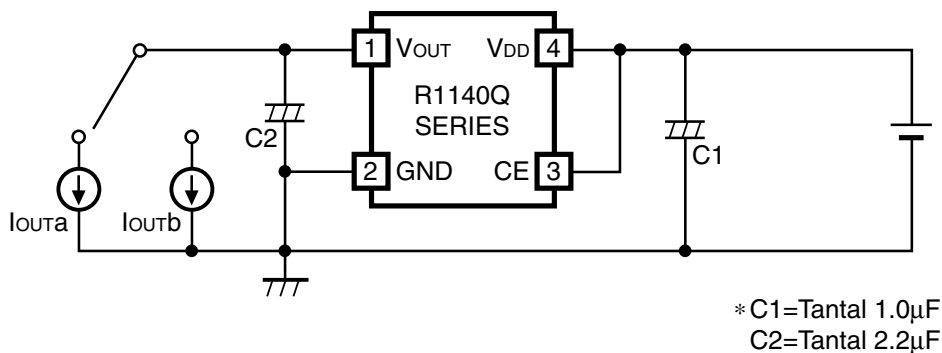
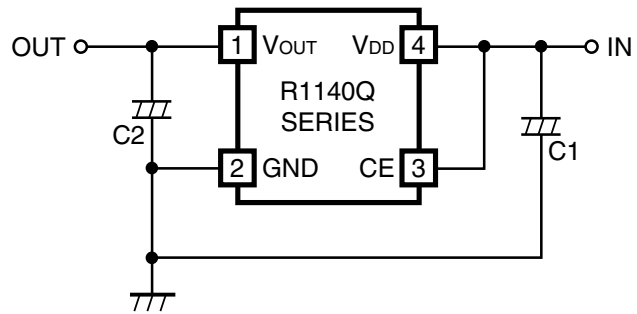

Fig.4 Load Transient Response Test Circuit

## TYPICAL APPLICATION



(External Components)

Output Capacitor; Tantalum Type



## TYPICAL CHARACTERISTICS

### 1) Output Voltage vs. Output Current

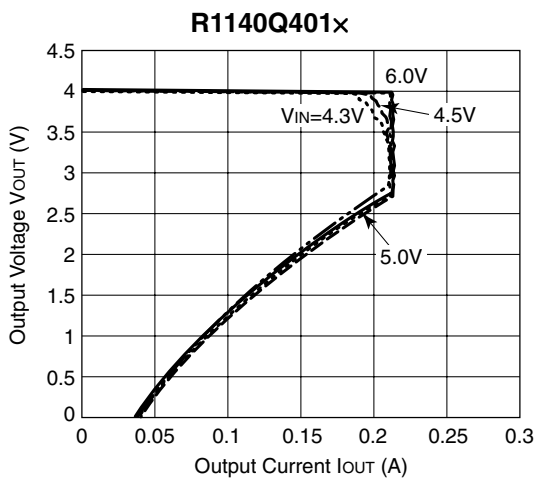
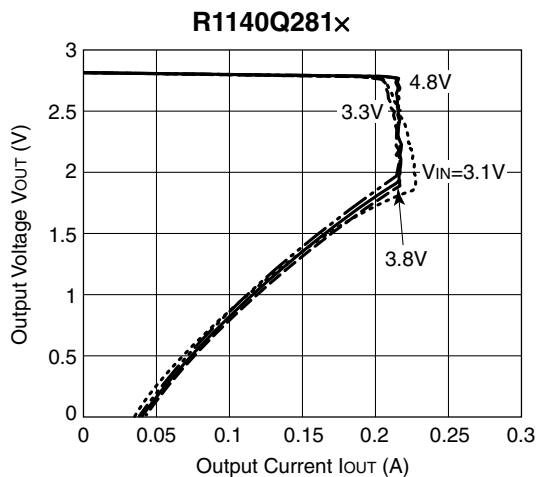
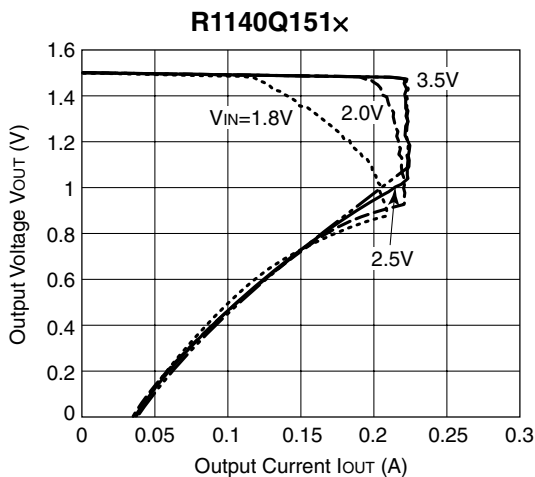

### 2) Output Voltage vs. Input Voltage

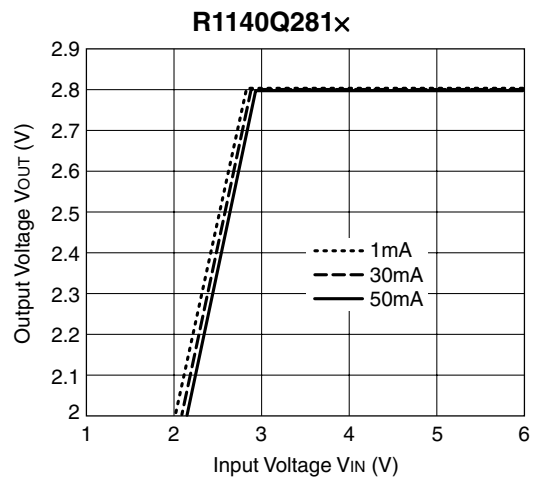
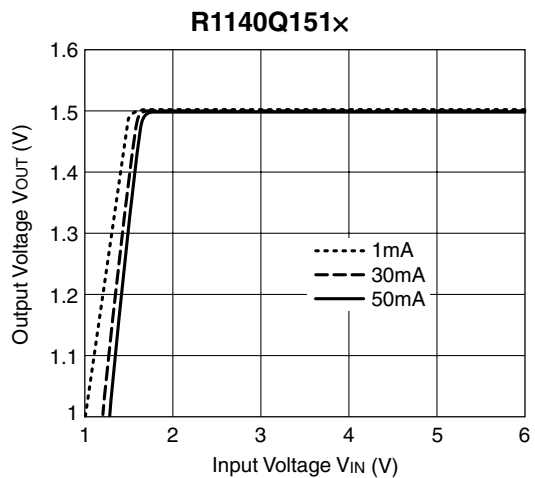

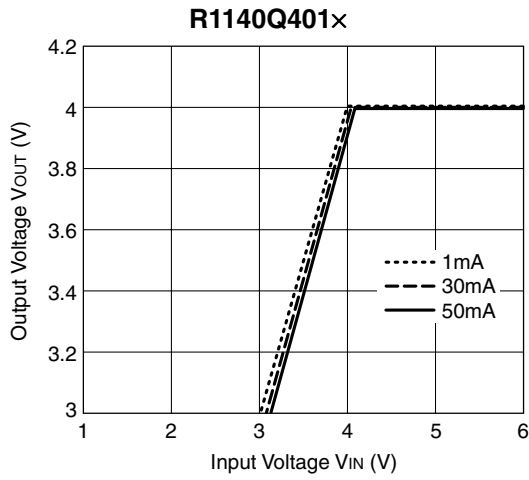

3) Dropout Voltage vs. Output Current

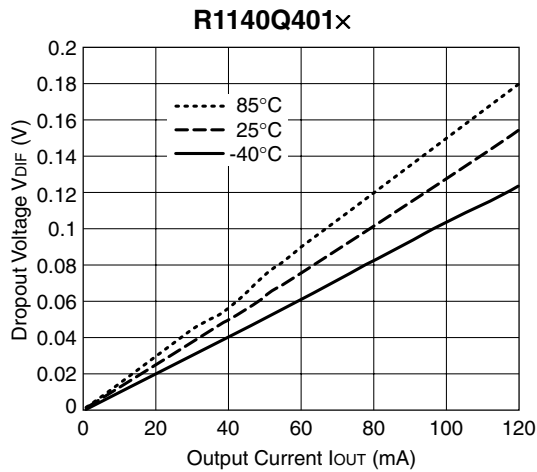
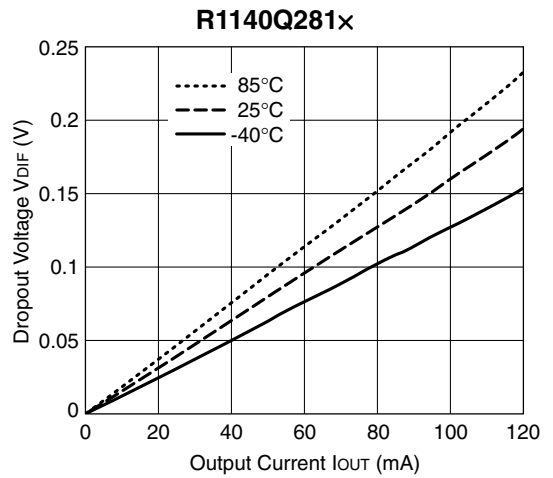
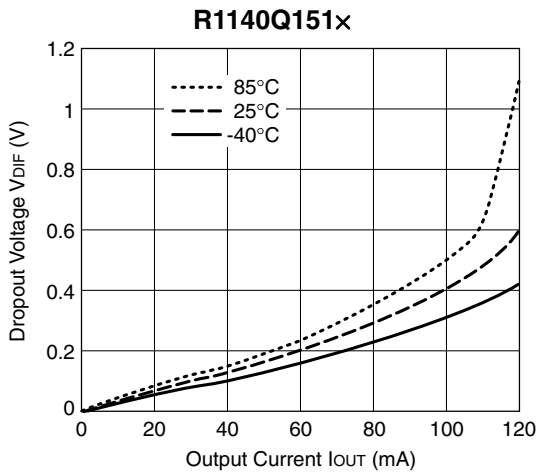

4) Output Voltage vs. Temperature

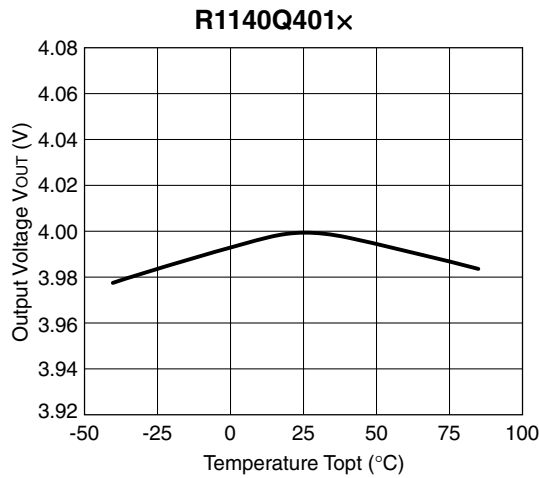
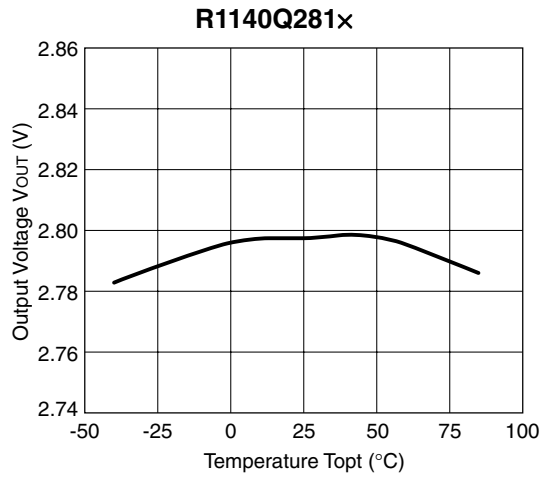
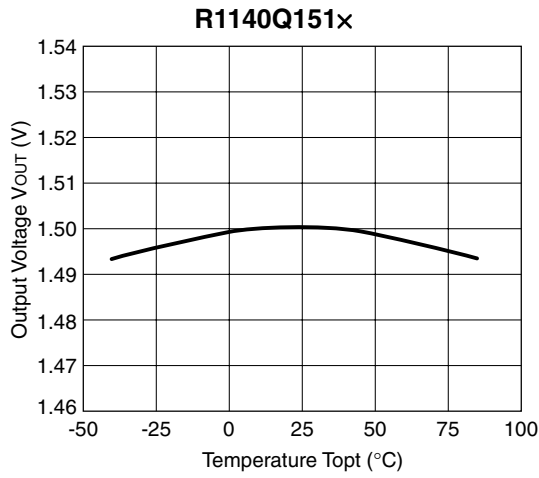

5) Supply Current vs. Input Voltage

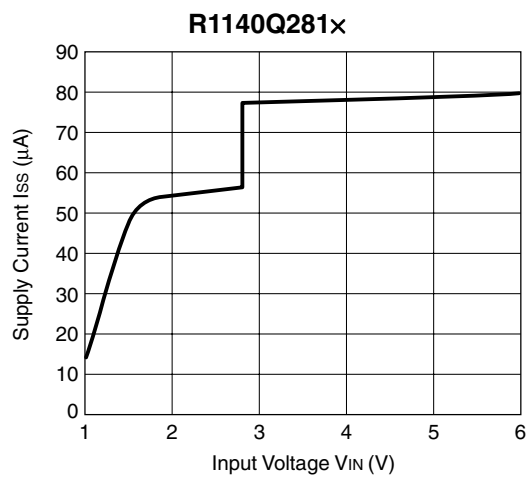
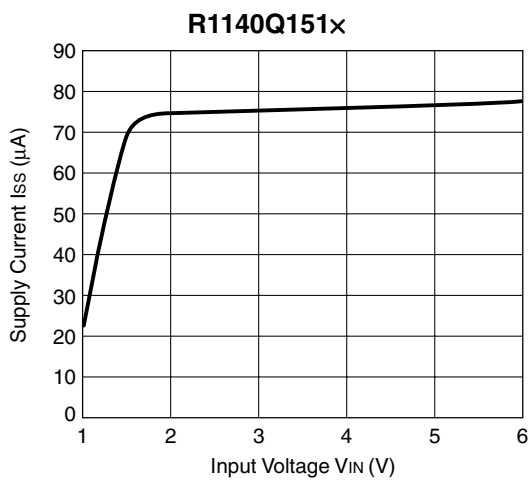

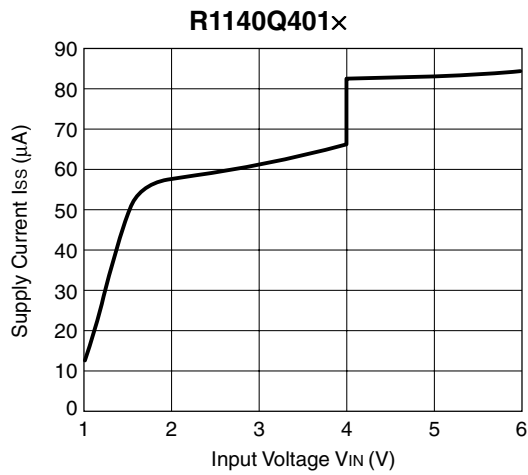

6) Supply Current vs. Temperature

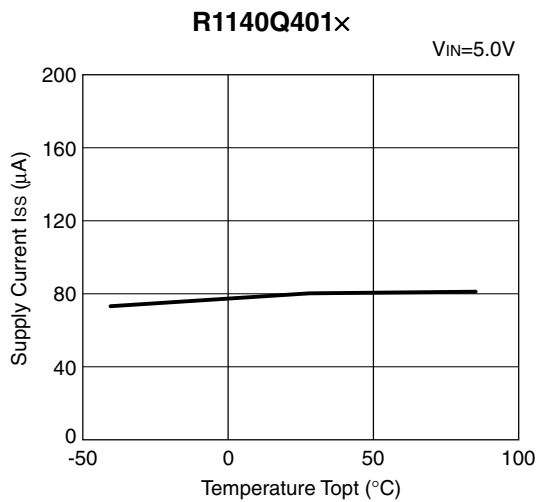
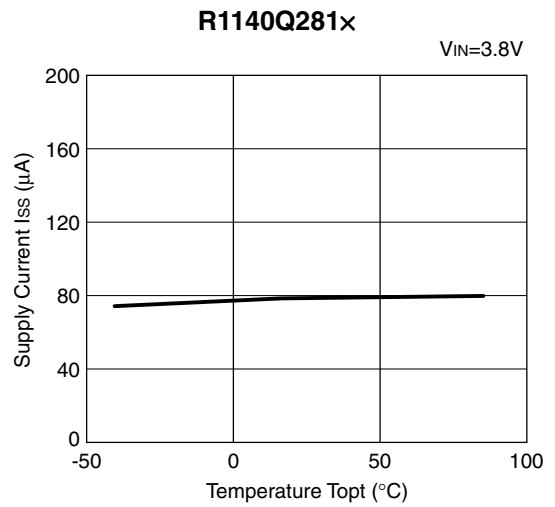
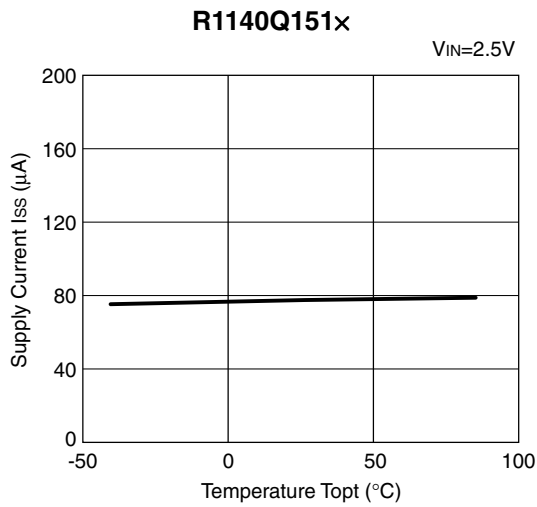

7) Dropout Voltage vs. Set Output Voltage

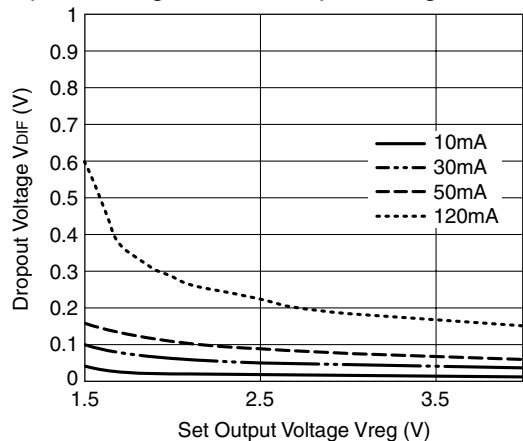

8) Ripple Rejection vs. Frequency

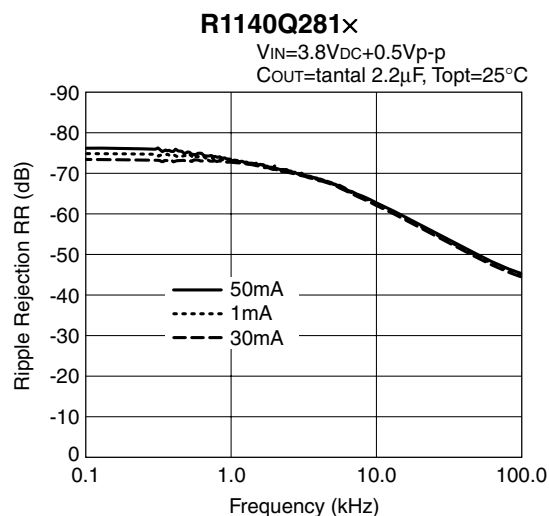
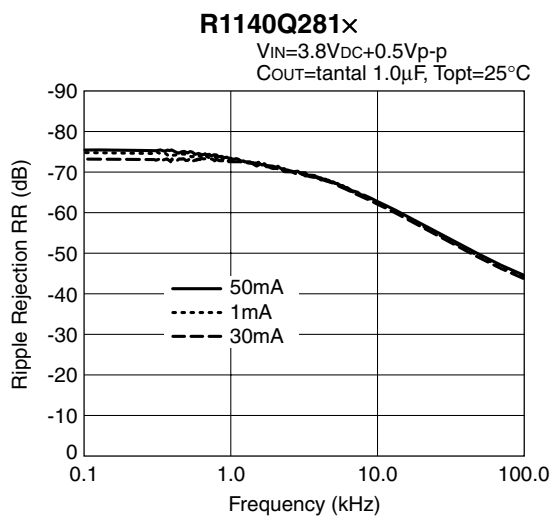
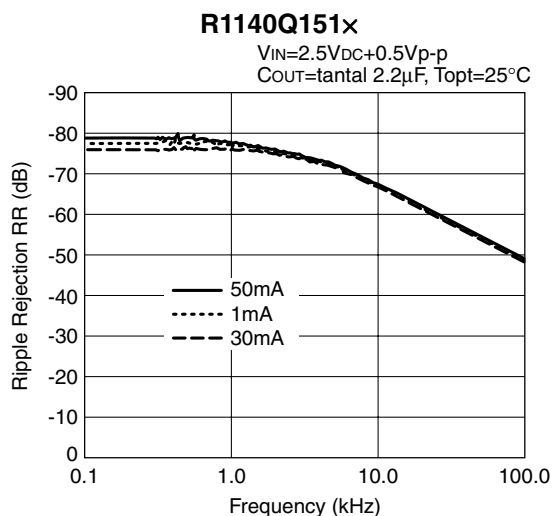
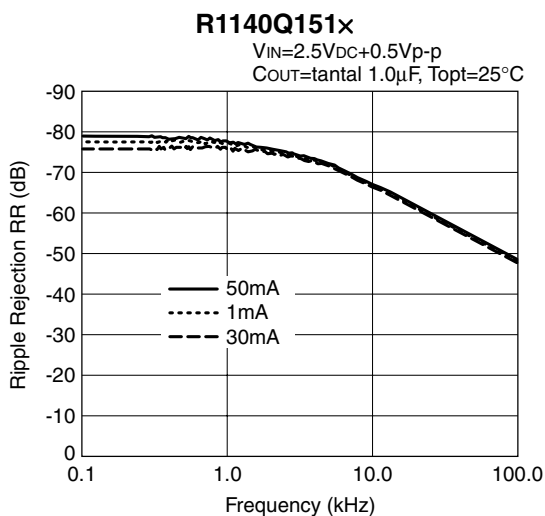

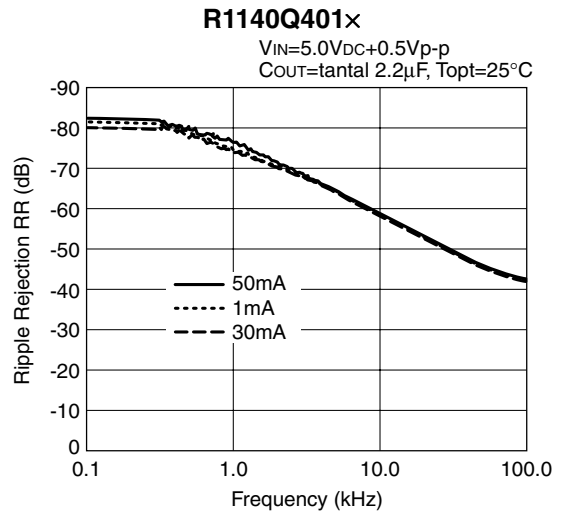
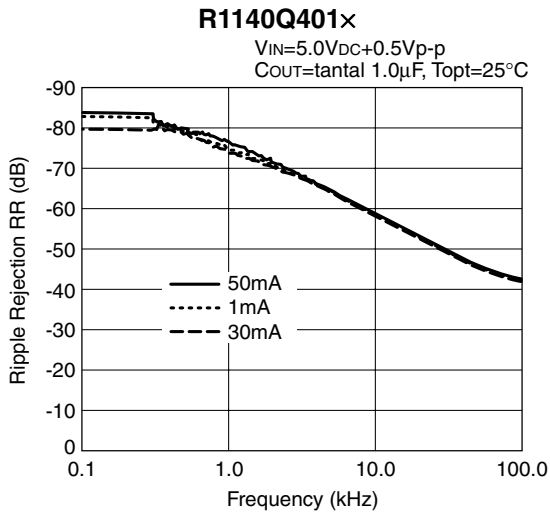

9) Ripple Rejection vs. Input Bias

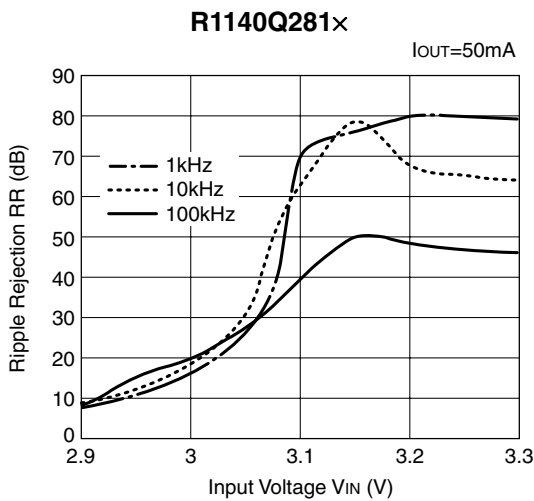
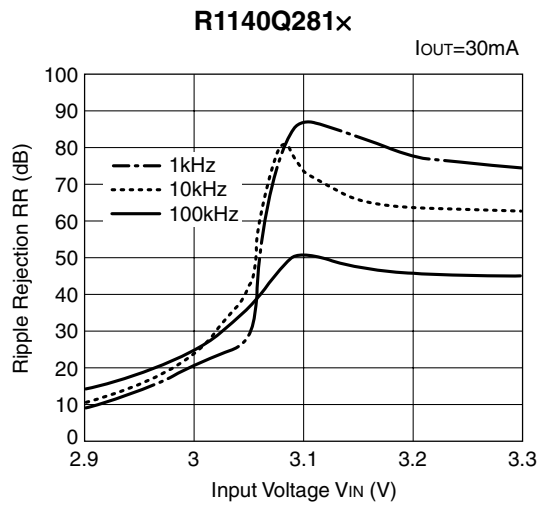
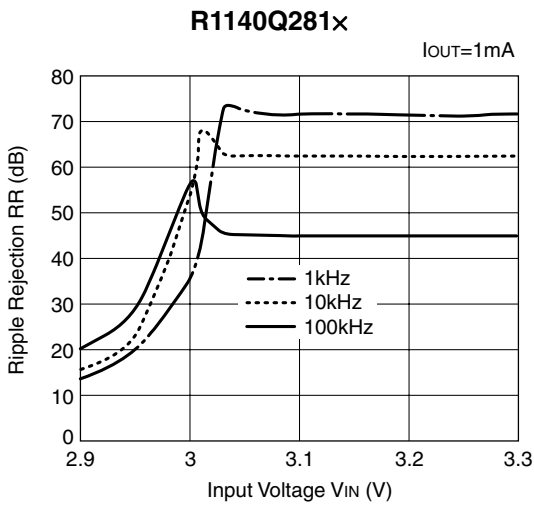

10) Input Transient Response

R1140Q281x

$V_{IN}=3.8V \leftrightarrow 4.8V$ ,  $t_r=t_f=5\mu s$   
 $C_{OUT}=\text{tantal } 1.0\mu F$ ,  $I_{OUT}=30mA$

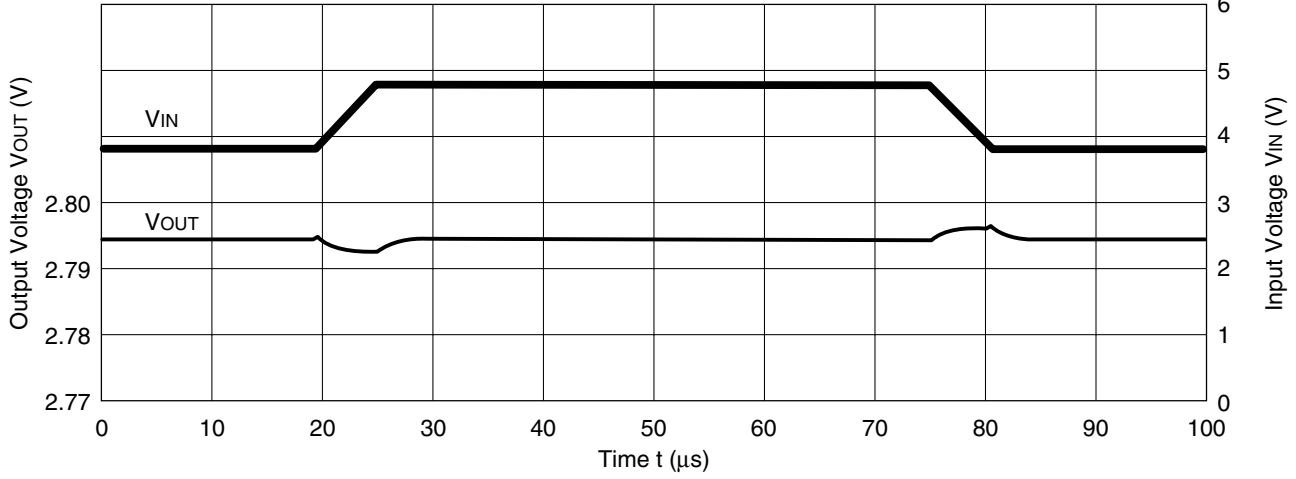

R1140Q281x

$V_{IN}=3.8V \leftrightarrow 4.8V$ ,  $t_r=t_f=5\mu s$   
 $C_{OUT}=\text{tantal } 2.2\mu F$ ,  $I_{OUT}=30mA$

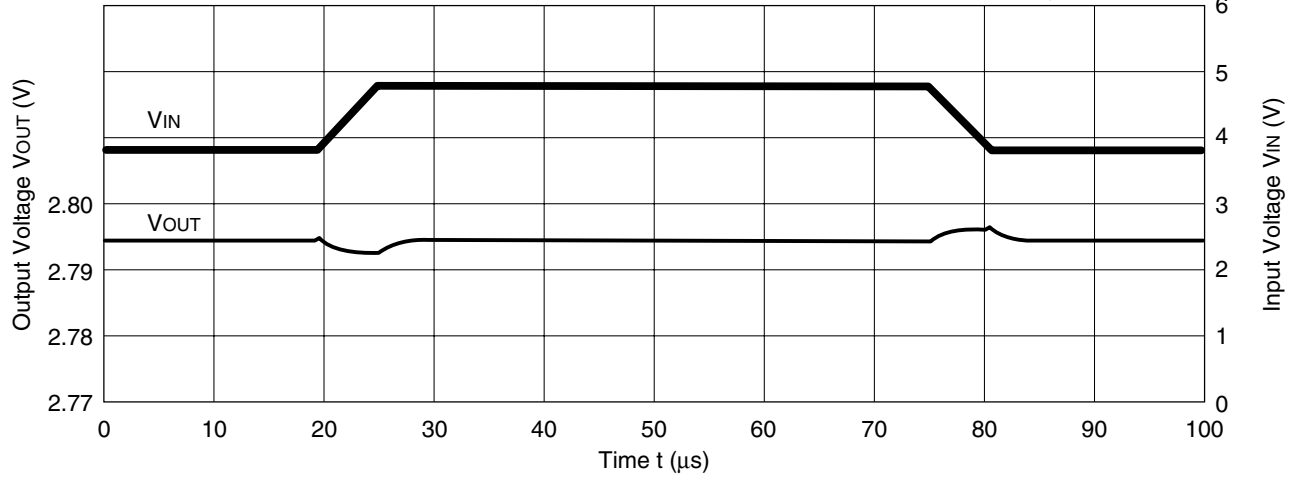

R1140Q281x

V<sub>IN</sub>=3.8V↔4.8V, tr=tf=5μs  
C<sub>OUT</sub>=tantal 6.8μF, I<sub>OUT</sub>=30mA

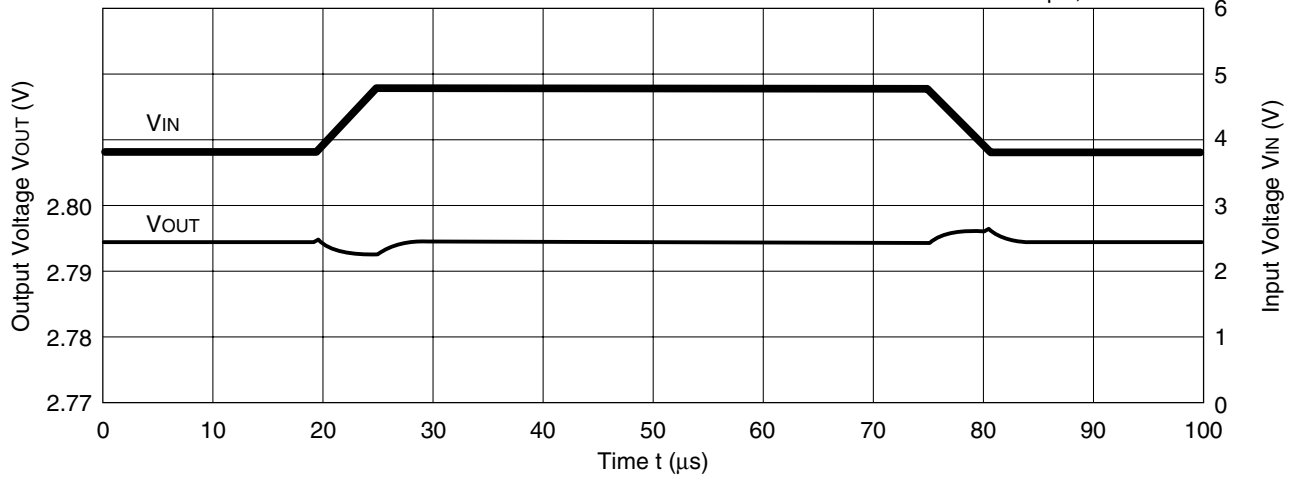

11) Load Transient Response

R1140Q281x

V<sub>IN</sub>=3.8V, C<sub>IN</sub>=tantal 1.0μF  
C<sub>OUT</sub>=tantal 1.0μF

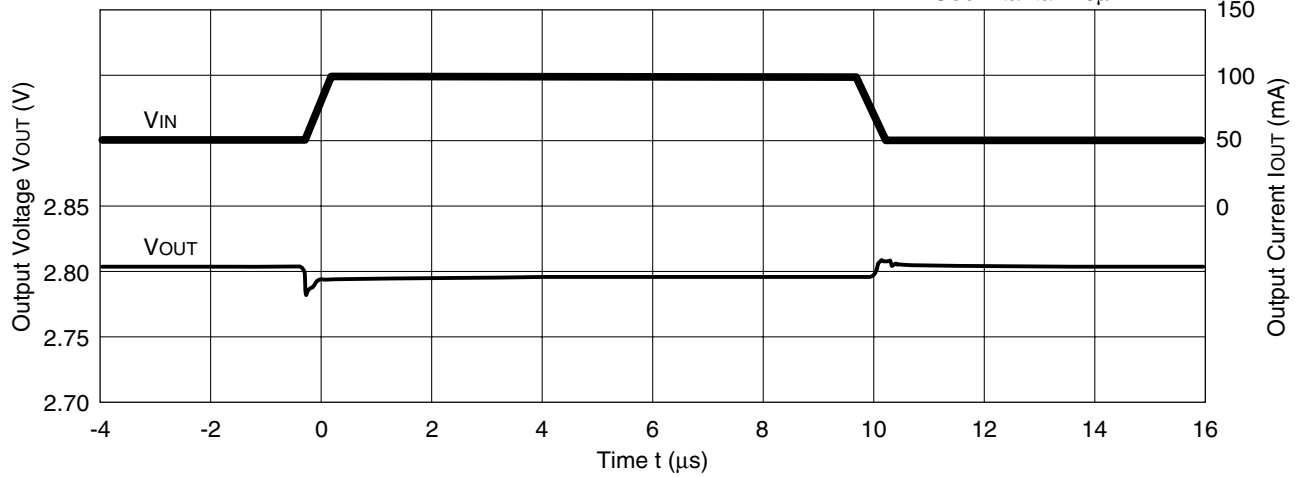



R1140Q281x

V<sub>IN</sub>=3.8V, C<sub>IN</sub>=tantal 1.0μF  
C<sub>OUT</sub>=tantal 2.2μF

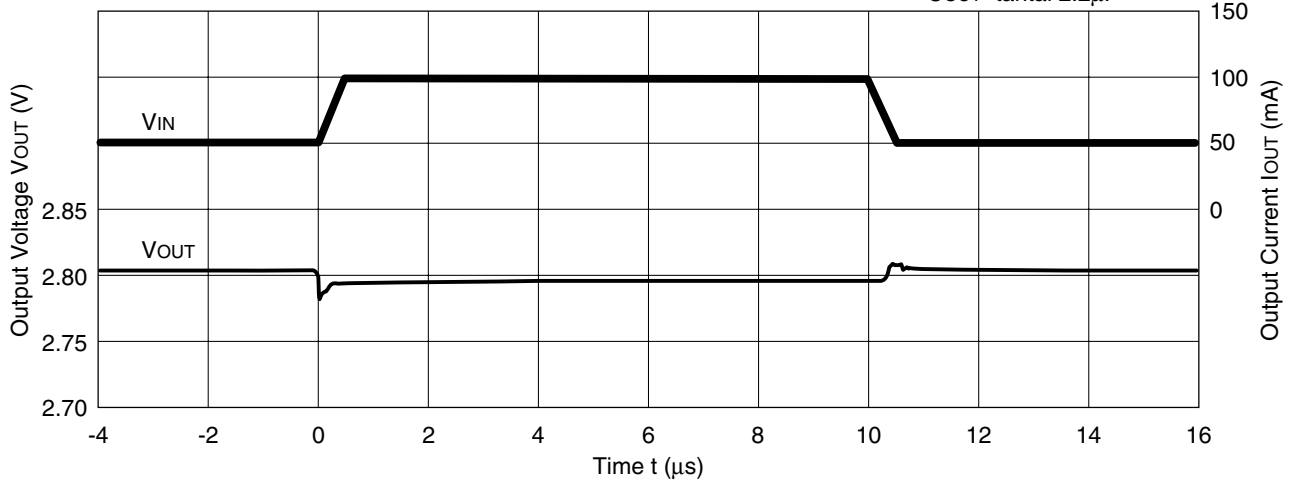

R1140Q281x

V<sub>IN</sub>=3.8V, C<sub>IN</sub>=tantal 1.0μF  
C<sub>OUT</sub>=tantal 6.8μF

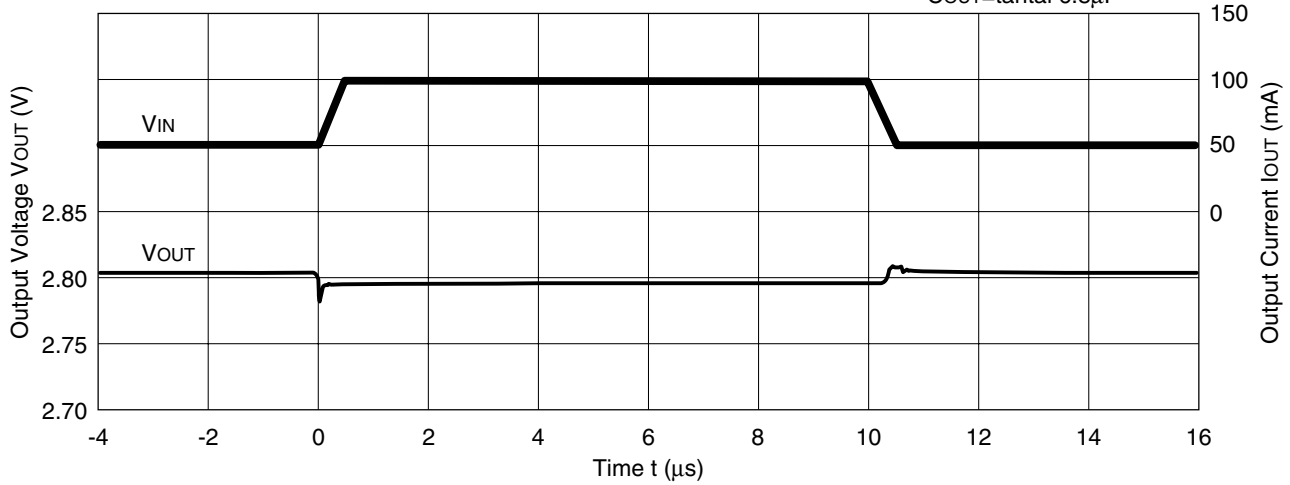

## TECHNICAL NOTES

When using these ICs, consider the following points:

In these ICs, phase compensation is made for securing stable operation even if the load current is varied. For this purpose, be sure to use a capacitor  $C_{OUT}$  with good frequency characteristics and ESR (Equivalent Series Resistance) of which is in the range described as follows:

The relations between  $I_{OUT}$  (Output Current) and ESR of Output Capacitor are shown below. The conditions when the white noise level is under  $40\mu\text{V}$  (Avg.) are marked as the hatched area in the graph.

< Test conditions >

- (1)  $V_{IN} = 3.8\text{V}$
- (2) Frequency band: 10Hz to 2MHz
- (3) Temperature:  $25^\circ\text{C}$

