

## High Sensitivity, Bialkali Photocathode 28mm (1-1/8 Inch) Diameter, 9-Stage, Side-On Type

### FEATURES

#### ● Spectral Response

R3788 .....	185 to 750 nm
R4332 .....	160 to 750 nm

#### ● High Cathode Sensitivity

Luminous .....	120 $\mu$ A/lm Typ.
Radiant at 420nm .....	90mA/W Typ.
Quantum Efficiency at 210nm .....	40% Typ. (R4332)

#### ● High Anode Sensitivity (at 1000V)

Luminous .....	1200A/lm Typ.
Radiant at 420nm .....	9.0 $\times 10^5$ A/W Typ.

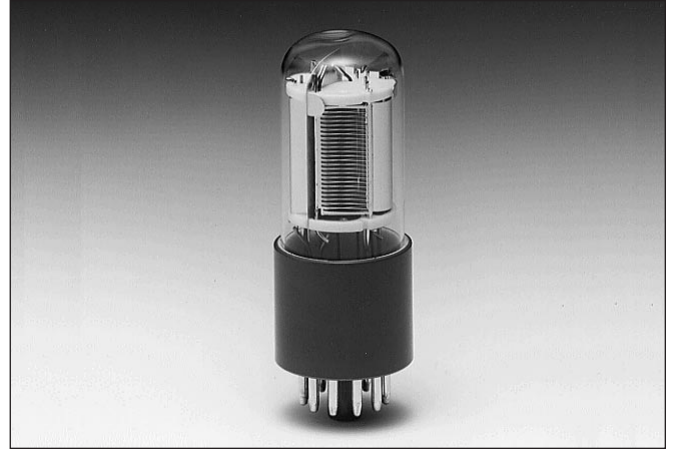

### APPLICATIONS

- Fluorescence Spectrophotometers
- Emission Spectrophotometers
- Atomic Absorption Spectrophotometers

### GENERAL

Parameter	Description	Unit
Spectral Response		
R3788	185 to 750	nm
R4332	160 to 750	nm
Wavelength of Maximum Response	420	nm
Photocathode		
Material	Bialkali	—
Minimum Effective Area	8 $\times$ 24	mm
Window Material		
R3788	UV glass	—
R4332	Fused silica	—
Dynode		
Secondary Emitting Surface	Bialkali	—
Structure	Circular-cage	—
Number of Stages	9	—
Direct Interelectrode Capacitances		
Anode to Last Dynode	4	pF
Anode to All Other Electrodes	6	pF
Base	11-pin base JEDEC No. B11-88	—
Weight	45	g
Suitable Socket	E678-11A (option)	—
Suitable Socket Assembly	E717-21(option)	—

Figure 1: Typical Spectral Response

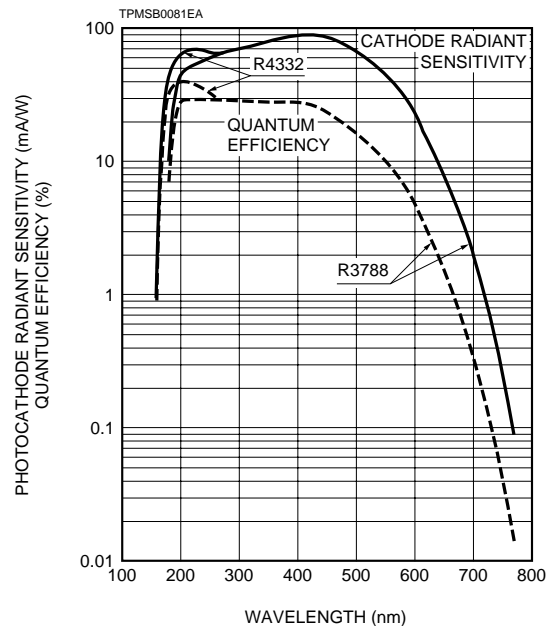

Subject to local technical requirements and regulations, availability of products included in this promotional material may vary. Please consult with our sales office.

Information furnished by HAMAMATSU is believed to be reliable. However, no responsibility is assumed for possible inaccuracies or omissions. Specifications are subject to change without notice. No patent rights are granted to any of the circuits described herein. © 1994 Hamamatsu Photonics K.K.

# PHOTOMULTIPLIER TUBES R3788, R4332

## MAXIMUM RATINGS (Absolute Maximum Values)

Parameter	Value	Unit
Supply Voltage		
Between Anode and Cathode	1250	Vdc
Between Anode and Last Dynode	250	Vdc
Average Anode Current <sup>A</sup>	0.1	mA

## CHARACTERISTICS (at 25°C)

Parameter	R3788			R4332			Unit
	Min.	Typ.	Max.	Min.	Typ.	Max.	
Cathode Sensitivity							
Quantum Efficiency at Peak Wavelength	—	30	—	—	40	—	%
		(at 250nm)			(at 210nm)		
Luminous <sup>B</sup>	100	120	—	100	120	—	μA/lm
Radiant at 194nm	—	31	—	—	60	—	mA/W
210nm	—	50	—	—	68	—	mA/W
420nm	—	90	—	—	90	—	mA/W
Red/White Ratio <sup>C</sup>	—	0.01	—	—	0.01	—	—
Blue <sup>D</sup>	—	10	—	—	10	—	μA/lm-b
Anode Sensitivity							
Luminous <sup>E</sup>	500	1200	—	500	1200	—	A/lm
Radiant at 194nm	—	3.1 × 10 <sup>5</sup>	—	—	6.0 × 10 <sup>5</sup>	—	A/W
210nm	—	5.0 × 10 <sup>5</sup>	—	—	6.8 × 10 <sup>5</sup>	—	A/W
420nm	—	9.0 × 10 <sup>5</sup>	—	—	9.0 × 10 <sup>5</sup>	—	A/W
Gain <sup>E</sup>	—	1.0 × 10 <sup>7</sup>	—	—	1.0 × 10 <sup>7</sup>	—	—
Anode Dark Current <sup>F</sup>	—	5	50	—	5	50	nA
(After 30minutes Storage in the darkness)							
ENI(Equivalent Noise Input) <sup>G</sup>	—	1.4 × 10 <sup>-16</sup>	—	—	1.4 × 10 <sup>-16</sup>	—	W
Time Response <sup>E</sup>							
Anode Pulse Rise Time <sup>H</sup>	—	2.2	—	—	2.2	—	ns
Electron Transit Time <sup>I</sup>	—	22	—	—	22	—	ns
Transit Time Spread (TTS) <sup>J</sup>	—	1.2	—	—	1.2	—	ns
Anode Current Stability <sup>K</sup>							
Light Hysteresis	—	0.1	—	—	0.1	—	%
Voltage Hysteresis	—	1.0	—	—	1.0	—	%

## NOTES

A: Averaged over any interval of 30 seconds maximum.

B: The light source is a tungsten filament lamp operated at a distribution temperature of 2856K. Supply voltage is 100 volts between the cathode and all other electrodes connected together as anode.

C: Red/White ratio is the quotient of the cathode current measured using a red filter(Toshiba R-68) interposed between the light source and the tube by the cathode current measured with the filter removed under the same conditions as Note B.

D: The value is cathode output current when a blue filter(Corning CS-5-58 polished to 1/2 stock thickness) is interposed between the light source and the tube under the same condition as Note B.

E: Measured with the same light source as Note B and with the voltage distribution ratio shown in Table 1 below.

Table 1: Voltage Distribution Ratio

Electrodes	K	Dy1	Dy2	Dy3	Dy4	Dy5	Dy6	Dy7	Dy8	Dy9	P
Distribution Ratio	1	1	1	1	1	1	1	1	1	1	1

Supply Voltage : 1000Vdc

K : Cathode, Dy : Dynode, P : Anode

F: Measured with the same supply voltage and voltage distribution ratio as Note E after removal of light.

G: ENI is an indication of the photon-limited signal-to-noise ratio. It refers to the amount of light in watts to produce a signal-to-noise ratio of unity in the output of a photomultiplier tube.

$$ENI = \frac{\sqrt{2q \cdot I_{db} \cdot G \cdot \Delta f}}{S}$$

where q = Electronic charge (1.60 × 10<sup>-19</sup> coulomb).

I<sub>db</sub> = Anode dark current(after 30 minutes storage) in amperes.

G = Gain.

Δf = Bandwidth of the system in hertz. 1 hertz is used.

S = Anode radiant sensitivity in amperes per watt at the wavelength of peak response.

H: The rise time is the time for the output pulse to rise from 10% to 90% of the peak amplitude when the entire photocathode is illuminated by a delta function light pulse.

I: The electron transit time is the interval between the arrival of delta function light pulse at the entrance window of the tube and the time when the anode output reaches the peak amplitude. In measurement, the whole photocathode is illuminated.

J: Also called transit time jitter. This is the fluctuation in electron transit time between individual pulses in the signal photoelectron mode, and may be defined as the FWHM of the frequency distribution of electron transit times.

K: Hysteresis is temporary instability in anode current after light and voltage are applied.

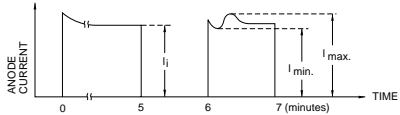

TPMSB0002EA

**Figure 2: Anode Luminous Sensitivity and Gain Characteristics**

$$\text{Hysteresis} = \frac{I_{\max} - I_{\min.}}{I_j} \times 100(\%)$$

(1)Current Hysteresis

The tube is operated at 750 volts with an anode current of 1 micro-ampere for 5 minutes. The light is then removed from the tube for a minute. The tube is then re-illuminated by the previous light level for a minute to measure the variation.

(2)Voltage Hysteresis

The tube is operated at 300 volts with an anode current of 0.1 micro-ampere for 5 minutes. The light is then removed from the tube and the supply voltage is quickly increased to 800 volts. After a minute, the supply voltage is then reduced to the previous value and the tube is re-illuminated for a minute to measure the variation.

**Figure 3: Typical Time Response**

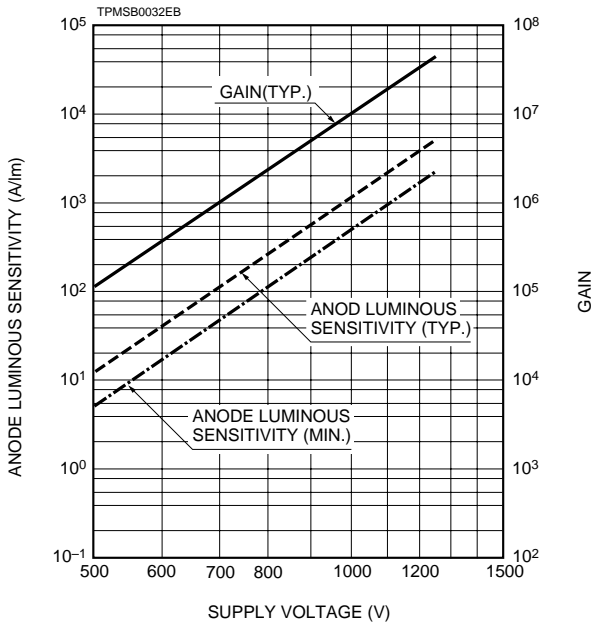

**Figure 4: Typical ENI with Wavelength**

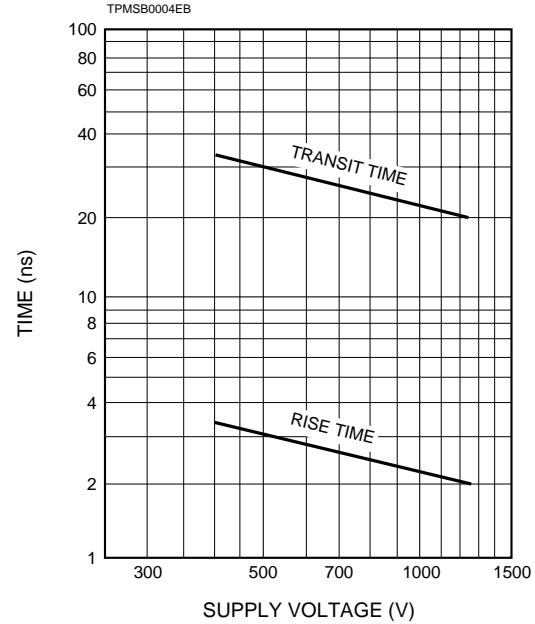

**Figure 5: Typical EADCI (Equivalent Anode Dark Current Input) vs. Supply Voltage**

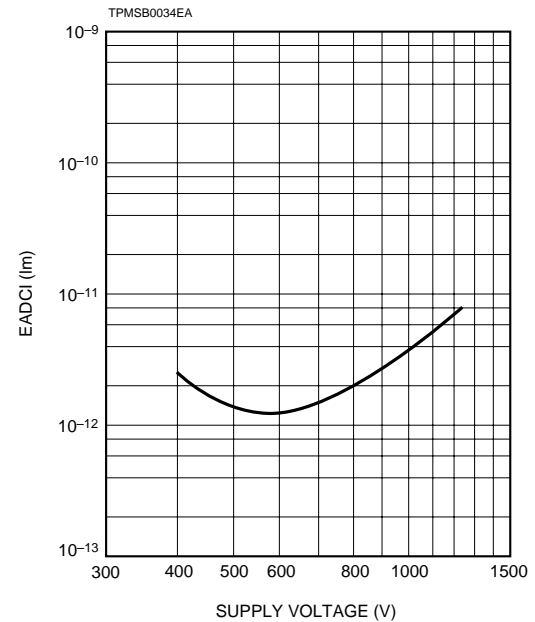
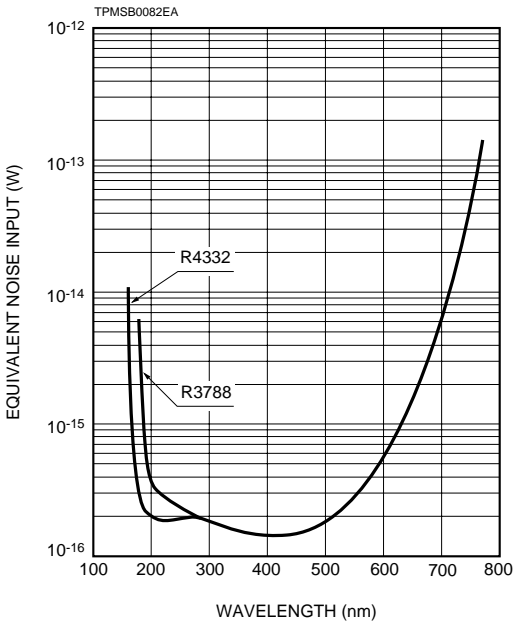

# PHOTOMULTIPLIER TUBES R3788, R4332

Unit : mm

Figure 6: Dimensional Outline and Basing Diagram

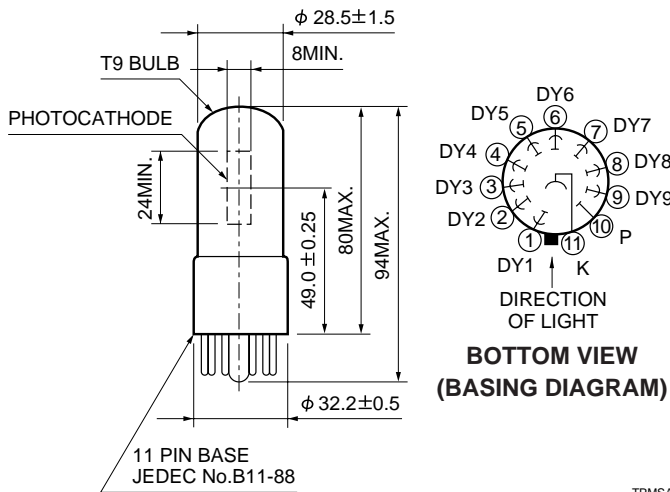

TPMSA0005EB

Figure 7: Socket E678-11A (Option)

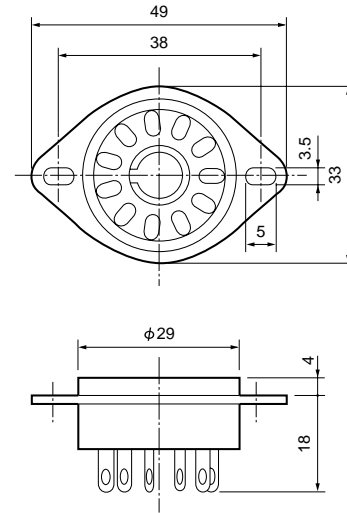

TACCA0008EB

Figure 8: D Type Socket Assembly E717-21 (Option)

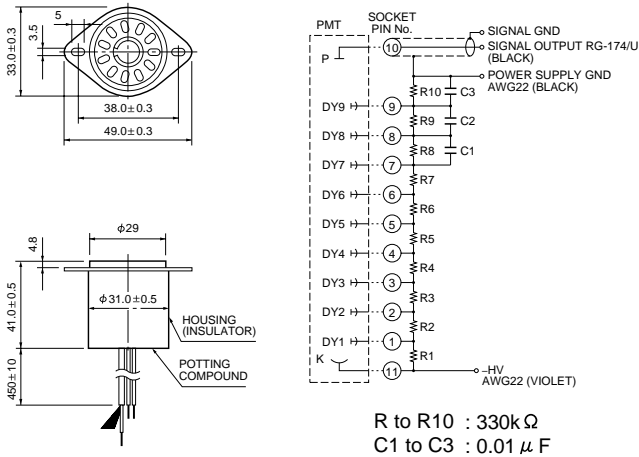

R to R10 : 330kΩ  
C1 to C3 : 0.01 μF

TACCA0002ED

※ Hamamatsu also provides C4900 series compact high voltage power supplies and C6270 series DP type socket assemblies which incorporate a DC to DC converter type high voltage power supply.

**Warning—Personal Safety Hazards**  
Electrical Shock—Operating voltages applied to this device present a shock hazard.

# HAMAMATSU

HAMAMATSU PHOTONICS K.K., Electron Tube Center

314-5, Shimokanzo, Toyooka-village, Iwata-gun, Shizuoka-ken, 438-0193, Japan, Telephone: (81)539/62-5248, Fax: (81)539/62-2205

U.S.A.: Hamamatsu Corporation: 360 Foothill Road, Bridgewater, N.J. 08807-0910, U.S.A., Telephone: (1)908-231-0960, Fax: (1)908-231-1218

Germany: Hamamatsu Photonics Deutschland GmbH: Arzbergerstr. 10, D-82211 Herrsching am Ammersee, Germany, Telephone: (49)8152-375-0, Fax: (49)8152-2658

France: Hamamatsu Photonics France S.A.R.L.: 8, Rue du Saule Trapu, Parc du Moulin de Massy, 91882 Massy Cedex, France, Telephone: (33)1 69 53 71 00, Fax: (33)1 69 53 71 10

United Kingdom: Hamamatsu Photonics UK Limited: Lough Point, 2 Gladbeck Way, Windmill Hill, Enfield, Middlesex EN2 7JA, United Kingdom, Telephone: (44)181-367-3560, Fax: (44)181-367-6384

North Europe: Hamamatsu Photonics Norden AB: Färögatan 7, S-164-40 Kista Sweden, Telephone: (46)8-703-29-50, Fax: (46)8-750-58-95

Italy: Hamamatsu Photonics Italia: S.R.L.: Via Della Moia, 1/E, 20020 Arese, (Milano), Italy, Telephone: (39)2-935 81 733, Fax: (39)2-935 81 741

TPMS1021E01  
FEB. 1994