

Very High Cathode Sensitivity with Low Noise Photocathode

FEATURES

- Spectral Response 185 to 710 nm
- High Cathode Sensitivity
 - Luminous 100 μ A/lm
 - Radiant at 410nm 70 mA/W
- High Anode Sensitivity (at 1000V)
 - Luminous 1200A/lm
 - Radiant at 410nm 8.4×10^5 A/W
- Low Dark Current 0.2nA
- Low Dark Counts (R4220P) 10 cps

Hamamatsu R4220 features extremely high cathode sensitivity, high Gain, and low dark current.

Variant tube (R4220P) specially selected for photon counting application is also available.

The R4220 is useful for fluorescence, chemiluminescence, Raman spectroscopy and low light level detection.



GENERAL

Parameter	Description/Value	Unit
Spectral Response	185 to 710	nm
Wavelength of Maximum Response	410	nm
Photocathode Material	Low noise bialkali	—
Minimum Effective Area	8 × 24	mm
Window Material	UV glass	—
Dynode Secondary Emitting Surface Structure	Low noise bialkali Circular-cage	—
Number of Stages	9	—
Direct Interelectrode Capacitances		
Anode to Last Dynode	4	pF
Anode to All Other Electrodes	6	pF
Base	11-pin base JEDEC No. B11-88	—
Weight	45	g
Suitable Socket	E678-11A (option)	—
Suitable Socket Assembly	E717-21 (option)	—

Figure 1: Typical Spectral Response

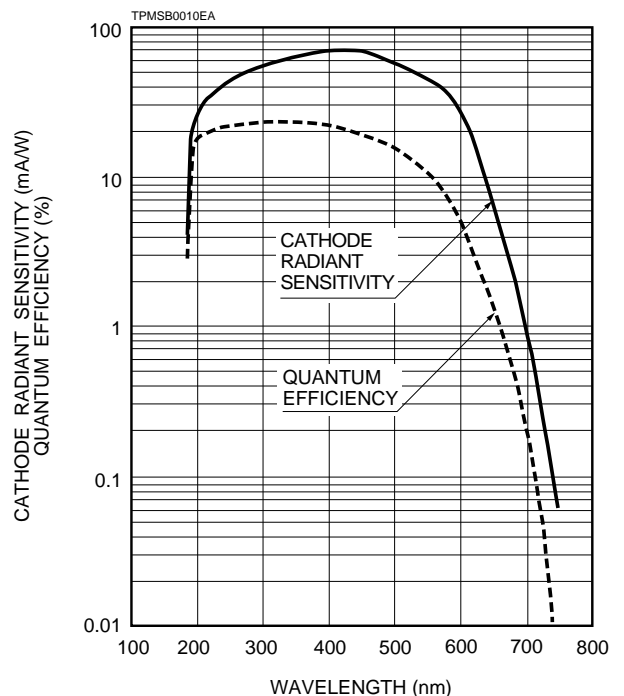

PHOTOMULTIPLIER TUBES R4220, R4220P (For Photon Counting)

MAXIMUM RATINGS (Absolute Maximum Values)

Parameter	Value	Unit
Supply Voltage		
Between Anode and Cathode	1250	Vdc
Between Anode and Last Dynode	250	Vdc
Average Anode Current ^A	0.1	mA

CHARACTERISTICS (at 25°C)

Parameter	R4220 for General Purpose			R4220P for Photon Counting			Unit
	Min.	Typ.	Max.	Min.	Typ.	Max.	
Cathode Sensitivity							
Quantum Efficiency at 300nm (Peak)	—	23	—	—	23	—	%
Luminous ^B	80	100	—	80	100	—	μA/lm
Radiant at 410nm (Peak)	—	70	—	—	70	—	mA/W
Blue ^C	—	8	—	—	8	—	μA/lm-b
Anode Sensitivity							
Luminous ^D	1000	1200	—	1000	1200	—	A/lm
Radiant at 400nm	—	8.4 × 10 ⁵	—	—	8.4 × 10 ⁵	—	A/W
Gain ^E	—	1.2 × 10 ⁷	—	—	1.2 × 10 ⁷	—	
Anode Dark Current ^F							
After 30minutes Storage in the darkness	—	0.2	2.0	—	0.2	0.5	nA
Anode Dark Counts ^F	—	—	—	—	10	50	cps
ENI(Equivalent Noise Input) ^G	—	3.30 × 10 ⁻¹⁷	—	—	3.30 × 10 ⁻¹⁷	—	W
Time Response ^D							
Anode Pulse Rise Time ^H	—	2.2	—	—	2.2	—	ns
Electron Transit Time ^J	—	22	—	—	22	—	ns
Transit Time Spread (TTS) ^K	—	1.2	—	—	1.2	—	ns
Anode Current Stability ^L							
Current Hysteresis	—	0.1	—	—	0.1	—	%
Voltage Hysteresis	—	1.0	—	—	1.0	—	%

NOTES

- A: Averaged over any interval of 30 seconds maximum.
 B: The light source is a tungsten filament lamp operated at a distribution temperature of 2856K. Supply voltage is 150 volts between the cathode and all other electrodes connected together as anode.
 C: The value is cathode output current when a blue filter(Corning CS-5-58 polished to 1/2 stock thickness) is interposed between the light source and the tube under the same condition as Note B.
 D: Measured with the same light source as Note B and with the anode-to-cathode supply voltage and voltage distribution ratio shown in Table 1 below.
 E: Measured with the same supply voltage and voltage distribution ratio as Note D after removal of light.
 F: Measured at the voltage producing the gain of 1 × 10⁶.
 G: ENI is an indication of the photon-limited signal-to-noise ratio. It refers to the amount of light in watts to produce a signal-to-noise ratio of unity in the output of a photomultiplier tube.

$$ENI = \frac{\sqrt{2q \cdot ldb \cdot G \cdot f}}{S}$$

- where q = Electronic charge (1.60 × 10⁻¹⁹ coulomb).
 ldb = Anode dark current(after 30 minute storage) in amperes.
 G = Gain.
 f = Bandwidth of the system in hertz. 1 hertz is used.
 S = Anode radiant sensitivity in amperes per watt at the wavelength of peak response.

- H: The rise time is the time for the output pulse to rise from 10% to 90% of the peak amplitude when the entire photocathode is illuminated by a delta function light pulse.
 J: The electron transit time is the interval between the arrival of delta function light pulse at the entrance window of the tube and the time when the anode output reaches the peak amplitude. In measurement, the whole photocathode is illuminated.

- K: Also called transit time jitter. This is the fluctuation in electron transit time between individual pulses in the signal photoelectron mode, and may be defined as the FWHM of the frequency distribution of electron transit times.
 L: Hysteresis is temporary instability in anode current after light and voltage are applied.

$$\text{Hysteresis} = \frac{I_{\max} - I_{\min}}{I_i} \times 100(\%)$$

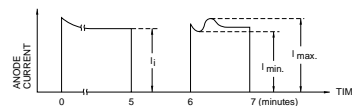

TPMSB0002EA

(1)Current Hysteresis

The tube is operated at 750 volts with an anode current of 1 micro-ampere for 5 minutes. The light is then removed from the tube for a minute. The tube is then re-illuminated by the previous light level for a minute to measure the variation.

(2)Voltage Hysteresis

The tube is operated at 300 volts with an anode current of 0.1 micro-ampere for 5 minutes. The light is then removed from the tube and the supply voltage is quickly increased to 800 volts. After a minute, the supply voltage is then reduced to the previous value and the tube is re-illuminated for a minute to measure the variation.

Table 1: Voltage Distribution Ratio

Electrodes	K	Dy1	Dy2	Dy3	Dy4	Dy5	Dy6	Dy7	Dy8	Dy9	P
Distribution Ratio	1	1	1	1	1	1	1	1	1	1	1

Supply Voltage : 1000Vdc

K : Cathode, Dy : Dynode, P : Anode

Figure 2: Typical Gain and Anode Dark Current

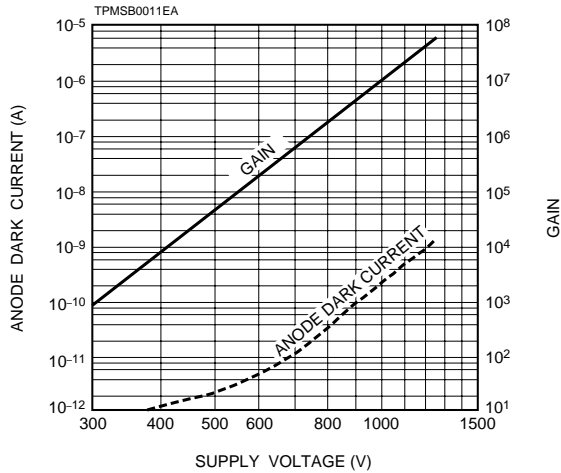

Figure 3: Typical Time Response

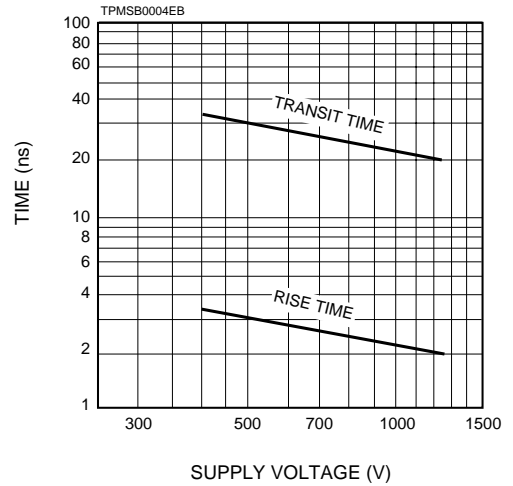

Figure 4: Typical ENI vs. Wavelength

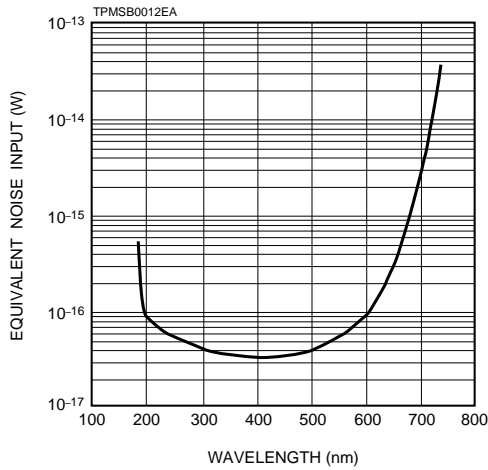
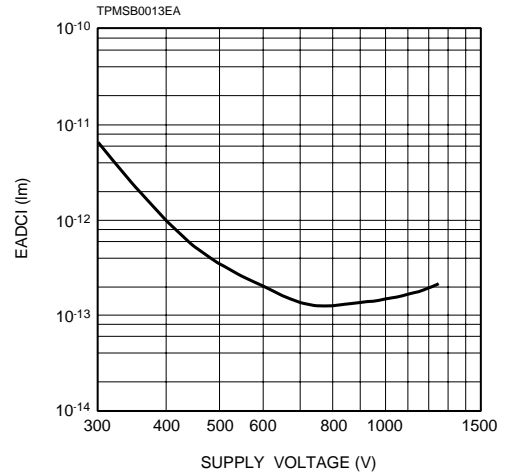

Figure 5: Typical EADCI (Equivalent Anode Dark Current Input) vs. Supply Voltage



Data shown here, which is given from a relation among supply voltage, anode sensitivity and dark current, serves as a good reference in order to determine the most suitable supply voltage or its range.

Figure 6: Typical Single Photon Pulse Height Distribution for R4220P

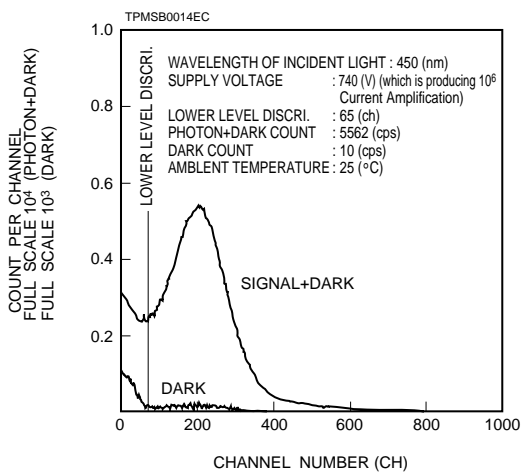
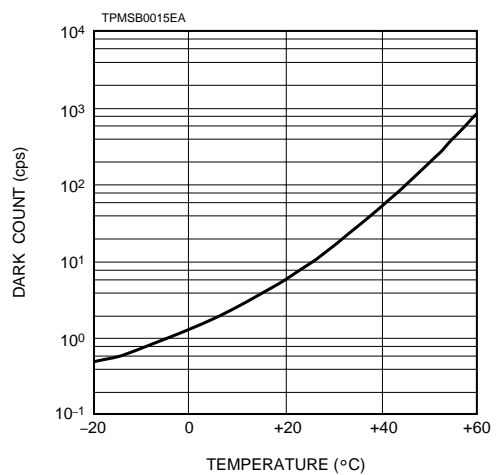

Figure 7: Typical Temperature Characteristics of Dark Count for R4220P



PHOTOMULTIPLIER TUBES R4220, R4220P (For Photon Counting)

Figure 8: Dimensional Outline and Basing Diagram(Unit: mm)

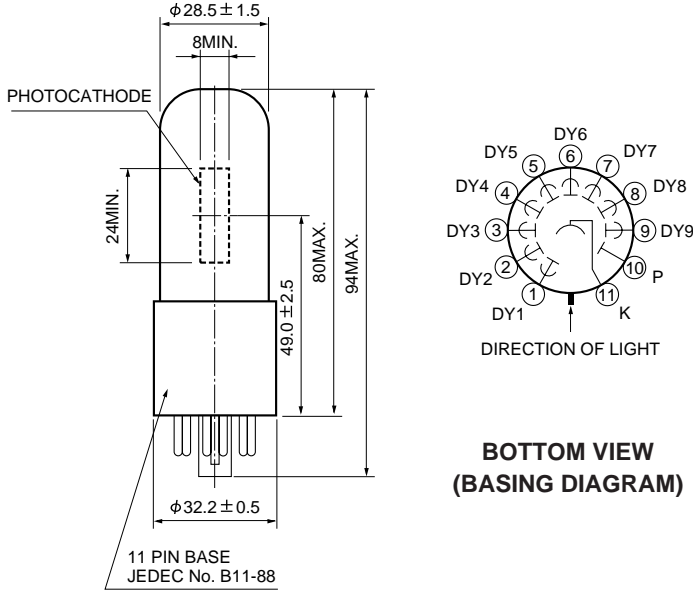
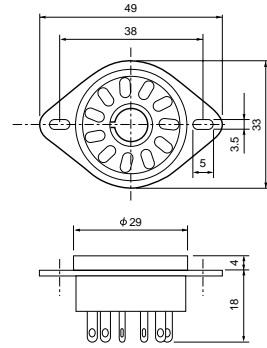

Figure 10: Socket E678-11A (Optional)



TACCA0064EA

TPMSA0001EA

Figure 9: D Type Socket Assembly E717-21 (Optional)

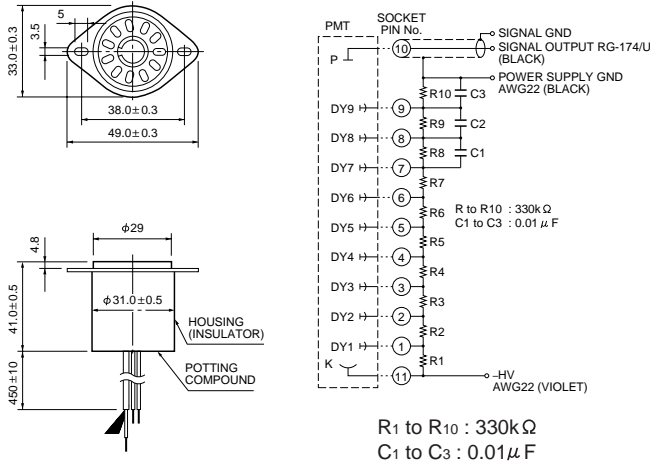

TACCA0002ED

※ Hamamatsu also provides C4900 series compact high voltage power supplies and C6270 series DP type socket assemblies which incorporate a DC to DC converter type high voltage power supply.

Warning—Personal Safety Hazards
Electrical Shock—Operating voltages applied to this device present a shock hazard.

HAMAMATSU

HAMAMATSU PHOTONICS K.K., Electron Tube Center

314-5, Shimokanzo, Toyooka-village, Iwata-gun, Shizuoka-ken, 438-0193, Japan, Telephone: (81)539/62-5248, Fax: (81)539/62-2205

U.S.A.: Hamamatsu Corporation: 360 Foothill Road, Bridgewater. N.J. 08807-0910, U.S.A., Telephone: (1)908-231-0960, Fax: (1)908-231-1218

Germany: Hamamatsu Photonics Deutschland GmbH: Arzbergerstr. 10, D-82211 Herrsching am Ammersee, Germany, Telephone: (49)8152-375-0, Fax: (49)8152-2658

France: Hamamatsu Photonics France S.A.R.L.: 8, Rue du Saule Trapu, Parc du Moulin de Massy, 91882 Massy Cedex, France, Telephone: (33)1 69 53 71 00, Fax: (33)1 69 53 71 10

United Kingdom: Hamamatsu Photonics UK Limited: Lough Point, 2 Gladbeck Way, Windmill Hill, Enfield, Middlesex EN2 7JA, United Kingdom, Telephone: (44)181-367-3560, Fax: (44)181-367-6384

North Europe: Hamamatsu Photonics Norden AB: Färögatan 7, S-164-40 Kista Sweden, Telephone: (46)8-703-29-50, Fax: (46)8-750-58-95

Italy: Hamamatsu Photonics Italia: S.R.L.: Via Della Moia, 1/E, 20020 Arese, (Milano), Italy, Telephone: (39)2-935 81 733, Fax: (39)2-935 81 741

TPMS1003E02
FEB. 1995