

Multi LDOs for Cellular-phone R5310L series

■ OUTLINE

The R5310L Series are Multi LDO regulators for power management of cellular phones. All of regulators are low noise and extremely low quiescent current by CMOS process. Each of these ICs consists of eight LDOs, voltage detectors, battery monitor, three LED drivers, and a ringer driver. Each of them can be controlled by CPU via 3-wire serial interface. These ICs make it possible to integrate almost power management and analog drivers in cellular-phone systems. The output voltage of two regulators are externally programmable, and other regulators are able to set different output voltage independently by laser trim as well as detector thresholds.

A tiny 32-pin LQFP, 0.5mm lead pitch, is available.

■ FEATURES

- Ultra Low Standby Current 10 μ A TYP. with only VR6 is enabled at no load
- High Accuracy Output Voltage and Detector Threshold $\pm 2.0\%$ except programmable VRs.
- Output Voltage and Detector Threshold Stepwise setting with a step of 0.1V is possible except programmable VRs.
- Low Temperature-Drift-Coefficients of Output Voltage and Detector Threshold TYP. 100ppm/ $^{\circ}$ C
- Low Dropout Voltage 150mV at 120mA for VR1
150mV at 80mA for VR2
- High Ripple Rejection 65dB at 1kHz for VR1, VR2 and VR5
60dB at 1kHz for VR6 and VR7
- 3-wire serial interface Shut-down for each of regulators, except VR6, detectors and drivers.
Adjusting output voltage for VR3/4 by 8 bit.
- Battery voltage monitor Analog output for monitoring battery voltage
- Package LQFP 32pin with 0.5mm lead pitch

■ APPLICATIONS

Portable Phones such as GSM, PDC and CDMA as well as other analog phones.
Power supply for battery-powered appliances.

■ BLOCK DIAGRAM

● R5310L001B

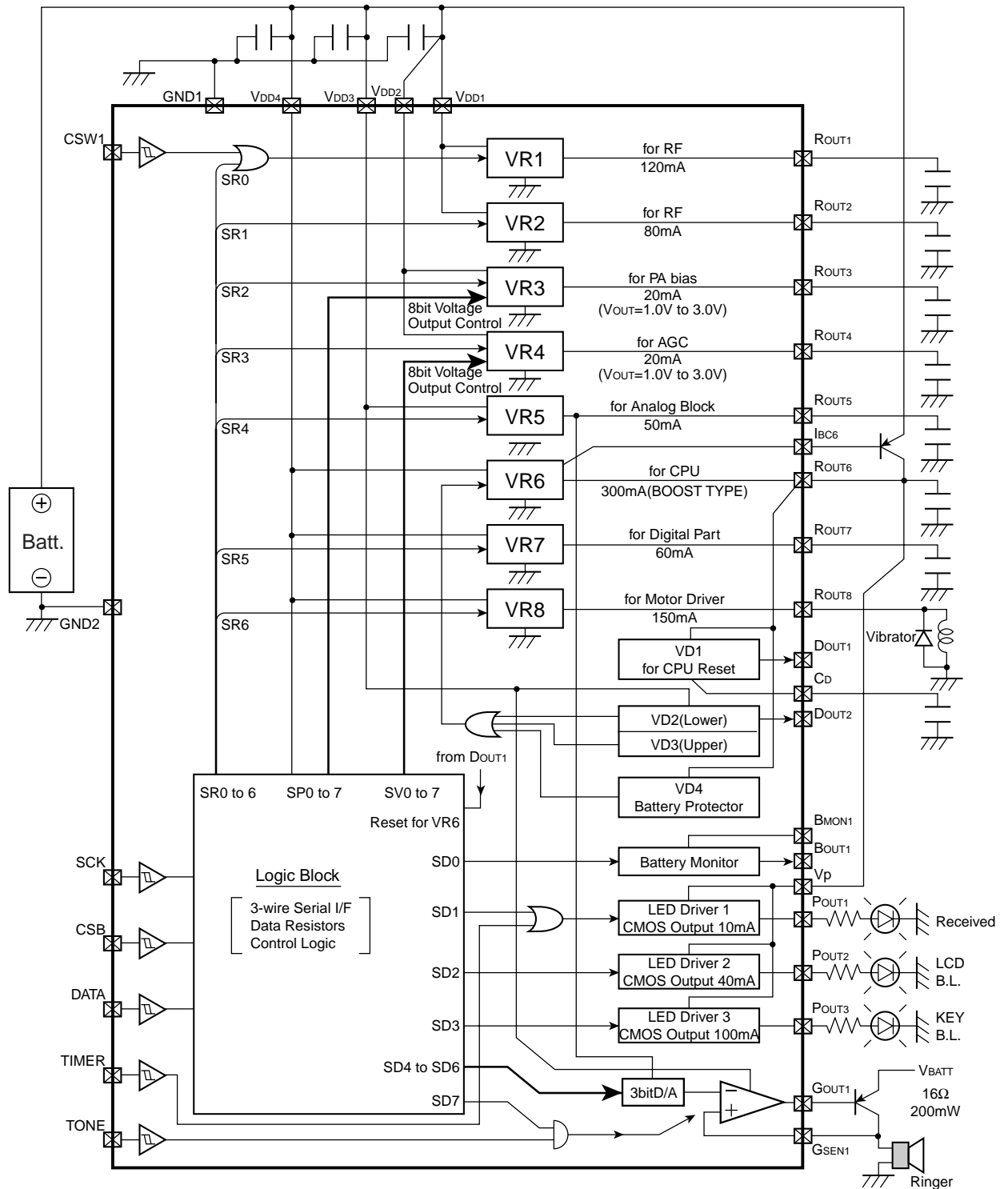

SELECTION GUIDE

In the R5310LXXXX series, Voltage settings for eight Regulators and three Detectors can be designates. Part Number is designated as follows:

R5310LXXX X ←Part Number
 ↑ ↑
 a b

Code	Descriptions
a	Serial Number for Voltage setting from zero to nine
b	Alphabetical Code for Mask Versions:

PIN CONFIGURATION

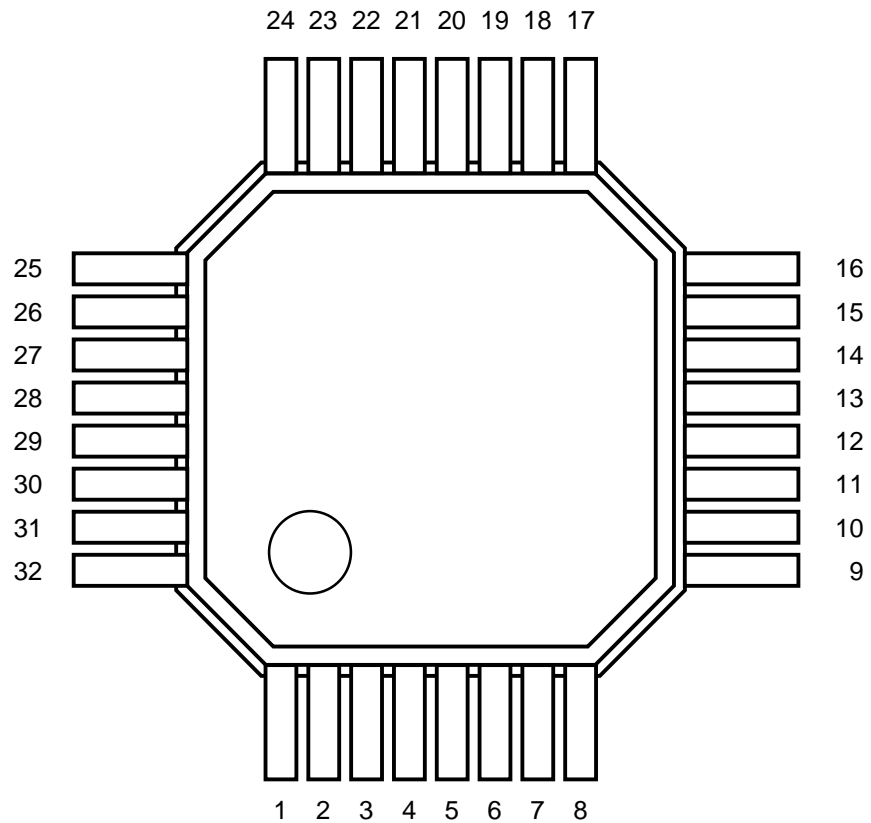

■ PIN DESCRIPTION

● R5310LXXXB

Pin No.	Symbol	Descriptions
1	V _{DD3}	Power supply for VR5, VR6, Battery Monitor, Ringer Driver
2	I _{BC6}	Connected to Base of external PNP transistor for Voltage Regulator6, VR6.
3	R _{OUT6}	Output pin for VR6. Connected to Collector of external PNP transistor.
4	R _{OUT7}	Output pin for VR7
5	V _{DD4}	Power supply for VR7, VR8, VD1, 2, 3, 4, Logic Block
6	R _{OUT8}	Output pin for VR8
7	G _{OUT1}	Output pin for a Ringer Driver
8	G _{SEN1}	Feedback pin a Ringer Driver
9	D _{OUT2}	Output pin for Voltage Detector2 and 3, VD2 and VD3. CMOS output.
10	C _D	Pin for an external capacitor for output delay time setting of VD1
11	D _{OUT1}	Output pin for VD1. CMOS output.
12	G _{ND2}	Ground
13	TIMER	Control switch input pin for PO1. Pulled down through resistor to the GND internally.
14	TONE	Input pin for Tone signal being from base band controller.
15	DATA	The DATA pin inputs written data in synchronization with shift clock pulses from the SCK pin.
16	SCK	The SCK pin is used to input shift clock pulses to synchronize data input to the DATA Pin.
17	CSB	The CSB pin is used to interface with the CPU and is accessible when held at the Low Level. Pulled up through internal resistor.
18	R _{OUT1}	Output pin for VR1
19	CSW1	Control switch input pin for VR1. Pulled down through 300kΩ to the GND internally.
20	V _{DD1}	Power supply for VR1, VR2
21	R _{OUT2}	Output pin for VR2
22	R _{OUT3}	Output pin for VR3
23	V _{DD2}	Power supply for VR3, VR4
24	R _{OUT4}	Output pin for VR4
25	P _{OUT3}	Output port for LED Driver3
26	P _{OUT1}	Output port for LED Driver1
27	V _p	Input pin of power supply for P _{OUT1} through P _{OUT3} being connected to the R _{OUT6} externally.
28	P _{OUT2}	Output port for LED Driver2
29	G _{ND1}	Ground
30	B _{OUT1}	Analog output for battery monitor
31	B _{MON1}	Sensing pin for battery monitor
32	R _{OUT5}	Output pin for VR5

■ ABSOLUTE MAXIMUM RATINGS

Symbol	Item	Conditions	Ratings	Unit
V _{DD}	Supply Voltage		6.5	V
V _{IN}	Input Voltage	CSB, SCK, DATA, CSW1/2/4, TONE	-0.3 to V _{DD} +0.3	V
I _{OUT1}	Output Current for VR1	R _{OUT1}	120	mA
I _{OUT2}	Output Current for VR2	R _{OUT2}	80	mA
I _{OUT3}	Output Current for VR3	R _{OUT3}	20	mA
I _{OUT4}	Output Current for VR4	R _{OUT4}	20	mA
I _{OUT5}	Output Current for VR5	R _{OUT5}	50	mA
I _{OUT7}	Output Current for VR7	R _{OUT7}	60	mA
I _{OUT8}	Output Current for VR8	R _{OUT8}	150	mA
I _{OUTP1}	Output Current for PO1	P _{OUT1}	10	mA
I _{OUTP2}	Output Current for PO2	P _{OUT2}	40	mA
I _{OUTP3}	Output Current for PO3	P _{OUT3}	100	mA
P _d	Power Dissipation	Mounted on a substrate T _{opt} =+25°C	1000	mW
		In the open air T _{opt} =+25°C	500	mW
T _{opt}	Operating Temperature		-40 to +85	°C
T _{stg}	Storage Temperature		-55 to +125	°C
T _{solder}	Soldering Temperature		260°C 10sec	

■ OVERALL CHARACTERISTICS

● R5310LXXXB series

Symbol	Item	Conditions	MIN.	TYP.	MAX.	Unit
V _{DD}	Operating Voltage		1.5 ^{Note4}		6.0	V
I _{standby}	Standby Current	All regulators are disabled except VR6 at no load		10	20	μA
R _{SET1}	Output Voltage setting range	for VR1	2.5		3.3	V
R _{SET2}	Output Voltage setting range	for VR2	2.5		3.3	V
R _{SET5}	Output Voltage setting range	for VR5	2.5		3.3	V
R _{SET6}	Output Voltage setting range	for VR6	2.5		3.3	V
R _{SET7}	Output Voltage setting range	for VR7	2.5		3.3	V
R _{SET8}	Output Voltage setting range	for VR8 compatible with 1.3V Vibrator	1.2		1.7	V
V _{SET1}	Detect Voltage setting range	for VD1, High to Low	1.2		3.3	V
V _{SET2}	Detect Voltage setting range	for VD2, High to Low	1.2		3.3	V
V _{SET3}	Reset Voltage setting range	for VD3, High to Low	5.3		6.6	V
V _{SET4}	Reset Voltage setting range	for VD4, High to Low	2.8		3.8	V

Note1: All of above setting voltages can be designated by user's requirement.

Note2: The Reset voltage is equal to the Detect Voltage in the VD3 and the VD4, because there is no hysteresis in the VD3.

Note3: Other options are available such as changing Output Voltage for VR3/4 or specifying Reset Voltage for VD1/2; contact Ricoh for details.

Note4: This value means the minimum operating voltage of VD1, VD2, VD3, and VD4.

■ ELECTRICAL CHARACTERISTICS

● R5310L001B

Voltage Regulator1/ VR1: 120mA output for RF / R5310L001B

T_{opt}=25°C

Symbol	Item	Conditions	MIN.	TYP.	MAX.	Unit
V _{ROUT1}	Output Voltage		2.94	3.00	3.06	V
V _{DIF1}	Dropout Voltage	I _{OUT1} =120mA		150	200	mV
I _{SS1}	Supply Current			40	80	μA
I _{lim1}	Current Limit	V _{ROUT1} =0V		60		mA
RR1	Ripple Rejection1	V _{DD} with sinusoidal 0.2V _{pp} , f=1kHz		65		dB
ΔV _{OUT1} /ΔI _{OUT}	Load Regulation	1mA≤I _{OUT1} ≤120mA			40	mV
ΔV _{OUT1} /ΔV _{IN}	Line Regulation	R _{OUT1} +0.2V≤V _{DD} ≤6.0V		0.05	0.2	%/V
ΔV _{OUT1} /ΔT _{opt}	Output Voltage Temperature Coefficient	-40°C≤T _{opt} ≤85°C		±100		ppm/°C

Unless otherwise provided, V_{DD}=3.6V I_{OUT1}=60mA.

Voltage Regulator2/ VR2: 80mA output for RF / R5310L001B

T_{opt}=25°C

Symbol	Item	Conditions	MIN.	TYP.	MAX.	Unit
V _{ROUT2}	Output Voltage		2.94	3.00	3.06	V
V _{DIF2}	Dropout Voltage	I _{OUT2} =80mA		150	200	mV
I _{SS2}	Supply Current			40	80	μA
I _{lim2}	Current Limit	V _{ROUT2} =0V		40		mA
RR2	Ripple Rejection2	V _{DD} with sinusoidal 0.2V _{pp} , f=1kHz		65		dB
ΔV _{OUT2} /ΔI _{OUT}	Load Regulation	1mA≤I _{OUT2} ≤80mA			40	mV
ΔV _{OUT2} /ΔV _{IN}	Line Regulation	R _{OUT2} +0.2V≤V _{DD} ≤6.0V		0.05	0.2	%/V
ΔV _{OUT2} /ΔT _{opt}	Output Voltage Temperature Coefficient	-40°C≤T _{opt} ≤85°C		±100		ppm/°C

Unless otherwise provided, V_{DD}=3.6V I_{OUT2}=40mA.

Voltage Regulator3/ VR3: 20mA programmable output via serial interface / R5310L001B

T_{opt}=25°C

Symbol	Item	Conditions	MIN.	TYP.	MAX.	Unit
V _{ROUT3Z}	Output Voltage with Zero Input	with Input code of decimal zero	0.94	1.0	1.06	V
V _{ROUT3F}	Output Voltage with Full Input	with Input code of decimal 255	2.9	3.0	3.1	V
DNL3	Differential Nonlinearity	Input code=0 to 255 in decimal	-1		+1	LSB
INL3	Integral Nonlinearity	Input code=0 to 255 in decimal	-2		+2	LSB
RES3	Output Voltage Resolution			8		bit
V _{DIF3}	Dropout Voltage	I _{OUT3} =20mA, Input code=255 in decimal		150	200	mV
I _{SS3}	Supply Current			250	400	μA
I _{lim3}	Current Limit	V _{ROUT3} =0V		20		mA
RR3	Ripple Rejection3	V _{DD} with sinusoidal 0.2V _{pp} , f=120Hz		40		dB
ΔV _{OUT3} /ΔI _{OUT}	Load Regulation	Input code=255 in decimal 1mA≤I _{OUT3} ≤20mA			40	mV
ΔV _{OUT3} /ΔV _{IN}	Line Regulation	Input code=255 in decimal, R _{OUT3F} +0.2V≤V _{DD} ≤6.0V		0.2	0.4	%/V
ΔV _{OUT3} /ΔT _{opt}	Output Voltage Temperature Coefficient	-40°C≤T _{opt} ≤85°C		±100		ppm/°C

Unless otherwise provided, V_{DD}=3.6V I_{OUT3}=10mA.

Voltage Regulator4/ VR4: 20mA programmable output via serial interface / R5310L001B

Topt=25°C

Symbol	Item	Conditions	MIN.	TYP.	MAX.	Unit
V _{ROUT4Z}	Output Voltage with Zero Input	with Input code of decimal zero	0.94	1.00	1.06	V
V _{ROUT4F}	Output Voltage with Full Input	with Input code of decimal 255	2.9	3.0	3.1	V
DNL4	Differential Non-linearity	Input code=0 to 255 in decimal	-1		+1	LSB
INL4	Integral Non-linearity	Input code=0 to 255 in decimal	-2		+2	LSB
RES4	Output Voltage Resolution			8		bit
V _{DIF4}	Dropout Voltage	I _{OUT4} =20mA, Input code=255 in decimal		150	200	mV
I _{SS4}	Supply Current			250	400	μA
I _{lim4}	Current Limit	V _{ROUT4} =0V		20		mA
RR4	Ripple Rejection4	V _{DD} with sinusoidal 0.2Vpp, f=120Hz		40		dB
ΔV _{OUT4} /ΔI _{OUT}	Load Regulation	Input code=255 in decimal 1mA≤I _{OUT4} ≤20mA			40	mV
ΔV _{OUT4} /ΔV _{IN}	Line Regulation	Input code=255 in decimal, R _{OUT4F} +0.2V≤V _{DD} ≤6.0V		0.2	0.4	%/V
ΔV _{OUT4} /ΔTopt	Output Voltage Temperature Coefficient	-40°C≤Topt≤85°C		±100		ppm/°C

Unless otherwise provided, V_{DD}=3.6V I_{OUT4}=10mA.

Voltage Regulator5/ VR5: 50mA output for Analog / R5310L001B

Topt=25°C

Symbol	Item	Conditions	MIN.	TYP.	MAX.	Unit
V _{ROUT5}	Output Voltage		2.94	3.00	3.06	V
V _{DIF5}	Dropout Voltage	I _{OUT5} =50mA		150	200	mV
I _{SS5}	Supply Current			40	80	μA
I _{lim5}	Current Limit	V _{ROUT5} =0V		25		mA
RR5	Ripple Rejection5	V _{DD} with sinusoidal 0.2Vpp, f=1kHz		65		dB
ΔV _{OUT5} /ΔI _{OUT}	Load Regulation	1mA≤I _{OUT5} ≤50mA			40	mV
ΔV _{OUT5} /ΔV _{IN}	Line Regulation	R _{OUT5} +0.2V≤V _{DD} ≤6.0V		0.05	0.2	%/V
ΔV _{OUT5} /ΔTopt	Output Voltage Temperature Coefficient	-40°C≤Topt≤85°C		±100		ppm/°C

Unless otherwise provided, V_{DD}=3.6V I_{OUT5}=25mA.

Voltage Regulator6/ VR6: 300mA output for Base Band with External PNP Transistor / R5310L001B

Topt=25°C

Symbol	Item	Conditions	MIN.	TYP.	MAX.	Unit
V _{ROUT6}	Output Voltage	I _{OUT6} =150mA	2.94	3.00	3.06	V
V _{DIF6}	Dropout Voltage	I _{OUT6} =300mA		150	200	mV
I _{lim6}	Current Limit	V _{ROUT6} =0V	3	7	20	mA
RR6	Ripple Rejection6	V _{DD} with sinusoidal 0.2Vpp, f=1kHz		60		dB
ΔV _{OUT6} /ΔI _{OUT}	Load Regulation	1mA≤I _{OUT6} ≤300mA			40	mV
ΔV _{OUT6} /ΔV _{IN}	Line Regulation	I _{OUT6} =150mA, R _{OUT6} +0.2V≤V _{DD} ≤6.0V		0.05	0.2	%/V
ΔV _{OUT6} /ΔTopt	Output Voltage Temperature Coefficient	-40°C≤Topt≤85°C		±100		ppm/°C

Unless otherwise provided, V_{DD}=3.6V I_{OUT6}=300mA.

Voltage Regulator7/ VR7: 60mA output for Base Band / R5310L001B

Topt=25°C

Symbol	Item	Conditions	MIN.	TYP.	MAX.	Unit
V _{ROUT7}	Output Voltage		2.45	2.50	2.55	V
V _{DIF7}	Dropout Voltage	I _{OUT7} =60mA		200*1		mV
I _{SS7}	Supply Current			40	80	μA
I _{lim7}	Current Limit	V _{ROUT7} =0V		30		mA
RR7	Ripple Rejection5	V _{DD} with sinusoidal 0.2Vpp, f=1kHz		65		dB
ΔV _{OUT7} /ΔI _{OUT}	Load Regulation	1mA≤I _{OUT7} ≤60mA			40	mV
ΔV _{OUT7} /ΔV _{IN}	Line Regulation	3.2V≤V _{DD} ≤6.0V		0.05	0.2	%/V
ΔV _{OUT7} /ΔTopt	Output Voltage Temperature Coefficient	-40°C≤Topt≤85°C		±100		ppm/°C

Unless otherwise provided, V_{DD}=3.6V I_{OUT7}=30mA.*1: V_{DD} cannot be set at equal or less than V_{DET2}, therefore, actual measurement is impossible, this value is only guaranteed by design.

Voltage Regulator8/ VR8: 150mA output for Vibrator / R5310L001B

Topt=25°C

Symbol	Item	Conditions	MIN.	TYP.	MAX.	Unit
V _{ROUT8}	Output Voltage		1.247	1.300	1.353	V
V _{DIF8}	Dropout Voltage	I _{OUT8} =150mA		1300*2		mV
I _{SS8}	Supply Current			5	15	μA
I _{lim8}	Current Limit	V _{ROUT8} =0V		75		mA
RR8	Ripple Rejection5	V _{DD} with sinusoidal 0.2Vpp, f=120Hz		40		dB
ΔV _{OUT8} /ΔI _{OUT}	Load Regulation	1mA≤I _{OUT8} ≤150mA			40	mV
ΔV _{OUT8} /ΔV _{IN}	Line Regulation	3.2V≤V _{DD} ≤6.0V		0.05	0.2	%/V
ΔV _{OUT8} /ΔTopt	Output Voltage Temperature Coefficient	-40°C≤Topt≤85°C		±100		ppm/°C

Unless otherwise provided, V_{DD}=3.6V I_{OUT8}=75mA.*2: V_{DD} cannot be set at equal or less than V_{DET2}, therefore, actual measurement is impossible, this value is only guaranteed by design.

Voltage Detector1/ VD1: for CPU Reset with external capacitor / R5310L001B

Topt=25°C

Symbol	Item	Conditions	MIN.	TYP.	MAX.	Unit
V _{DET1}	Detect Voltage		2.646	2.700	2.754	V
V _{HYS1}	Hysteresis Range		V _{DET1} × 1.5%	V _{DET1} × 3%	V _{DET1} × 5%	V
V _{DIR6}	Margin to Released Voltage	R _{OUT6} -V _{DET1} Released Voltage	50	219		mV
T _{VDET1}	Output Delay time	C _D =0.15μF	50	100	200	ms
ΔV _{DET1} /ΔTopt	Detector Threshold Temperature Coefficient	Topt=-40°C to +85°C		±100		ppm/°C

Voltage Detector2/ VD2: for Battery Low Voltage Detection / R5310L001B

Topt=25°C

Symbol	Item	Conditions	MIN.	TYP.	MAX.	Unit
V _{DET2}	Detect Voltage		2.94	3.00	3.06	V
V _{HYS2}	Hysteresis Range		V _{DET2} × 1.5%	V _{DET2} × 3%	V _{DET2} × 5%	V
ΔV _{DET2} /ΔTopt	Detector Threshold Temperature Coefficient	Topt=-40°C to +85°C		±100		ppm/°C

Voltage Detector3/ VD3: for Excess input Voltage Detection / R5310L001B

Topt=25°C

Symbol	Item	Conditions	MIN.	TYP.	MAX.	Unit
V _{DET3}	Reset Voltage		6.048	6.300	6.552	V
ΔV _{DET3} /ΔTopt	Detector Threshold Temperature Coefficient	Topt=-40°C to +85°C		±100		ppm/°C

Voltage Detector4/ VD4: for Backup battery protection / R5310L001B

Topt=25°C

Symbol	Item	Conditions	MIN.	TYP.	MAX.	Unit
V _{DET4}	Reset Voltage		3.212	3.450	3.688	V
ΔV _{DET4} /ΔTopt	Detector Threshold Temperature Coefficient	Topt=-40°C to +85°C		±100		ppm/°C

Output port 1/ 10mA: for LED Driver1 / R5310L001B

Topt=25°C

Symbol	Item	Conditions	MIN.	TYP.	MAX.	Unit
V _{POH1A}	“H” Output Voltage	I _{OH1} =-10mA, V _{VP} =V _{ROUT6} , V _{DD} =R _{OUT6} +0.2V to 6V	V _{VP} -0.5			V
V _{POH1B}	“H” Output Voltage	I _{OH} =-10mA, V _{VP} =V _{DD} =R _{OUT6} +0.2V to 6V	V _{VP} -0.4			V
V _{POL1}	“L” Output Voltage	I _{OL} =1mA, V _{VP} =R _{OUT6} or V _{DD} , V _{DD} =R _{OUT6} +0.2V to 6V			0.4	V

Unless otherwise provided, R_{SET6}=3.0V

Output port 2/ 40mA: for LED Driver2 / R5310L001B

Topt=25°C

Symbol	Item	Conditions	MIN.	TYP.	MAX.	Unit
V _{POH2A}	“H” Output Voltage	I _{OH1} =-40mA, V _{VP} =V _{ROUT6} , V _{DD} =R _{OUT6} +0.2V to 6V	V _{VP} -0.5			V
V _{POH2B}	“H” Output Voltage	I _{OH} =-40mA, V _{VP} =V _{DD} =R _{OUT6} +0.2V to 6V	V _{VP} -0.4			V
V _{POL2}	“L” Output Voltage	I _{OL} =1mA, V _{VP} =R _{OUT6} or V _{DD} , V _{DD} =R _{OUT6} +0.2V to 6V			0.4	V

Unless otherwise provided, R_{SET6}=3.0V

Output port 3/ 100mA: for LED Driver3 / R5310L001B

Topt=25°C

Symbol	Item	Conditions	MIN.	TYP.	MAX.	Unit
V _{POH2A}	“H” Output Voltage	I _{OH1} =-100mA, V _{VP} =V _{ROUT6} , V _{DD} =R _{OUT6} +0.2V to 6V	V _{VP} -0.5			V
V _{POH2B}	“H” Output Voltage	I _{OH} =100mA, V _{VP} =V _{DD} =R _{OUT6} +0.2V to 6V	V _{VP} -0.4			V
V _{POL2}	“L” Output Voltage	I _{OL} =1mA, V _{VP} =R _{OUT6} or V _{DD} , V _{DD} =R _{OUT6} +0.2V to 6V			0.4	V

Unless otherwise provided, R_{SET6}=3.0V

Ringer Controller / R5310L001B

T_{opt}=25°C

Symbol	Item	Conditions	MIN.	TYP.	MAX.	Unit
F _{IG}	TONE Pulse Frequency	R _{LG} =16Ω	DC		10	kHz
R _{LG}	Resistive Load	Nominal number	6		32	Ω
C _{LG}	Capacitive Load	R _{LG} =16Ω			1000	pF
V _{G7}	Output Voltage for G _{SEN1} pin with input code of seven	Ringer switch bit='1', Input code to the EV is seven in decimal. R _{LG} =16Ω	V _{ROUT5-} 0.1	V _{ROUT5}	V _{ROUT5+} 0.1	V
V _{G0}	Output Voltage for G _{SEN1} pin with input code of zero	Ringer switch bit='1', Input code to the EV is zero in decimal. R _{LG} =16Ω	TYP- 2dB	V _{ROUT5-} 21dB	TYP+ 1.5dB	V
V _{G_{OFF}}	Output Voltage for G _{SEN1} pin with Ringer switch bit of zero	Ringer switch bit='0' R _{LG} =16Ω		0	0.05	V
RES _{GEV}	Electronic Volume Resolution			3		bit
V _{GEV27}	Electronic Volume Step	R _{LG} =16Ω, Each step of input code from 2 to 7	2.5	3	3.5	dB
V _{GEV12}	Electronic Volume Step	R _{LG} =16Ω, Each step of input code from 1 to 2	2.4	3	3.6	dB
V _{GEV01}	Electronic Volume Step	R _{LG} =16Ω, Each step of input code from 0 to 1	2.2	3	3.8	dB
I _{SCR}	Current Limit	G _{SEN} =0V	2.5	5	10	mA
I _{SSG}	Supply Current	R _{LG} =16Ω		600	900	μA

R_{SET5}=3.0V

Battery Monitor: Analog output / R5310L001B

T_{opt}=25°C

Symbol	Item	Conditions	MIN.	TYP.	MAX.	Unit
V _{BOUT1A}	Output Voltage	I _{OUT} =0μA, B _{MON1} =3.2 to 6V, V _{DD} =6V	0.66× B _{MON1} - 2%	0.66× B _{MON1}	0.66× B _{MON1} + 2%	V
V _{BOUT1B}	Output Voltage	I _{OUT} =0μA, B _{MON1} =V _{DD} =3.2 to 6V	0.66× B _{MON1} - 2%	0.66× B _{MON1}	0.66× B _{MON1} + 2%	V
R _{BO1}	Output Impedance			2.7k	5k	Ω
I _{SSBO1}	Supply Current	Battery Monitor switch bit='1'		300	500	μA
ΔV _{BOUT1} / ΔT _{opt}	Output Voltage Temperature Coefficient			±100		ppm/°C

Digital Input / Output Conditions / R5310L001B

T_{opt}=25°C

Symbol	Item	Pins	MIN.	TYP.	MAX.	Unit
V _{IH1}	“H” Input Voltage	CSW1, 2, 4, TONE	0.8× V _{ROUT6}		V _{DD+} 0.3	V
V _{IH2}	“H” Input Voltage	CSB, SCK, DATA* ¹	0.8× V _{ROUT6}		V _{ROUT6}	V
V _{IL}	“L” Input Voltage	CSB, SCK, DATA, CSW1, 2, 4, TONE	-0.3		0.2× V _{ROUT6}	V
V _{HYS}	Hysteresis range	CSB, SCK, DATA, CSW1, 2, 4, TONE		0.25× V _{ROUT6}		V
V _{OH1}	“H” Output Voltage	DOUT1, DOUT2, I _{OH} =0mA	V _{ROUT6} - 0.4			V
V _{OH2}	“H” Output Voltage	DOUT1, DOUT2, I _{OH} =-0.2mA	V _{ROUT6} - 0.4			V
V _{OL}	“L” Output Voltage	DOUT1, DOUT2, I _{OL} =1mA			0.4	V
R _{PU}	Pull-up Resistance	CSB, SCK, DATA	0.12	0.3	0.8	MΩ
R _{PD}	Pull-down Resistance	CSW1, 2, 4, TONE	0.12	0.3	0.8	MΩ

*1: The pins specified as above are pulled up to the R_{OUT6} pin through resistors internally.

Therefore the higher input voltage than V_{ROUT6} cause a rising of V_{ROUT6} incorrectly, particularly with small load current.

AC CHARACTERISTICS / R5310L001B

V_{DD}=3.6V, V_{SS}=0V, C_L=20pF, T_{opt}=25°C

Symbol	Item	MIN.	TYP.	MAX.	Unit
t _{CEH}	SCK to CSB “H” hold time	100			ns
t _{CES}	CSB to SCK setup time	200			ns
t _{CEL}	SCK to CSB “L” hold time	100			ns
t _{SCK}	SCK cycle	500			ns
t _{CKL}	SCK “L” time	250			ns
t _{CKH}	SCK “H” time	250			ns
t _{DS}	DATA to SCK setup time	100			ns
t _{DH}	SCK to DATA hold time	100			ns

Timing Diagram

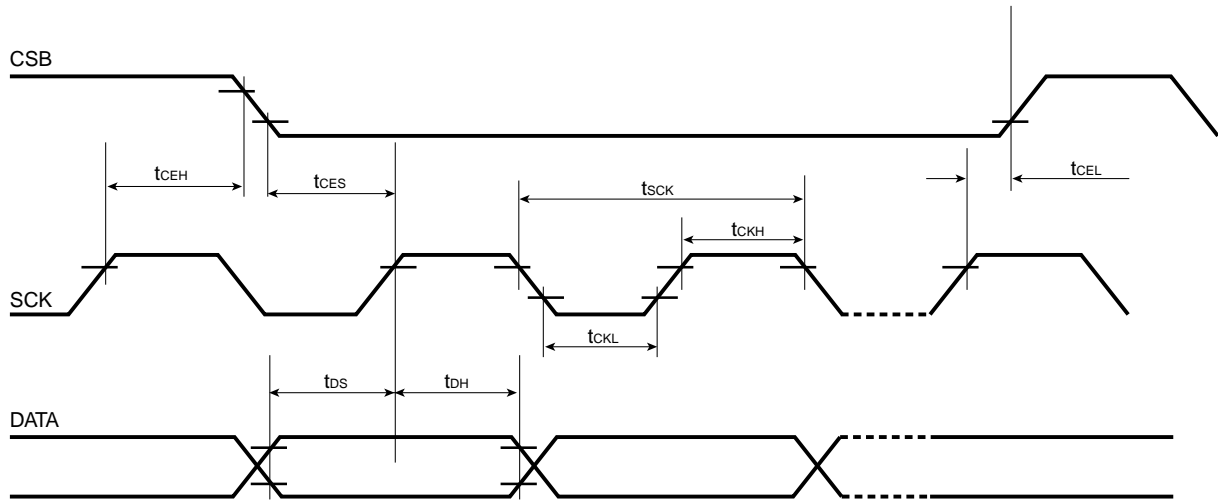

$$V_{IH}=0.8 \times V_{ROUT6}$$

$$V_{IL}=0.2 \times V_{ROUT6}$$

FUNCTIONAL DESCRIPTION

1. 3-wire Serial Interface

1-1. Data Transfer Summary

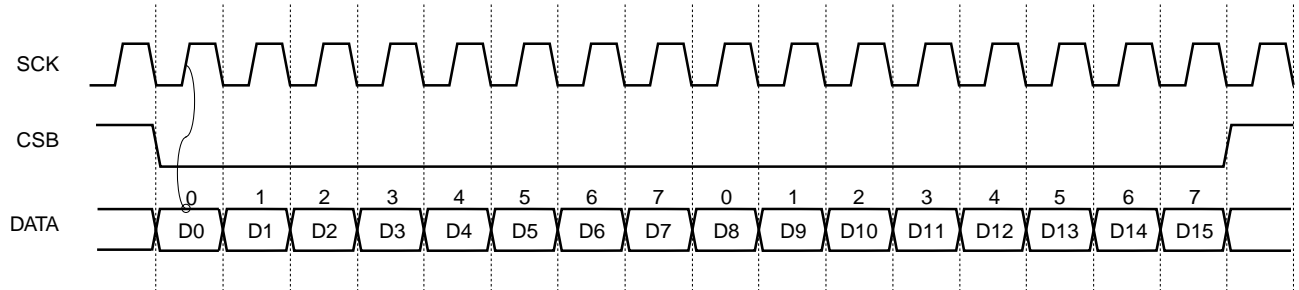

All data transfers are initiated by driving the CSB input low. The CSB input serves two functions. First, CSB turns on the control logic which allows access to the shift register for the address/command sequence. Second, the CSB signal provides a method of terminating data transfer. A clock cycle is a sequence of a falling edge followed by a rising edge. For data inputs, data must be valid during the rising edge of the clock.

All data transfer terminates if the CSB input is high. Data transfer is illustrated as above.

1-2. Command Byte

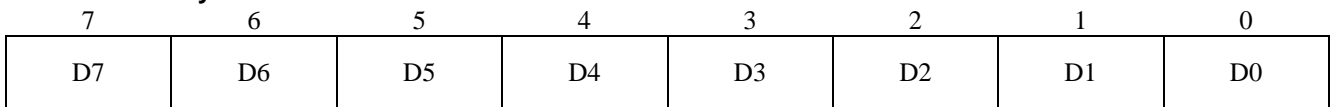

The Command byte is shown as above. Each data transfer is initiated by a command byte.

The LSB (bit zero) must be a logic zero. An any data for each of bit six and bit seven which might be zero or one, is ignored. Bits one through five specify the designated registers to be input.

The command byte is always input starting with the LSB (bit zero).

1-3. Data Input

Following the eight SCK cycles that input a write command byte, a data byte is input on the rising edge of the next eight SCK cycles. And any successive instruction set which consists of command byte and data byte is allowable. The data byte is always input starting with the LSB (bit zero).

1-4. Regulator Switch

Each of regulators can be enabled or disabled independently. In the VR switch register, designations for each of seven regulators' ON/OFF can be written to bit zero through six. Bit seven is ignored.

1-5. Battery Monitor / LED Drivers / Ringer Controller

An analog output of cell voltage monitor is available with enable switch. Three of constant voltage outputs for LEDs and a ringer controller can be independently ON/OFF. All of those enable switches are controlled by output port register. Bit zero and one through three are for enable switch of battery monitor and LED drivers respectively.

Bit four through six is input digit of electronic volume for ringer controller, bit four is defined as the LSB. Bit seven is enable switch for ringer controller.

1-6. Programmable Voltage Regulators /VR3, 4

The output voltage of VR3 and VR4 can be controlled externally by written data to the VR3/VR4 output registers.

VR3 outputs from 0.5V to 2.492V, VR4 outputs from 1.008V to 3.0V with eight bit resolution for each. Bit zero of each register is the LSB.

1-7. Register Address / Register Definition

VR switch Register Address

D7	D6	D5	D4	D3	D2	D1	D0
-	-	0	0	0	1	0	-

VR switch Register Definition

D15	D14	D13	D12	D11	D10	D9	D8
-	VR8	VR7	VR5	VR4	VR3	VR2	VR1
-	1:VR7=ON 0:VR7=OFF	1:VR6=ON 0:VR6=OFF	1:VR5=ON 0:VR5=OFF	1:VR4=ON 0:VR4=OFF	1:VR3=ON 0:VR3=OFF	1:VR2=ON 0:VR2=OFF	1:VR1=ON 0:VR1=OFF

Output port Register Address

D7	D6	D5	D4	D3	D2	D1	D0
-	-	1	0	0	1	0	-

Output port Register Definition

D15	D14	D13	D12	D11	D10	D9	D8
RNG	EV2	EV1	EV0	O3	O2	O1	VMB
1: Ringer controller ON 0: Ringer controller OFF	EV0 through EV2 defines input digit of 3 bit electronic volume for ringer. EV0 (D4) is the LSB			1: LED driver3 ON 0: LED driver3 OFF	1: LED driver2 ON 0: LED driver2 OFF	1: LED driver1 ON 0: LED driver1 OFF	1: Battery monitor ON 0: Battery monitor OFF

VR3 Output Register Address

D7	D6	D5	D4	D3	D2	D1	D0
-	-	0	1	0	1	0	-

VR3 Output Register Definition

D15	D14	D13	D12	D11	D10	D9	D8
DA37	DA36	DA35	DA34	DA33	DA32	DA31	DA30
DA30 through DA37 defines input codes of DAC for VR3. Data must be input starting with DA30 (LSB)							

VR4 Output Register Address

D7	D6	D5	D4	D3	D2	D1	D0
-	-	1	1	0	1	0	-

VR4 Output Register Definition

D15	D14	D13	D12	D11	D10	D9	D8
DA47	DA46	DA45	DA44	DA43	DA42	DA41	DA40
DA40 through DA47 defines input codes of DAC for VR4. Data must be input starting with DA40 (LSB)							

*Note: Initial condition of DAC code for VR3 and 4 is "FF". (full code)

1-8. Operation after Interrupt Procedure

In the case that CSB input becomes to high by interrupting while a command-set which has not yet been acknowledged, the command-set is disabled by internal reset signal, therefore, after this case, transaction should be executed from the initial condition.

2. Voltage Regulators

Embedded 8 regulators are classified into 4 groups as follows by their characteristics:

[High Speed Type] VR1, 2, 5, 7

With High ripple rejection (Typ. 65dB at 1kHz) and Low Noise, they are suitable for RF and analog circuits.

And the load transient response is also good, therefore they are recommendable for DSP which requires fast dynamic response to load current.

[Adjustable Output Voltage Type] VR3, 4

They include 8-bit D/A converter (guaranteed monotonous increase) each, users can select output voltage in a range by 3-wire serial interface control. They are suitable for various applications which do not require much load current (Max. 20mA), such as PA bias, AGC, LCD luminance adjuster and can be used as voltage references.

[Boost Type] VR6

VR6 is used with an external PNP transistor and can supply large output current. This regulator is always ON, therefore its supply current is enough minimized to save invalid current by design (Typ. 6μA).

[For Vibrator] VR8

VR8 can drive a vibrator (which requires 1.3V as a supply voltage) directly.

3. Voltage Detectors

VD1 monitors the voltage of VR6, when the voltage becomes lower than setting detector threshold voltage, D_{OUT1} pin becomes “L”, and internal logic is initialized, furthermore does not accept input signal. It is suitable for reset CPU. Output type is Nch open drain and pull-up resistance to VR6. Setting output delay time (Reset Released Delay Time) is possible with connecting an external capacitance to C_D pin. The formula which shows the relation between External capacitance value (C_D) and output delay time is as follows:

$$tD=0.67 \times 10^6 \times C_D$$

VD2 monitors V_{DD} voltage, when the voltage becomes lower than setting output voltage threshold, D_{OUT2} becomes “L”, and disables VR6. It is suitable for detecting cutting off a battery voltage in a flash and can be used to set a operation starting voltage. Output Type is CMOS and its “H” level equals to voltage of R_{OUT6}.

VD3 monitors also V_{DD} voltage, when the voltage becomes higher than setting output threshold, VD3 disables VR6. It is necessary to protect circuits from large input voltage.

VD4 monitors the voltage of VR6, when the voltage becomes higher than setting output threshold, it disables VR6 and protect a coin battery for backup. When R_{OUT6} is equal or less than setting output threshold, VR6 turns on again. Thus, the operation is repeated until VR6 outputs normal voltage.

4. Ringer Controller

Ringer controller is composed with an external PNP transistor. It can control a Ringer in the range from 6Ω to 32Ω.

By 3-wire interface controller, ON and OFF, 3bit electrical volume can be controlled. The Output is also controlled to accept “ON” command and input signal of TONE pin via 3-wire interface, thus it can generate any melody. Output condition via 3-wire interface controller inputs and TONE input is shown below:

3-wire input	TONE input	Ringer Output	Supply Current (for Ringer Controller Circuit Part)
0 (OFF)	0 or 1	OFF	(almost 0μA)
1 (ON)	0	OFF (standby)	(approximately 500μA)
1 (ON)	1	ON	(approximately 100μA (only for internal circuit))

5. LED Drivers

3 LED drivers are embedded and each of them can control independently, and ON/OFF condition can be controlled via 3-wire interface. P_{OUT1} is applicable for display of receiving a call. Output is controlled with “ON” command or input signal for TIMER pin via 3-wire interface, lighting and flashing can be set freely. P_{OUT2} can be used to drive an LCD back-light, P_{OUT3} is for a back-light for keys.

P_{OUT2} and P_{OUT3} is controlled only via 3-wire interface. The Source for P_{OUT1} to 3 is V_p pin. Users can connect it to V_{DD} or R_{OUT6}. Output type is CMOS, thus they can be used as general output ports.

6. Voltage Monitor

Voltage monitor is composed with connecting a Pch MOS switch to an upper part of divider resistors. It can be “ON” and “OFF” via 3-wire interface.

When it is “ON” state, the voltage of monitor pin or B_{MON1} is divided with a specific ratio and output to B_{OUT1} pin.

When it is “OFF” state, B_{MON1} is on high impedance condition, thus B_{OUT1} is pulled down through a resistance (the value is approximately 8kΩ) to GND.

TECHNICAL NOTES

● Operation with rising and falling of Supply Voltage

1. Supply voltage condition --- from 0V to a designated voltage

To make the explanation be easier, we call a voltage which is monitored and rising voltage threshold, as “Released Voltage”. On the contrary, we call the falling voltage threshold as “Detector Threshold Voltage”. And the difference between them is specified as a Hysteresis Voltage.

While the supply voltage is from 0V to VD2 (Released Voltage), all the circuits except VDs are “OFF” state, thus both levels of D_{OUT1} and 2 are “L”. However, we cannot guarantee the operation with a V_{DD} at voltage below the minimum operating voltage (V_{DDMIN}) with both a rising and a falling conditions. When the supply voltage crosses over the Released Voltage for VD2, D_{OUT2} becomes “H” and VR6 is enabled.

Further, when R_{OUT6} crosses over the Released Voltage for VD1, after a setting delay time by an external capacitor to C_D pin, D_{OUT1} becomes “H”, then internal logic circuits and reset condition for input control pins (3-wire interface inputs and CSW_x etc.) are released. Therefore circuits' operations can become to control by these input pins.

2. Supply voltage condition --- from a designated voltage to 0V

When the supply voltage becomes lower than Detector Threshold Voltage for VD2, D_{OUT2} becomes “L” and disables VR6. Further, VR6 level becomes lower than Detector Threshold Voltage for VD1, then D_{OUT1} becomes “L” and reset internal logic circuits and input controller pins (3-wire inputs and CSW_x etc.)

Then all the circuits except VDs are OFF (See the Note below), and input signals for control are not accepted.

The lower voltage than this is as same as above.

<Note>

As for VR1, when supply voltage is equal or less than Detector Threshold Voltage for VD2, output is indefinite (ON/OFF). At this condition, both CSW1 pin input and 3-wire controller inputs cannot be accepted.

This operation could cause a problem on your system, and should be considered enough.

● Block Diagram of VDs

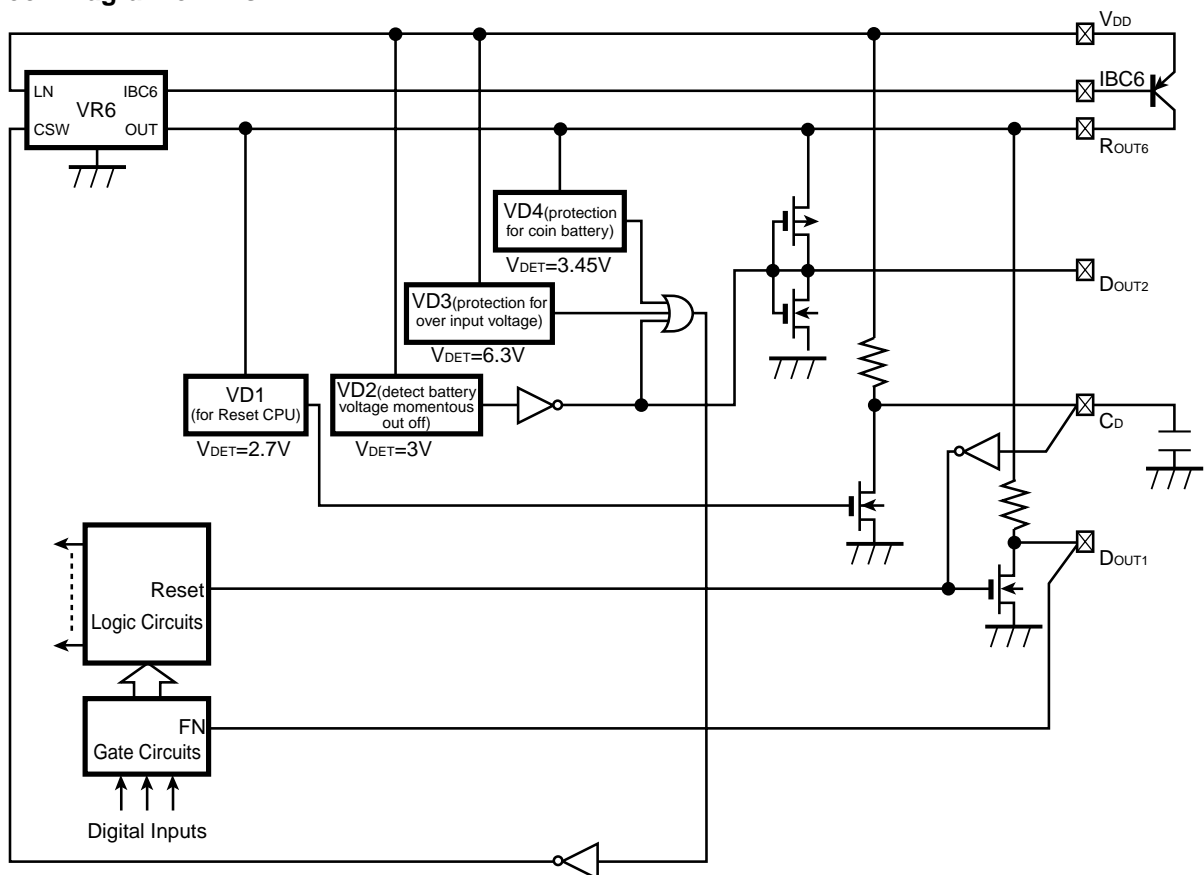

TEST CIRCUITS

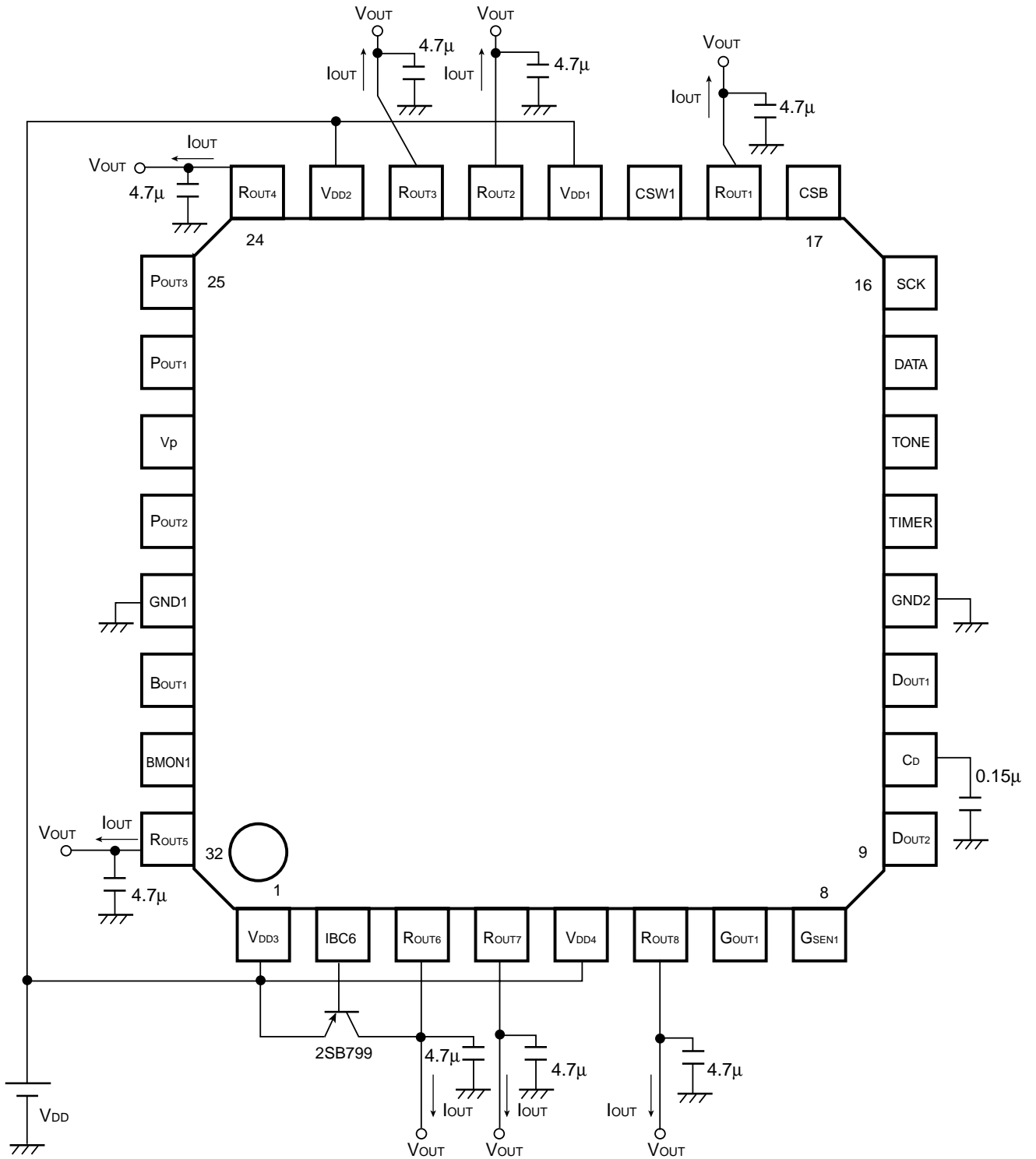

Figure-1: Standard Test Circuit

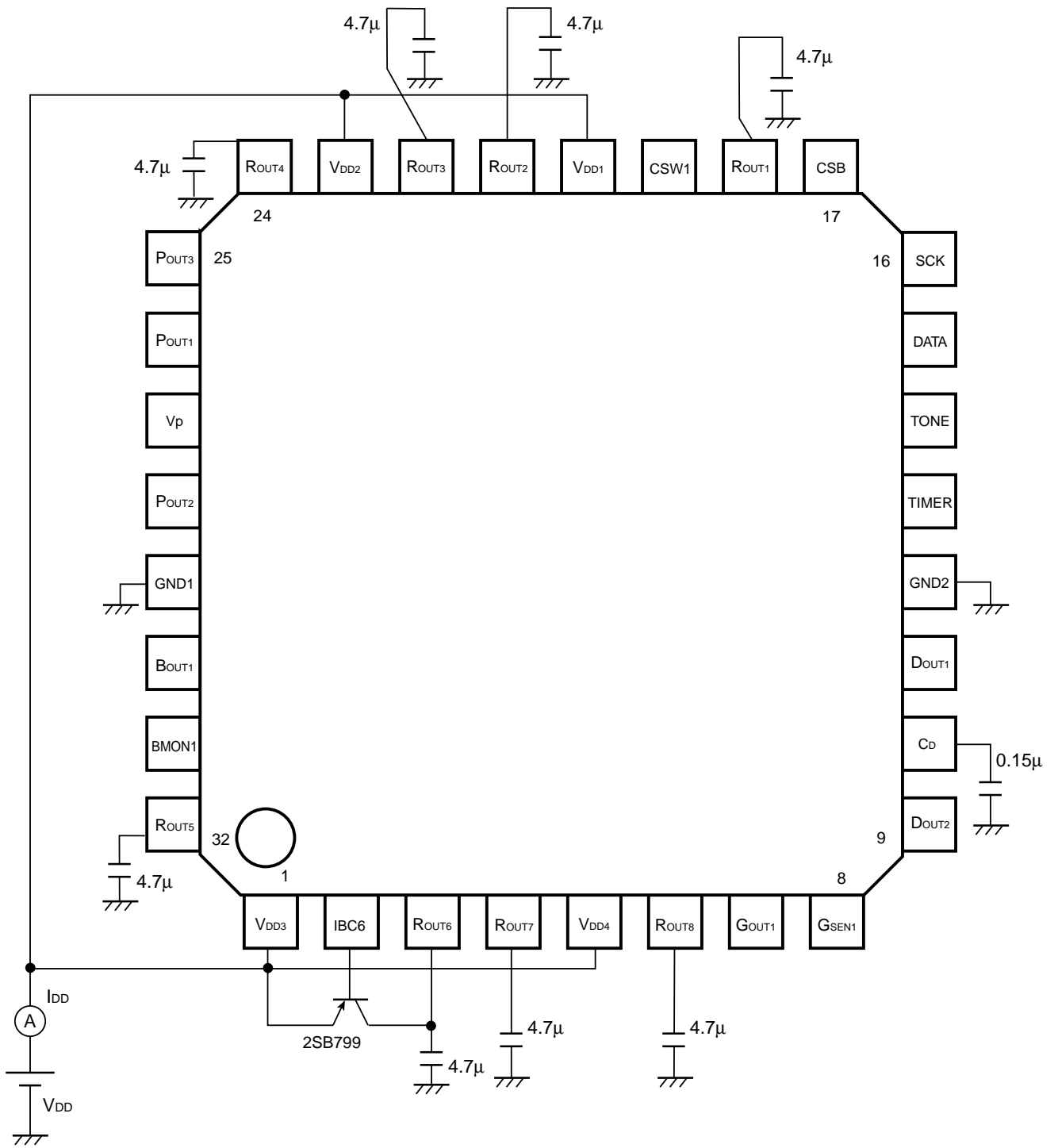

Figure-2: Test Circuit for Supply Current

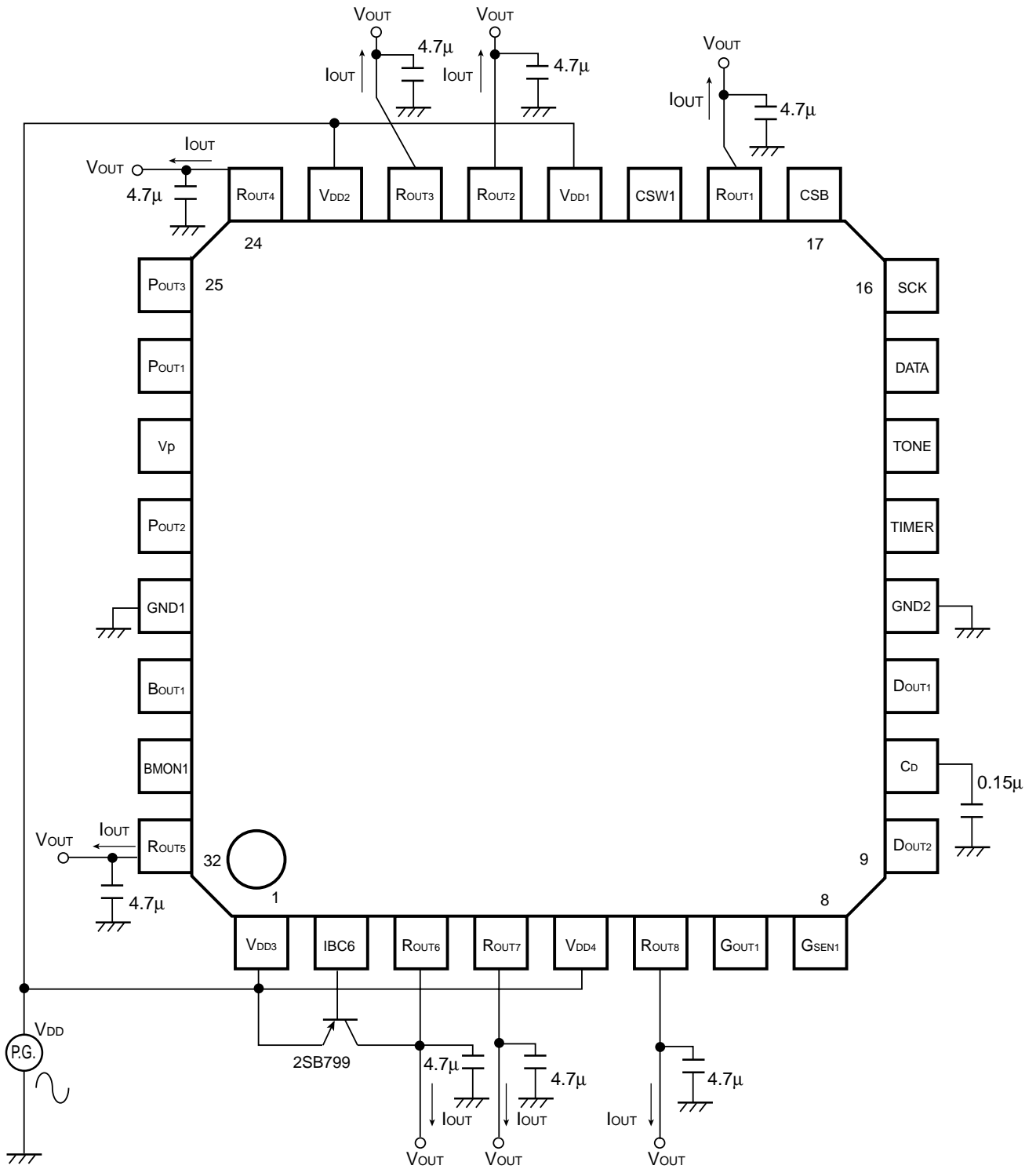

Figure-3: Test Circuit for Ripple Rejection

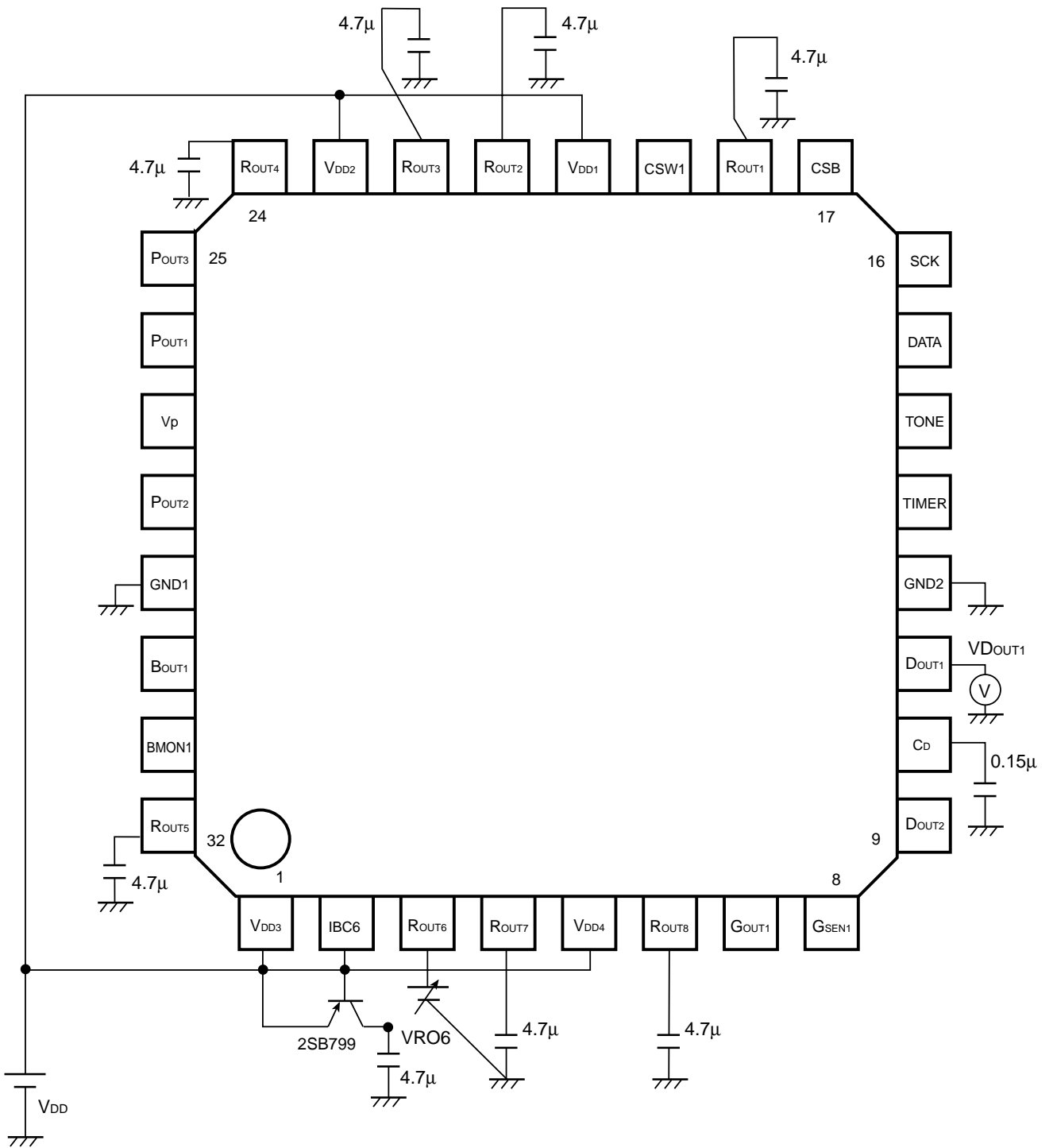

Figure-4: Test Circuit for Detector Threshold level of VD1

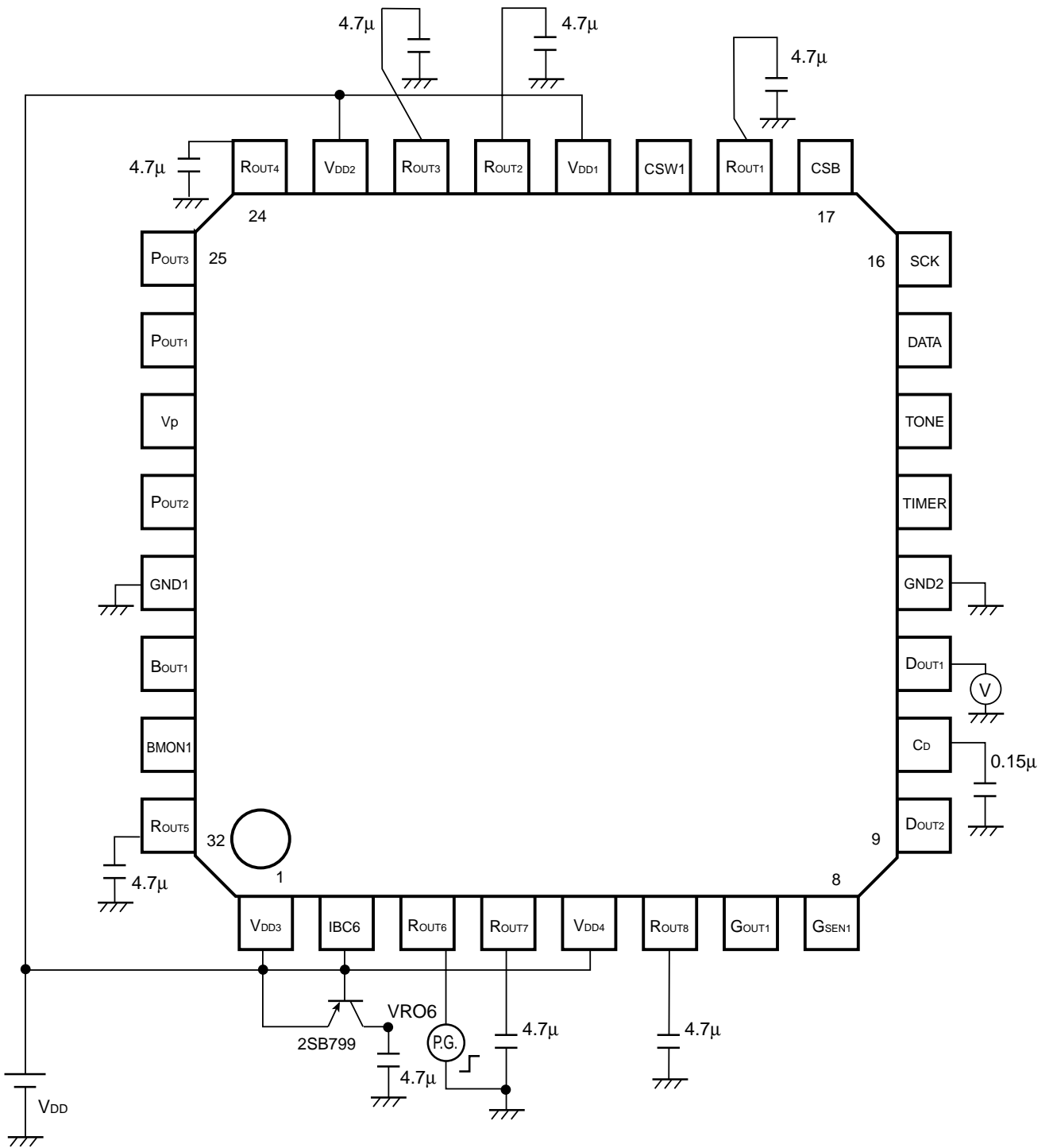

Figure-5: Test Circuit for Released Voltage level of VD1

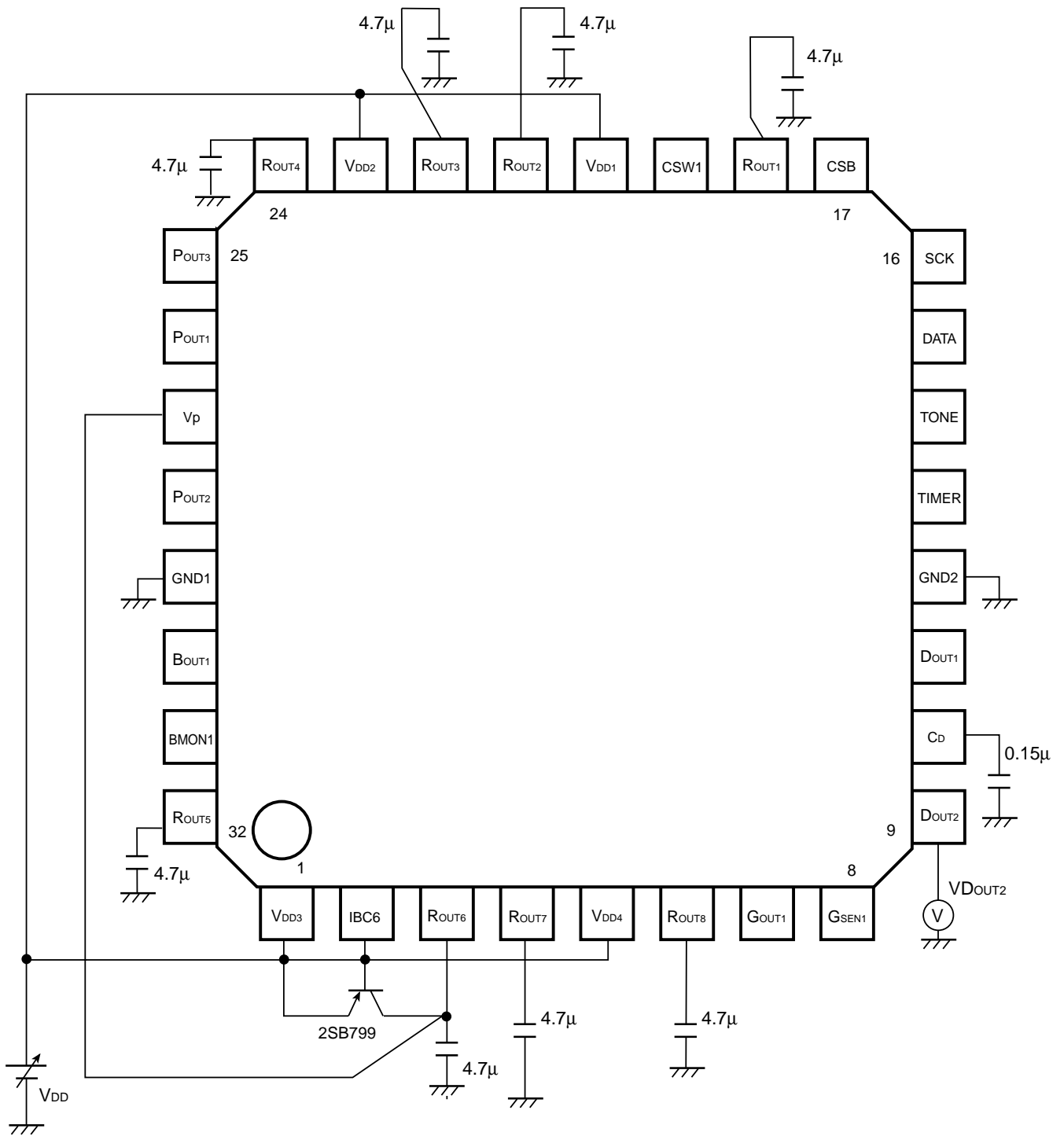

Figure-6: Test Circuit for Characteristics of VD2 and VD3

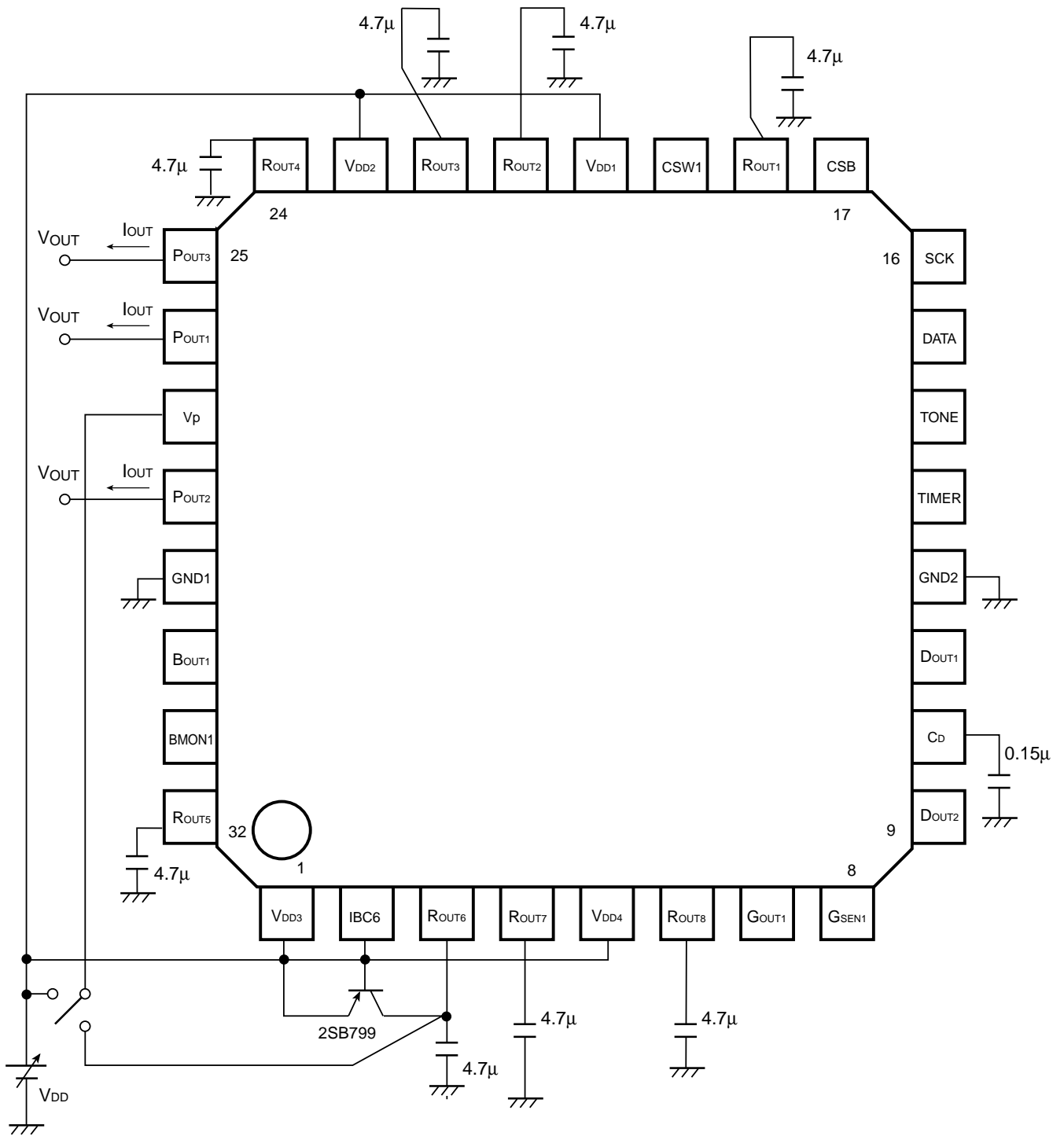

Figure-7: Test Circuit for Characteristics of LED Drivers

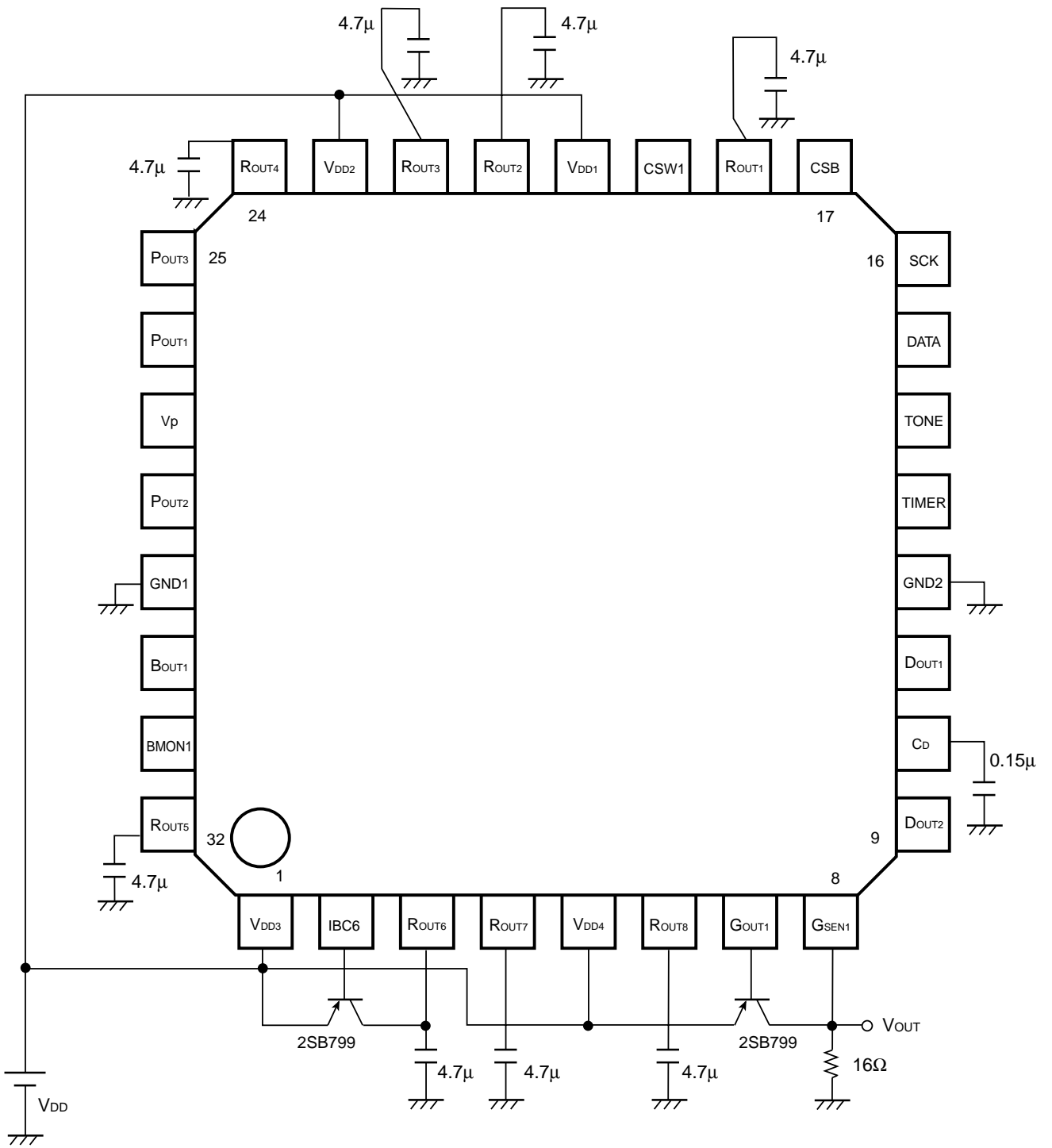

Figure-8: Test Circuit for Characteristics of Ringer Controller

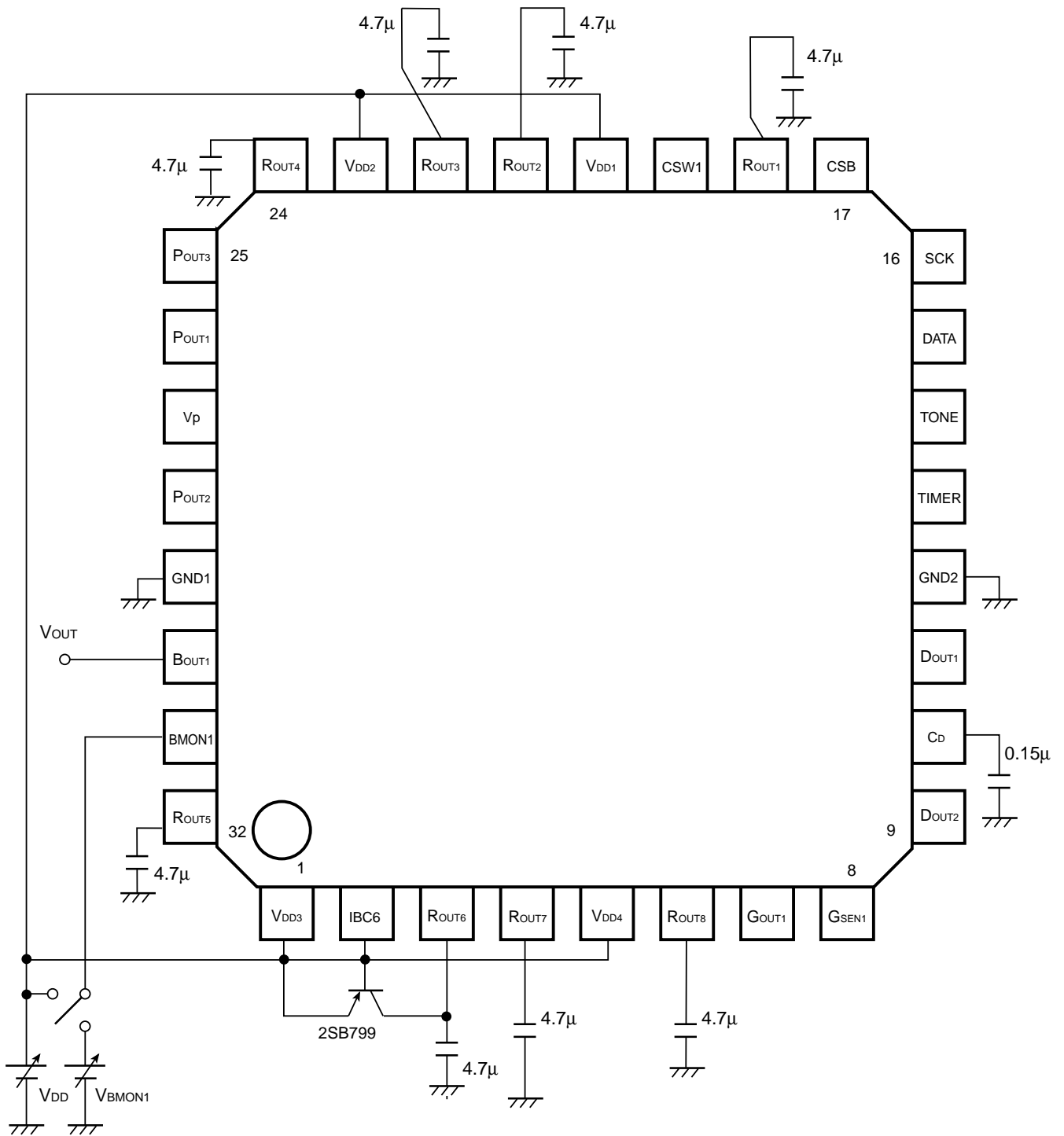

Figure-9: Test Circuit for Characteristics of Voltage Monitor

■ TYPICAL CHARACTERISTICS

1) Output Voltage vs. Temperature

Regulator1 (3V)

V_{DD}=3.6V I_{OUT}=60mA

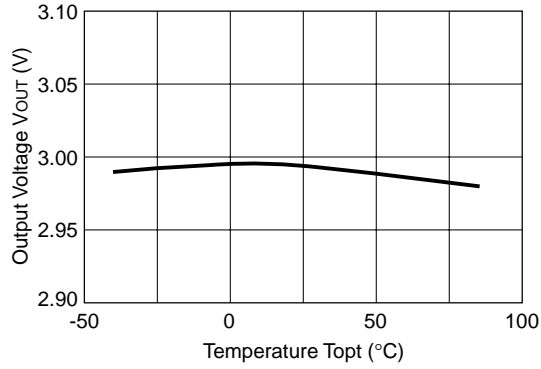

Regulator2 (3V)

V_{DD}=3.6V I_{OUT}=40mA

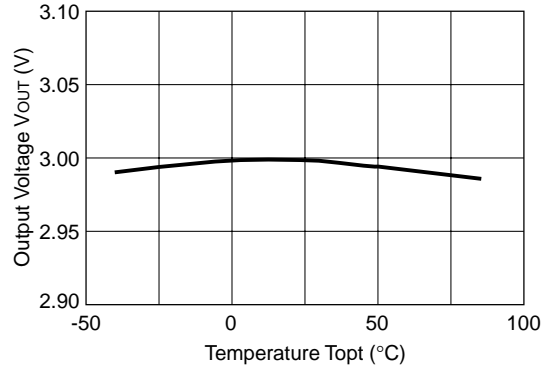

Regulator3 (3V)

V_{DD}=3.6V I_{OUT}=10mA

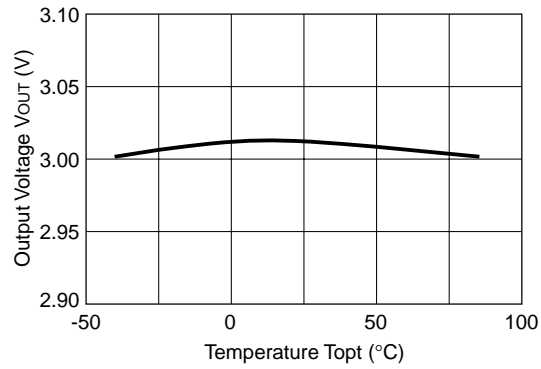

Regulator4 (3V)

V_{DD}=3.6V I_{OUT}=10mA

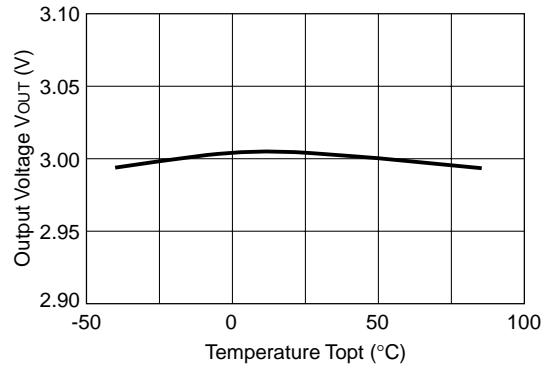

Regulator5 (3V)

V_{DD}=3.6V I_{OUT}=25mA

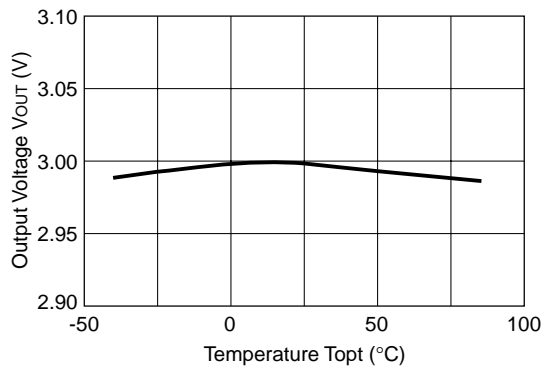

Regulator6 (3V)

V_{DD}=3.6V I_{OUT}=150mA

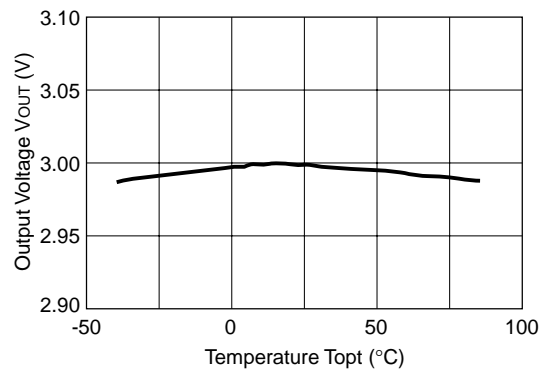

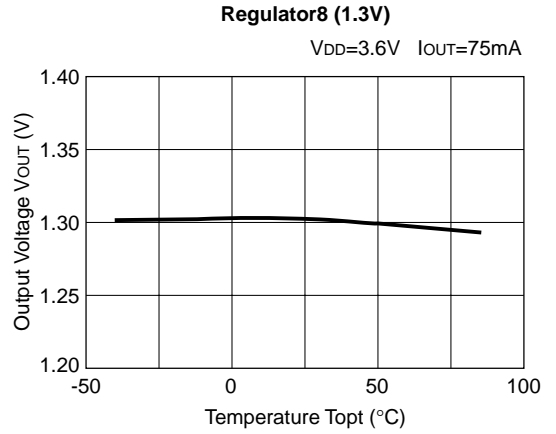
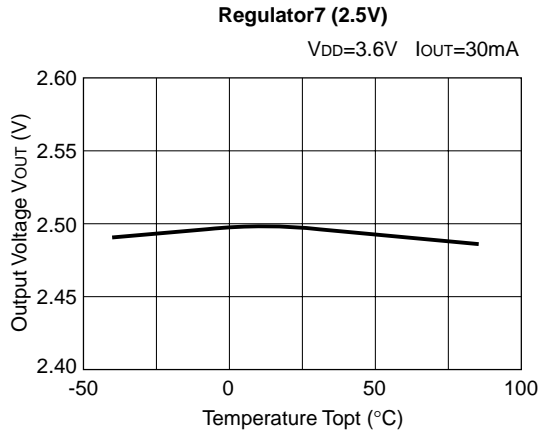

2) Supply Current vs. Temperature
Regulator1 (3V)

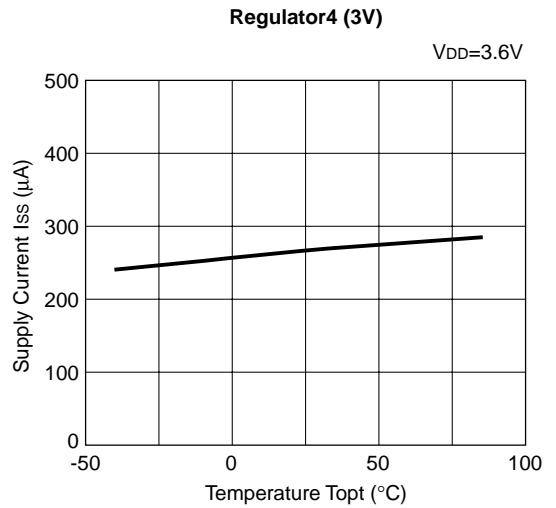
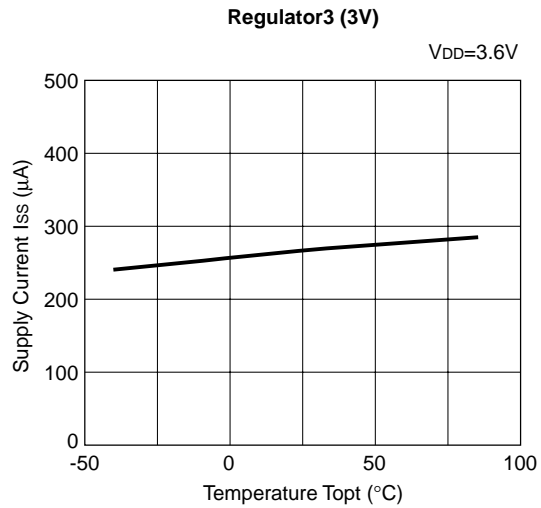
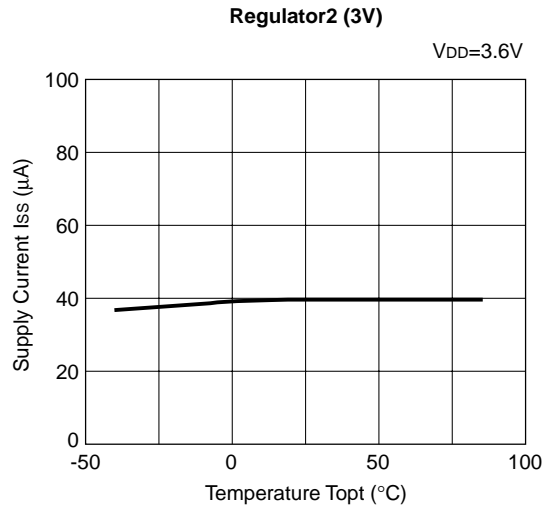
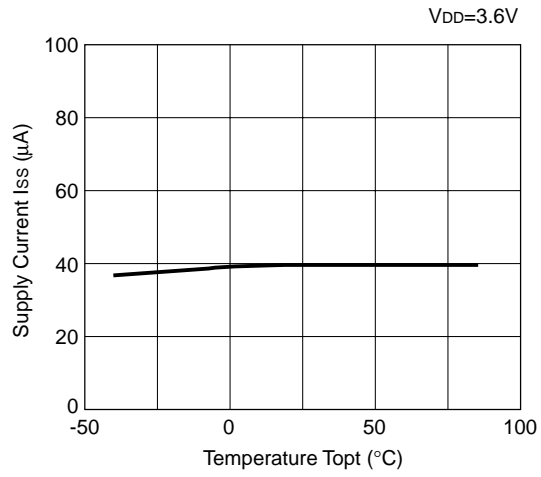

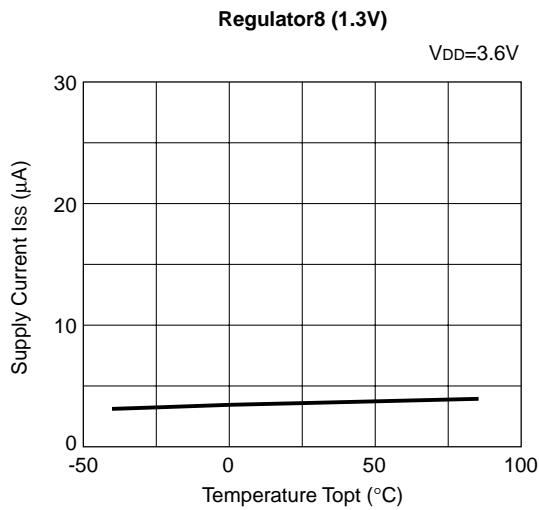
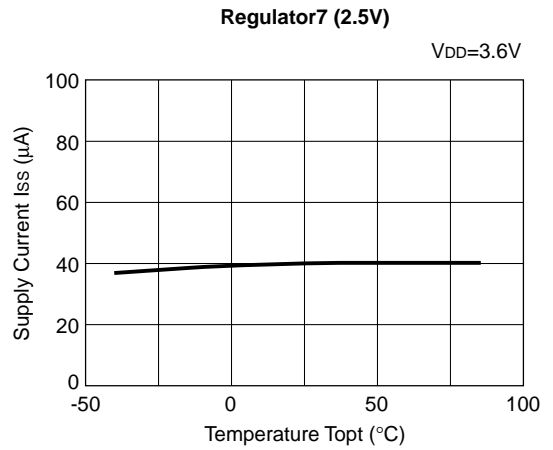
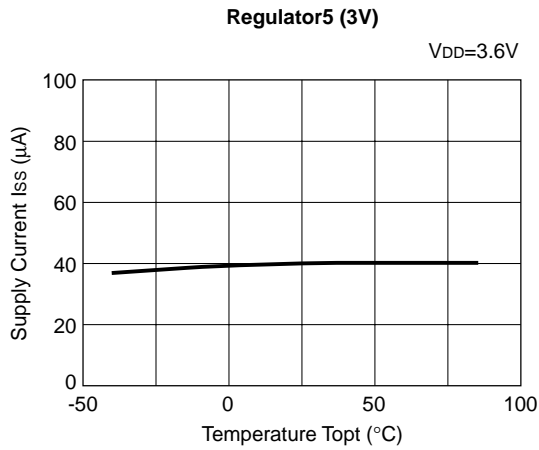

3) Dropout Voltage vs. Temperature

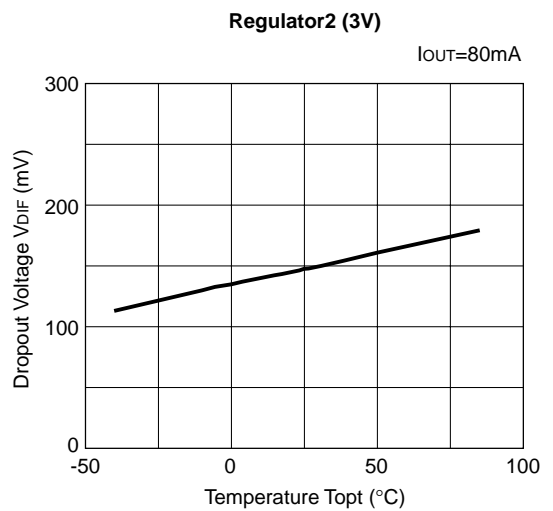
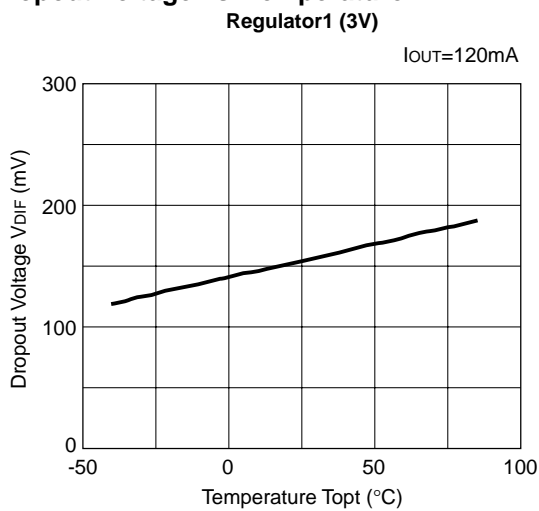

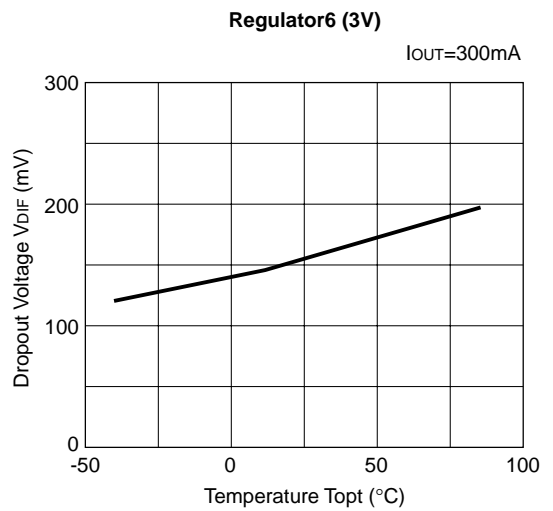
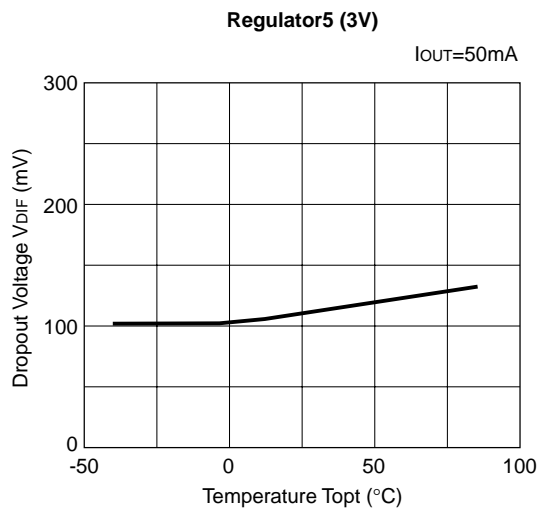
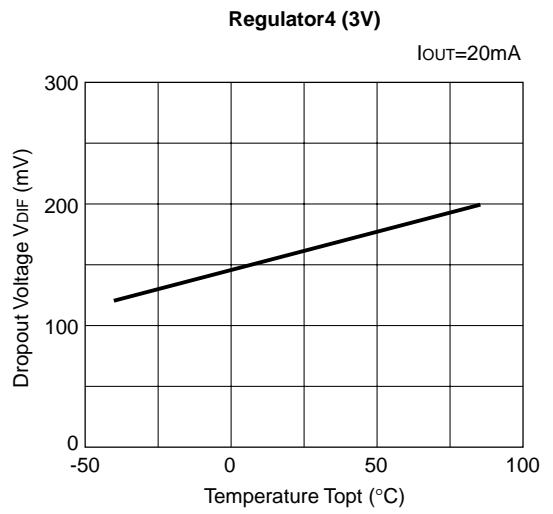
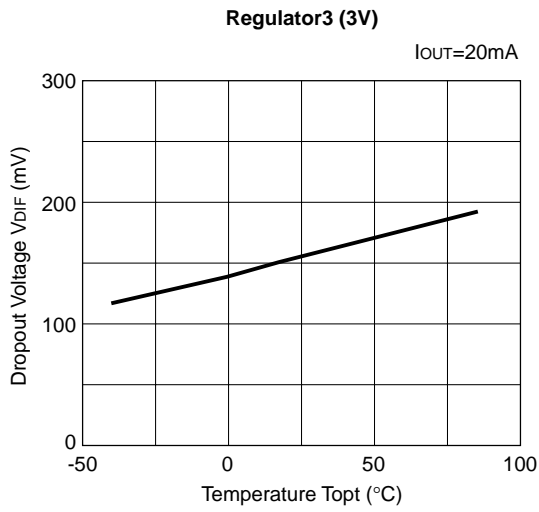

4) Standby Current vs. Temperature
R5310L001B

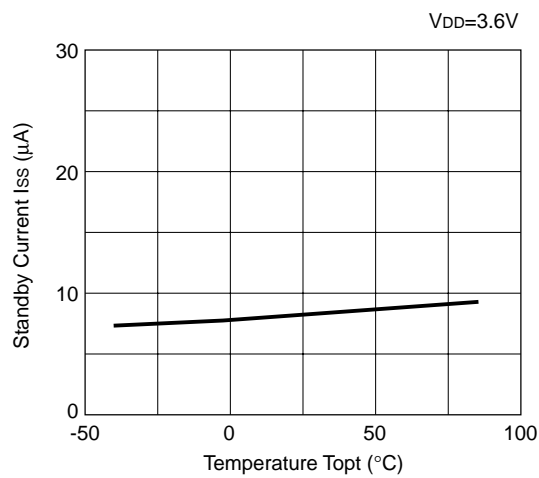

5) Detector Threshold Level and Released Voltage vs. Temperature

Detector1 (2.7V)

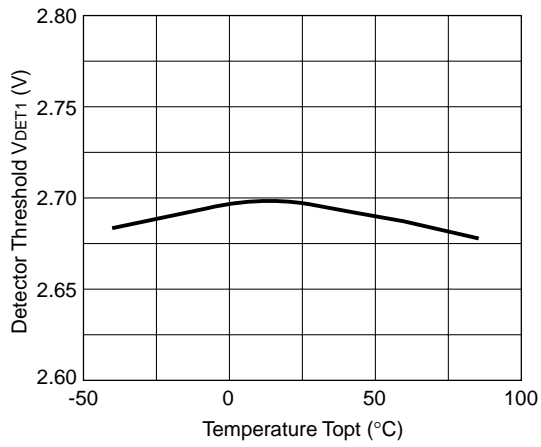

Detector2 (3.0V)

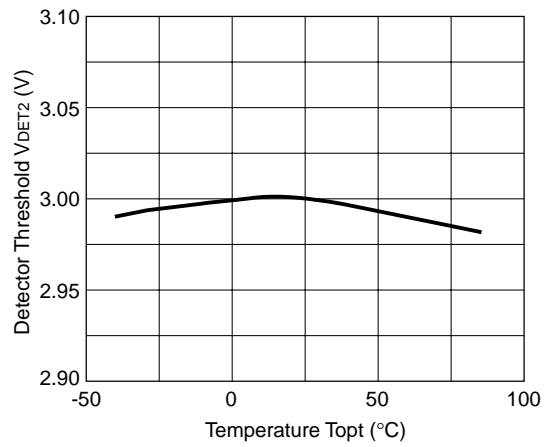

Detector3 (6.3V)

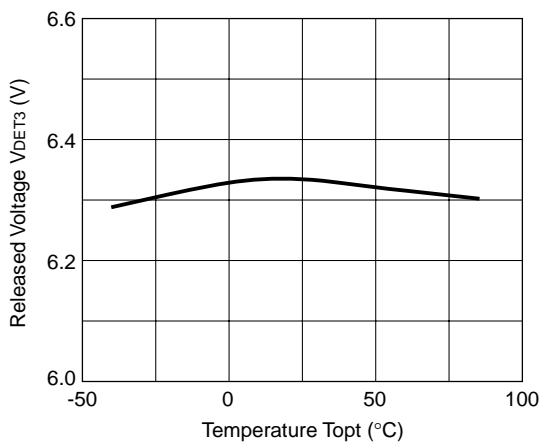

6) Detector1 Power-on Reset Delay Time vs. Temperature

Detector1 (2.7V)

V_{DD}=3.6V C_D=0.15μF

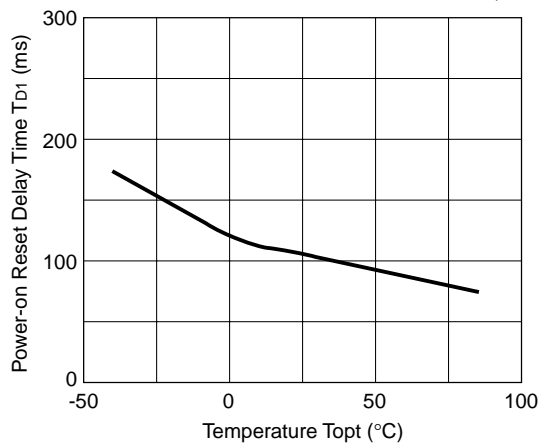

7) Digital Input-Output Resistance vs. Temperature

Pull-up Resistance

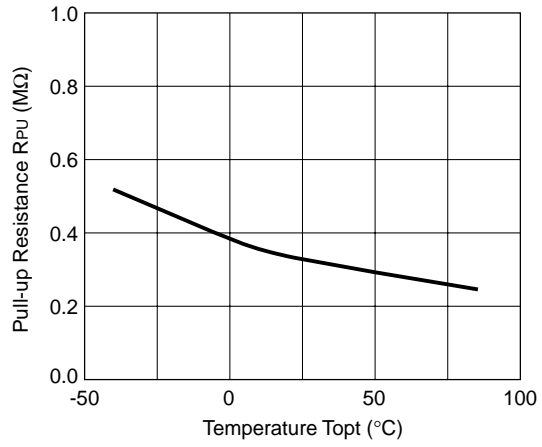

Pull-down Resistance

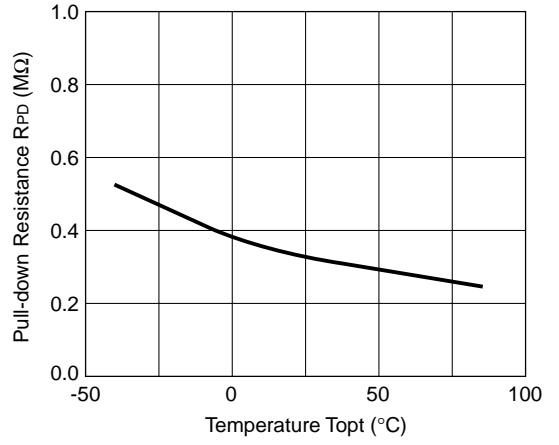

TYPICAL APPLICATION

R5310LxxxB

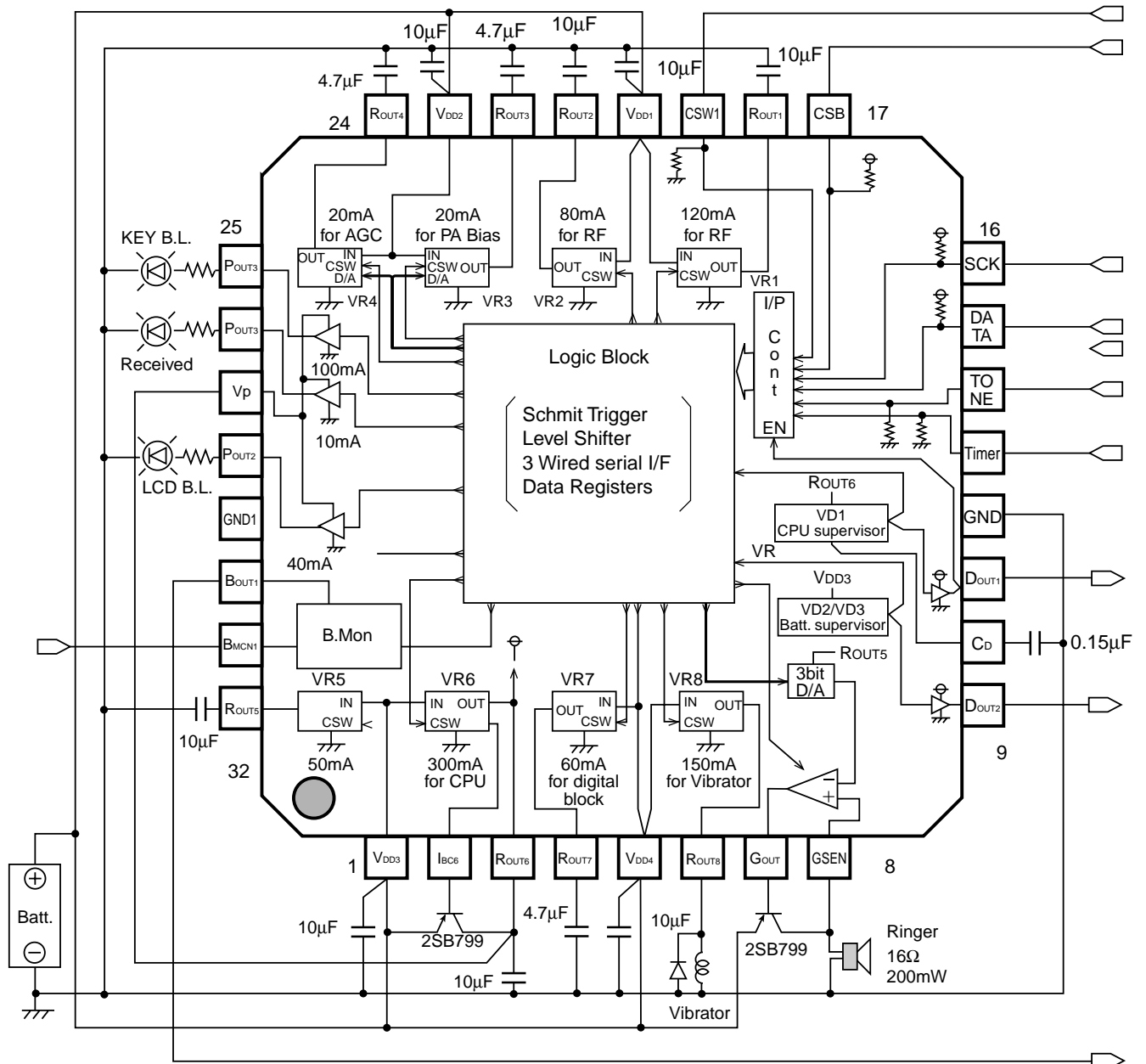

■ PACKAGE DIMENSION

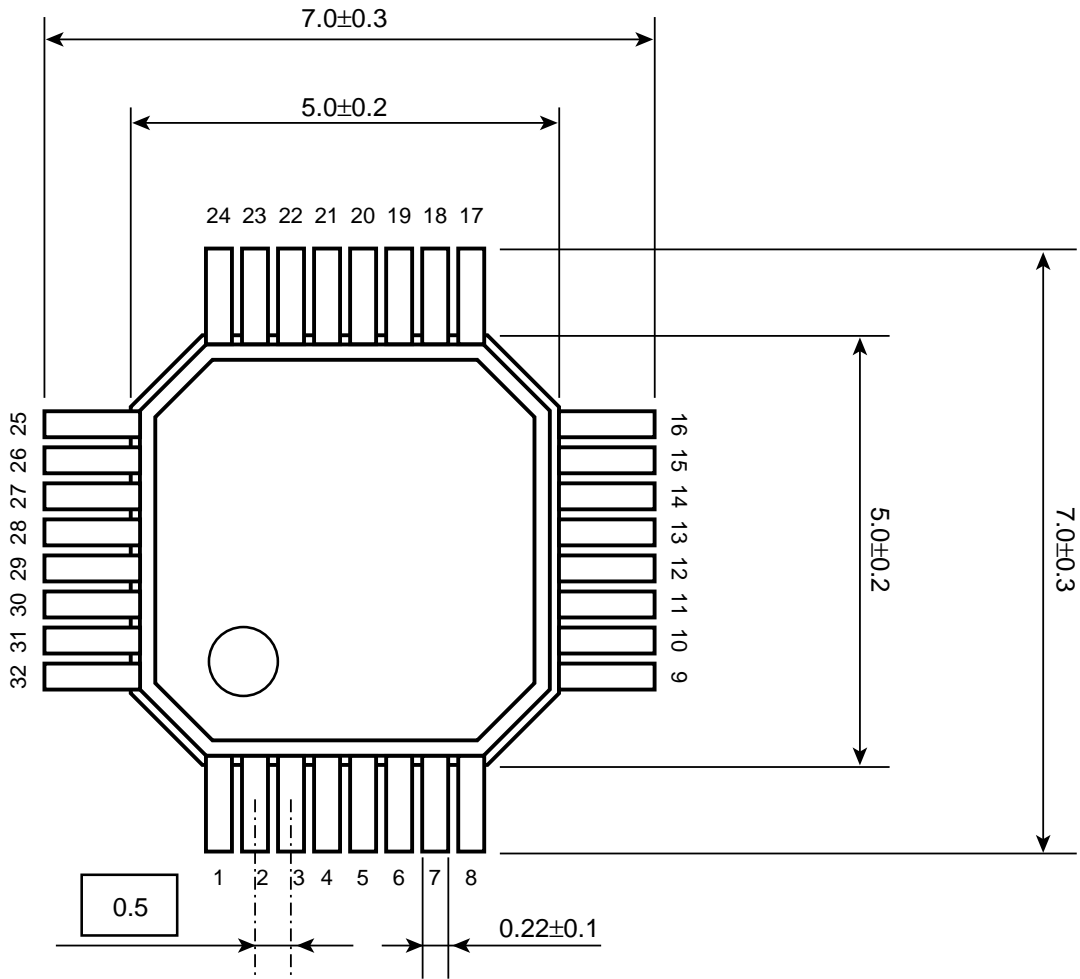

t=1.7 Max
unit : mm