



ELECTROSTATIC SENSITIVE DEVICE
OBSERVE HANDLING PRECAUTIONS

MITSUBISHI RF POWER MOS FET

RD70HHF1

Silicon MOSFET Power Transistor 30MHz,70W

DESCRIPTION

RD70HHF1 is a MOS FET type transistor specifically designed for HF High power amplifiers applications.

FEATURES

- High power and High Gain:
Pout>70W, Gp>13dB @Vdd=12.5V,f=30MHz
- High Efficiency: 60%typ.on HF Band

APPLICATION

For output stage of high power amplifiers in HF Band mobile radio sets.

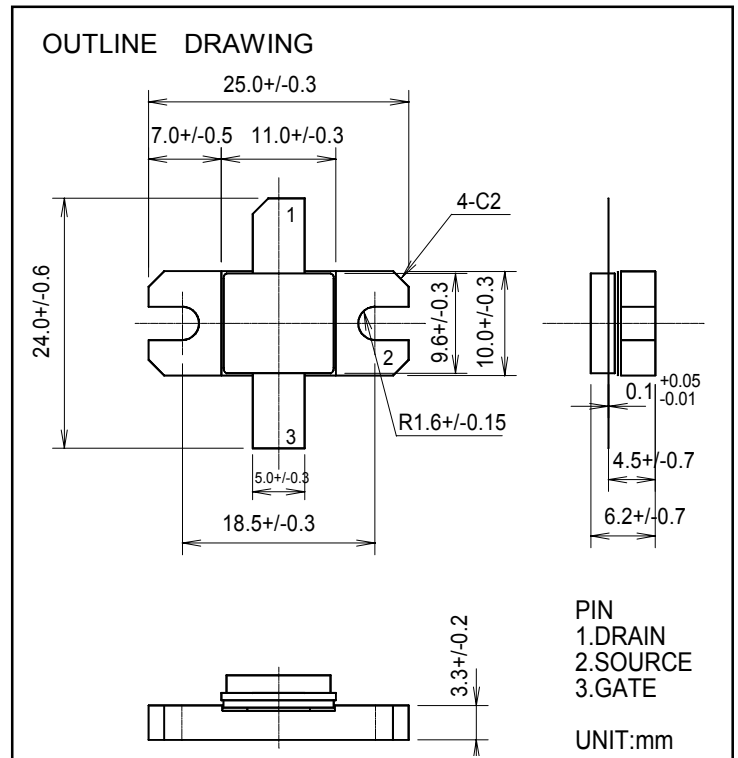

ABSOLUTE MAXIMUM RATINGS

(Tc=25°C UNLESS OTHERWISE NOTED)

SYMBOL	PARAMETER	CONDITIONS	RATINGS	UNIT
V _{DSS}	Drain to source voltage	V _{GS} =0V	50	V
V _{GSS}	Gate to source voltage	V _{DS} =0V	+/-20	V
P _{ch}	Channel dissipation	T _c =25°C	150	W
P _{in}	Input power	Z _g =Z _l =50Ω	5	W
I _D	Drain current	-	20	A
T _{ch}	Channel Temperature	-	175	°C
T _{stg}	Storage temperature	-	-40 to +175	°C
R _{th j-c}	Thermal resistance	junction to case	1.0	°C/W

Note 1: Above parameters are guaranteed independently.

ELECTRICAL CHARACTERISTICS (Tc=25deg.C , UNLESS OTHERWISE NOTED)

SYMBOL	PARAMETER	CONDITIONS	LIMITS			UNIT
			MIN	TYP	MAX.	
I _{DSS}	Zero gate voltage drain current	V _{DS} =17V, V _{GS} =0V	-	-	10	μA
I _{GSS}	Gate to source leak current	V _{GS} =10V, V _{DS} =0V	-	-	1	μA
V _{TH}	Gate threshold voltage	V _{DS} =12V, I _{DS} =1mA	1.5	-	4.5	V
P _{out}	Output power	f=30MHz, V _{DD} =12.5V	70	80	-	W
η _D	Drain efficiency	P _{in} =3.5W, I _{dq} =1.0A	55	60	-	%
	Load VSWR tolerance	V _{DD} =15.2V, P _o =70W (Pin Control) f=30MHz, I _{dq} =1.0A, Z _g =50Ω Load VSWR=20:1 (All Phase)	No destroy			-

Note : Above parameters , ratings , limits and conditions are subject to change.



ELECTROSTATIC SENSITIVE DEVICE
OBSERVE HANDLING PRECAUTIONS

MITSUBISHI RF POWER MOS FET

RD70HHF1

Silicon MOSFET Power Transistor 30MHz,70W

TYPICAL CHARACTERISTICS

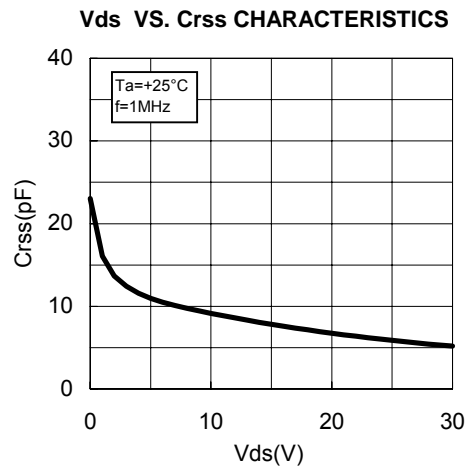
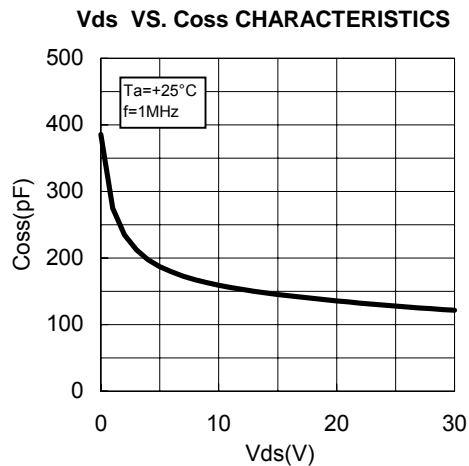
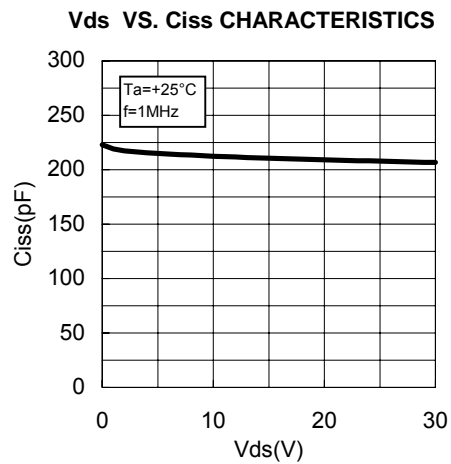
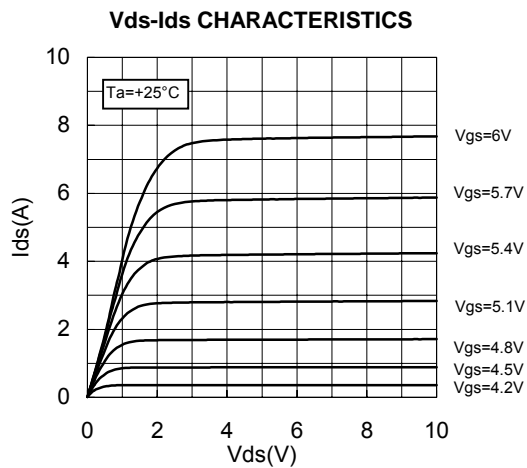
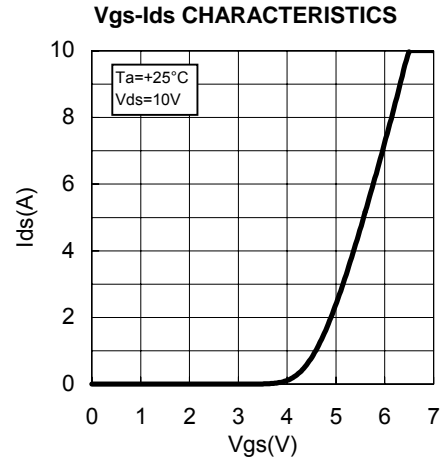
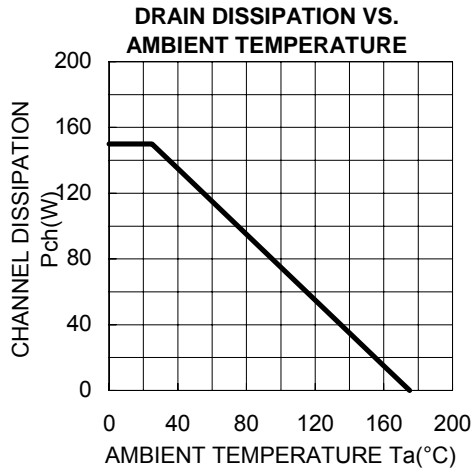



ELECTROSTATIC SENSITIVE DEVICE
OBSERVE HANDLING PRECAUTIONS

MITSUBISHI RF POWER MOS FET

RD70HHF1

Silicon MOSFET Power Transistor 30MHz,70W

TYPICAL CHARACTERISTICS

Pin-Po CHARACTERISTICS

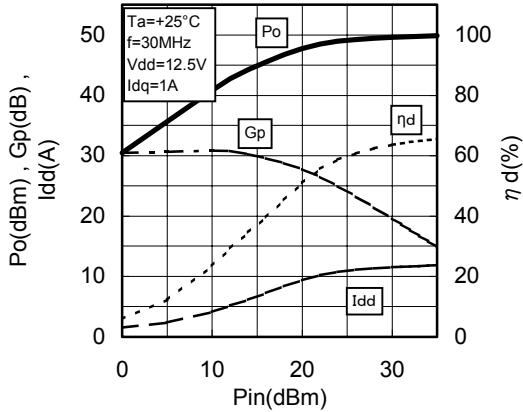

Pin-Po CHARACTERISTICS

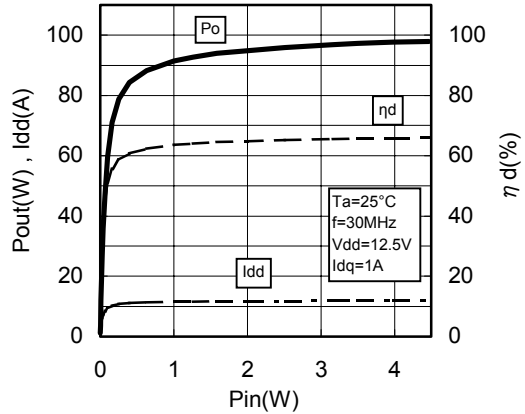

Vdd-Po CHARACTERISTICS

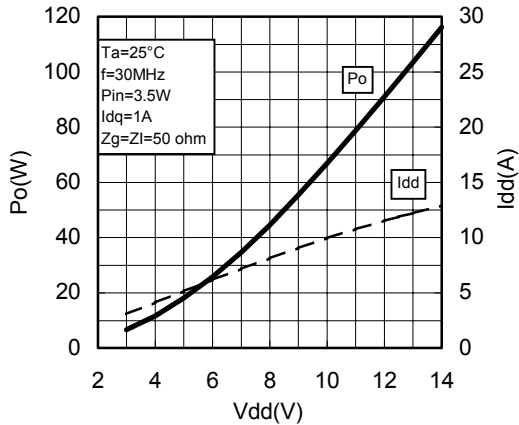

Vgs-Ids CHARACTERISTICS 2

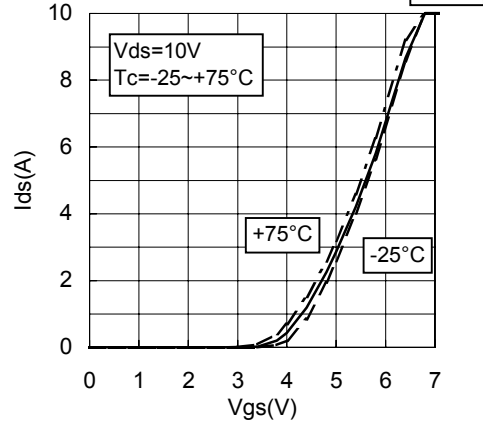

Vgs-gm CHARACTERISTICS

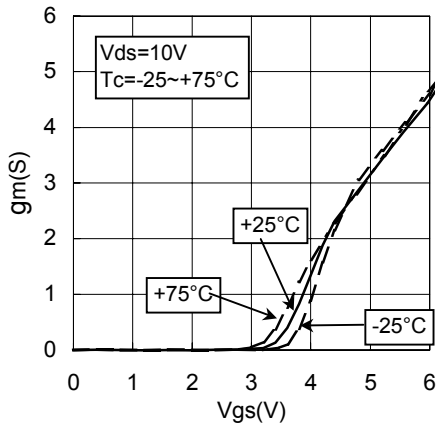

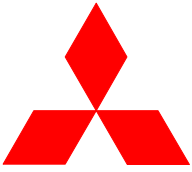

ELECTROSTATIC SENSITIVE DEVICE
OBSERVE HANDLING PRECAUTIONS

MITSUBISHI RF POWER MOS FET

RD70HHF1

Silicon MOSFET Power Transistor 30MHz,70W

TEST CIRCUIT(f=30MHz)

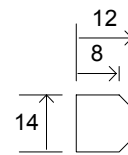
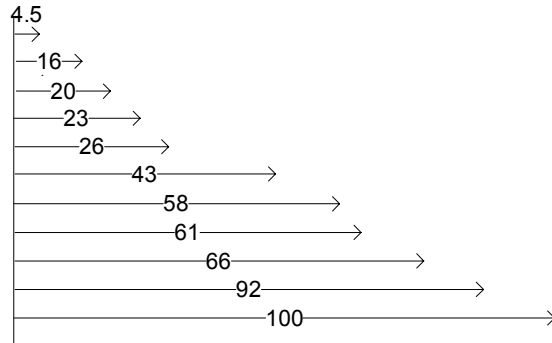
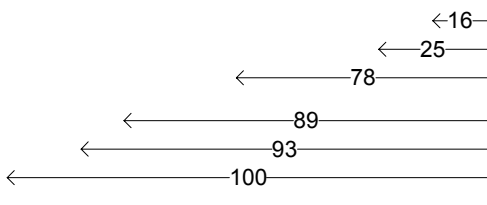
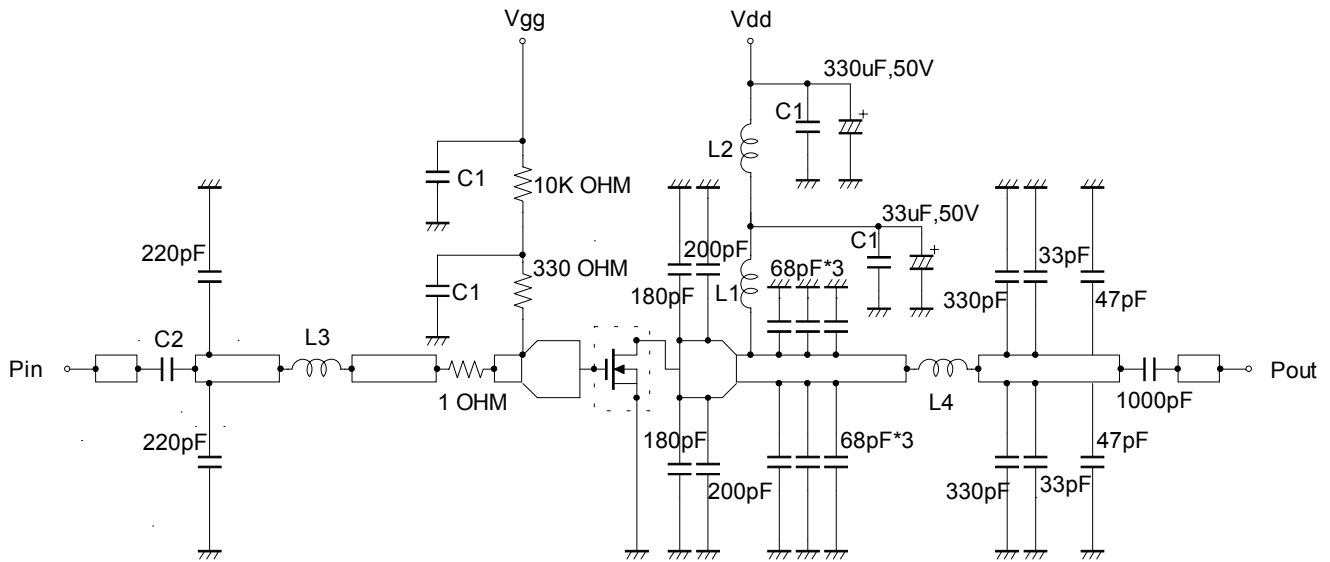

C1:100pF, 0.022uF, 0.1uF in parallel
C2:470uF*2 in parallel

L1:8Turns, l.D8mm, D1.6mm silver plated copper wire
L2:10Turns, l.D8mm, D1.6mm silver plated copper wire
L3:5Turns, l.D6mm, D0.7mm copper wire P=0.5mm
L4:1Turns, l.D10mm, D1.6mm silver plated copper wire

Dimensions:mm

Note:Board material-teflon substrate

micro strip line width=4.2mm / 50 OHM, er:2.7, t=1.6mm



ELECTROSTATIC SENSITIVE DEVICE
OBSERVE HANDLING PRECAUTIONS

MITSUBISHI RF POWER MOS FET

RD70HHF1

Silicon MOSFET Power Transistor 30MHz,70W

INPUT/OUTPUT IMPEDANCE VS.FREQUENCY CHARACTERISTICS

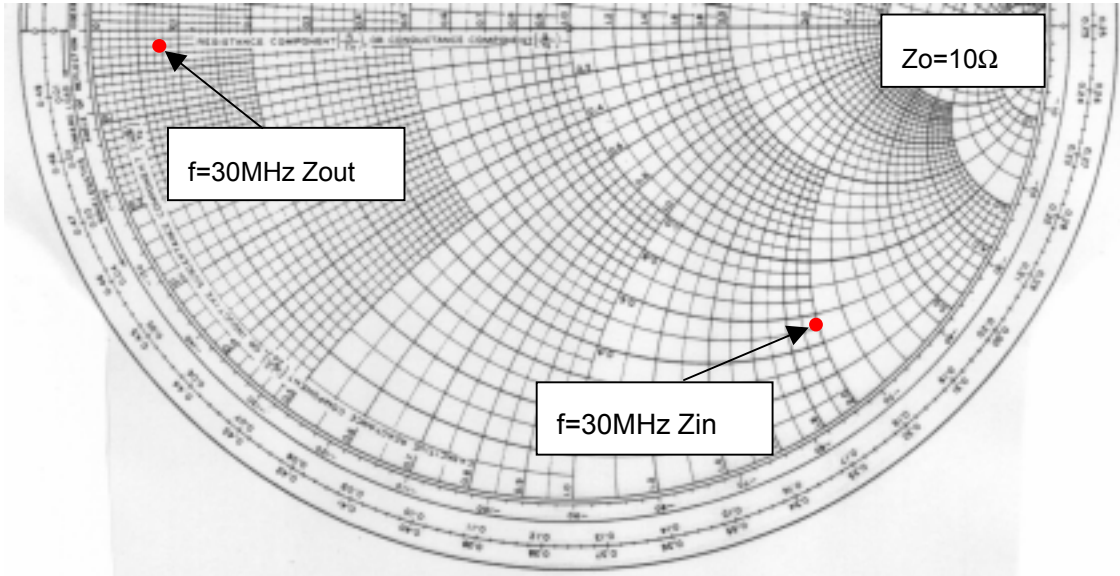

Zin , Zout

f (MHz)	Zin (ohm)	Zout (ohm)	Conditions
30	5.28-j20.08	0.77-j0.22	



ELECTROSTATIC SENSITIVE DEVICE
OBSERVE HANDLING PRECAUTIONS

MITSUBISHI RF POWER MOS FET

RD70HHF1

Silicon MOSFET Power Transistor 30MHz,70W

RD70HHF1 S-PARAMETER DATA (@V_{dd}=12.5V, I_d=800mA)

Freq. [MHz]	S11		S21		S12		S22	
	(mag)	(ang)	(mag)	(ang)	(mag)	(ang)	(mag)	(ang)
10	0.837	-155.8	39.860	97.0	0.013	2.0	0.776	-159.3
30	0.838	-170.6	13.625	82.2	0.012	-8.7	0.770	-171.5
50	0.842	-173.0	8.074	75.1	0.012	-7.4	0.784	-171.7
100	0.872	-174.1	3.731	60.3	0.010	-24.2	0.824	-171.3
150	0.899	-174.9	2.183	47.0	0.009	-41.5	0.864	-173.2
200	0.917	-175.9	1.408	38.4	0.007	-39.3	0.893	-173.6
250	0.931	-176.8	1.010	31.6	0.006	-23.3	0.931	-175.3
300	0.941	-177.7	0.734	25.1	0.005	-46.3	0.931	-176.5
350	0.950	-178.6	0.570	21.5	0.004	-17.5	0.944	-177.5
400	0.953	-179.4	0.455	17.2	0.003	29.2	0.964	-178.6
450	0.957	179.9	0.361	13.3	0.003	-4.5	0.952	-179.5
500	0.960	179.1	0.302	11.1	0.001	105.8	0.959	179.4
550	0.967	178.4	0.254	7.3	0.004	65.8	0.966	178.4
600	0.967	177.7	0.211	7.4	0.003	96.5	0.962	178.0
650	0.971	177.3	0.185	5.8	0.006	71.6	0.973	177.0
700	0.969	176.5	0.162	0.5	0.005	96.8	0.969	176.0
750	0.970	175.6	0.160	2.7	0.005	72.1	0.965	175.7
800	0.969	175.1	0.132	1.8	0.007	81.0	0.976	174.6
850	0.974	174.8	0.122	-4.3	0.007	73.6	0.970	174.4
900	0.973	174.0	0.117	-5.2	0.009	87.1	0.970	174.0
950	0.971	173.1	0.100	0.0	0.011	77.5	0.972	172.7
1000	0.976	172.5	0.087	-0.5	0.011	73.8	0.972	172.6



ELECTROSTATIC SENSITIVE DEVICE
OBSERVE HANDLING PRECAUTIONS

MITSUBISHI RF POWER MOS FET

RD70HHF1

Silicon MOSFET Power Transistor 30MHz,70W

Keep safety first in your circuit designs!

Mitsubishi Electric Corporation puts the maximum effort into making semiconductor products better and more reliable, but there is always the possibility that trouble may occur with them. Trouble with semiconductors may lead to personal injury, fire or property damage. Remember to give due consideration to safety when making your circuit designs, with appropriate measures such as (i) placement of substitutive, auxiliary circuits, (ii) use of non-flammable material or (iii) prevention against any malfunction or mishap.