

RD9

*TinySwitch*TM

Flyback Prototyping Board

User Configurable Input and Output Voltages



Product Highlights

Unpopulated Prototyping Board

- Complete layout for construction of *TinySwitch* flyback supply
- Convenient prototyping area on secondary side of board
- Single-sided construction
- RD9 boards can be combined for rapid prototyping with RD8 (available separately)

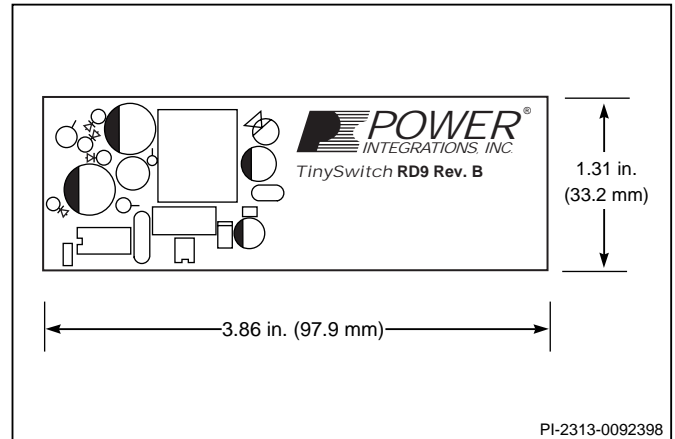

Figure 1. RD9 Board Overall Physical Dimensions.

Description

The RD9 is a special printed circuit board (Figure 1) designed for rapid prototyping of *TinySwitch*-based flyback power supplies in the 1-3 W range. Component positions and an optimized layout are provided for a complete single output power supply as shown in Figure 2. Component size and placement are identical to evaluation board RD8. The board is designed to accommodate a transformer using an EE16 core with a 10 pin bobbin (Ying Chin YC-1607 or equivalent*). In addition to the power supply circuitry, the RD9 also provides a prototyping area on the secondary side of the board for circuitry such as additional outputs or voltage and current regulators. Some typical application circuits that can be constructed using the RD9 printed circuit board can be found in the *TinySwitch* and RD8 data sheets, and Design Ideas DI-4 through DI-8.

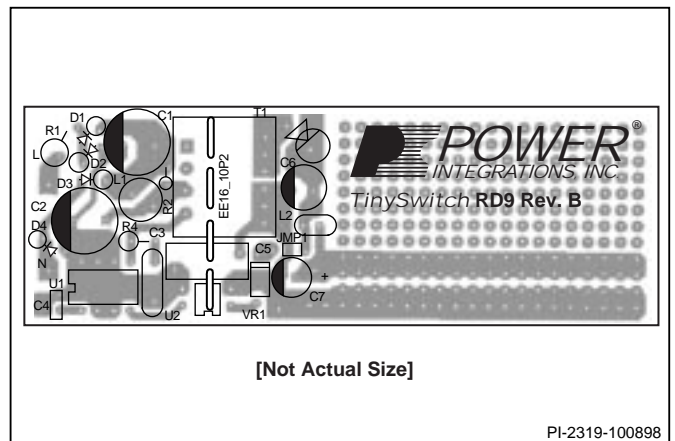

Figure 2. PC Board Layout of the RD9.

For extremely rapid prototyping, the RD8 *TinySwitch* evaluation board and the RD9 prototyping board are perforated between the primary and secondary circuit areas, so that the primary half of the RD8 can be separated and combined with the secondary half of the RD9.

* Available from B&B Products Corp +1 (520) 884-4818

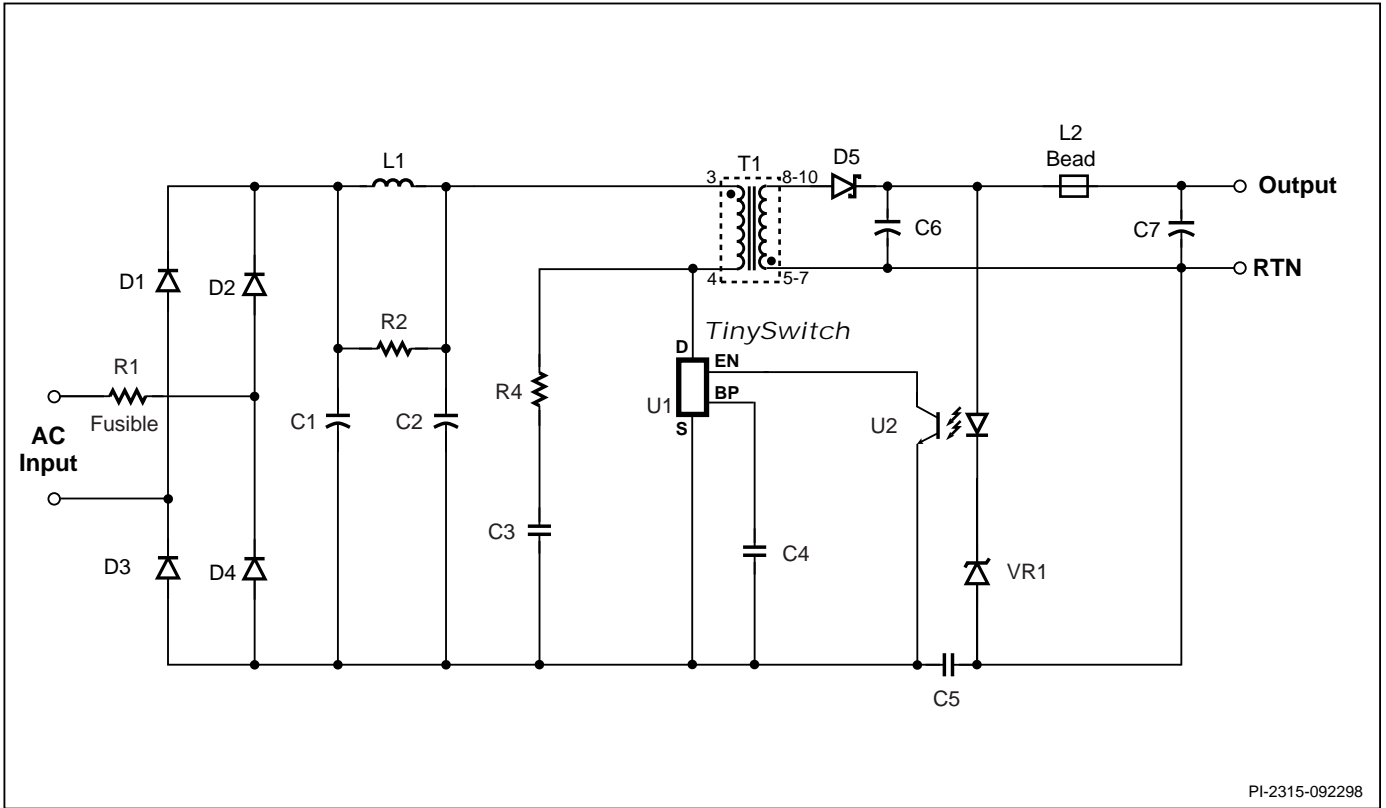

Figure 3. Schematic Diagram of a Typical RD9 Circuit.

Using RD8 and RD9 Together

A complete RD9 board is shown in Figure 4, and an RD8 board in Figure 5. To combine the secondary side of RD9 with the primary side of RD8, follow the instructions below:

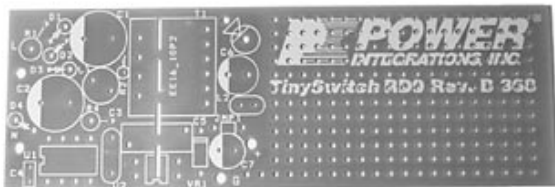

Figure 4. RD9 Printed Circuit Board.

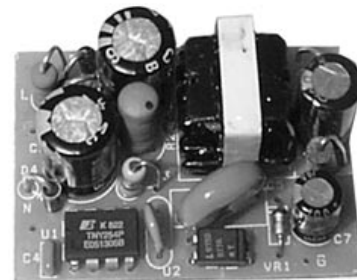

Figure 5. RD8 Printed Circuit Board.

- Break the RD9 board along the perforations to separate the primary and secondary halves. The secondary half of the board contains the prototyping area (Figure 6).

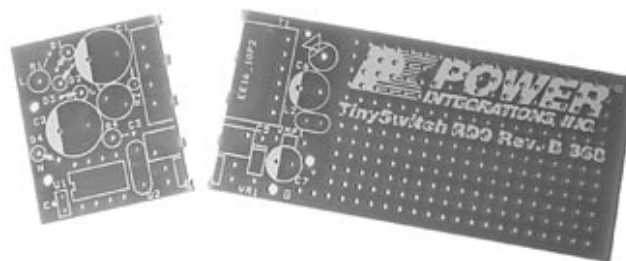

Figure 6. Prepared RD9 Board.

- Prepare the RD8 board by removing T1, C5, and U2. Set these aside for reuse. Break the board along the perforations to separate the primary and secondary circuitry. The board should then look as shown in Figure 7.

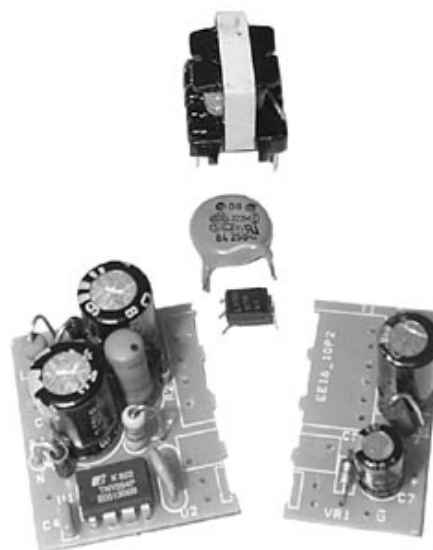

Figure 7. Prepared RD8 Board.

- Fit the primary half of RD8 and the secondary half of RD9 together, using T1, C5, and U2 removed from the RD8 board to bridge between the two board halves (Figure 8). A different transformer can be substituted for T1. Use the cores and bobbins suggested in the text for best mechanical fit.

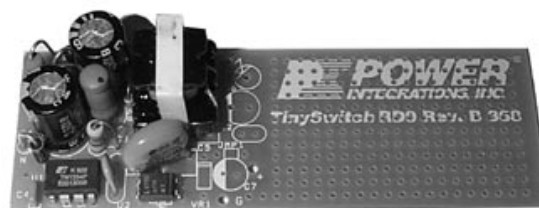

Figure 8. Combined RD8 and RD9.

For the latest updates, visit our website: www.powerint.com

Power Integrations reserves the right to make changes to its products at any time to improve reliability or manufacturability. Power Integrations does not assume any liability arising from the use of any device or circuit described herein, nor does it convey any license under its patent rights or the rights of others.

PI Logo and *TOPSwitch* are registered trademarks of Power Integrations, Inc.

©Copyright 1998, Power Integrations, Inc. 477 N. Mathilda Avenue, Sunnyvale, CA 94086

WORLD HEADQUARTERS

NORTH AMERICA - WEST

Power Integrations, Inc.
477 N. Mathilda Avenue
Sunnyvale, CA 94086 USA
Main: +1•408•523•9200
Customer Service:
Phone: +1•408•523•9265
Fax: +1•408•523•9365

NORTH AMERICA - EAST & SOUTH AMERICA

Power Integrations, Inc.
Eastern Area Sales Office
1343 Canton Road, Suite C1
Marietta, GA 30066 USA
Phone: +1•770•424•5152
Fax: +1•770•424•6567

EUROPE & AFRICA

Power Integrations (Europe) Ltd.
Mountbatten House
Fair Acres Windsor
Berkshire SL4 4LE,
United Kingdom
Phone: +44•1753•622•208
Fax: +44•1753•622•209

TAIWAN

Power Integrations International
Holdings, Inc.
2F, #508, Chung Hsiao E. Rd., Sec. 5,
Taipei 105, Taiwan
Phone: +886•2•2727•1221
Fax: +886•2•2727•1223

KOREA

Power Integrations International
Holdings, Inc.
Rm# 402, Handuk Building,
649-4 Yeoksam-Dong, Kangnam-Gu,
Seoul, Korea
Phone: +82•2•568•7520
Fax: +82•2•568•7474

JAPAN

Power Integrations, K.K.
Keihin-Tatemono 1st Bldg.
12-20 Shin-Yokohama 2-Chome,
Kohoku-ku, Yokohama-shi,
Kanagawa 222, Japan
Phone: +81•45•471•1021
Fax: +81•45•471•3717

INDIA (Technical Support)

Innovatech
#1, 8th Main Road
Vasanthnagar
Bangalore 560052, India
Phone: +91•80•226•6023
Fax: +91•80•228•2191

APPLICATIONS HOTLINE

World Wide +1•408•523•9260

APPLICATIONS FAX

World Wide +1•408•523•9361

