

70A, 60V, Avalanche Rated, N-Channel Enhancement-Mode Power MOSFETs

December 1995

Features

- 70A, 60V
- $r_{DS(on)} = 0.014\Omega$
- *Temperature Compensated PSPICE Model*
- *Peak Current vs Pulse Width Curve*
- *UIS Rating Curve (Single Pulse)*
- +175°C Operating Temperature

Description

The RFG70N06, RFP70N06, RF1S70N06 and RF1S70N06SM are N-channel power MOSFETs manufactured using the MegaFET process. This process, which uses feature sizes approaching those of LSI circuits, gives optimum utilization of silicon, resulting in outstanding performance. They were designed for use in applications such as switching regulators, switching converters, motor drivers and relay drivers. These transistors can be operated directly from integrated circuits.

PACKAGE AVAILABILITY

PART NUMBER	PACKAGE	BRAND
RFG70N06	TO-247	RFG70N06
RFP70N06	TO-220AB	RFP70N06
RF1S70N06	TO-262AA	F1S70N06
RF1S70N06SM	TO-263AB	F1S70N06

NOTE: When ordering use the entire part number. Add the suffix, 9A, to obtain the TO-263AB variant in tape and reel, e.g. RF1S70N06SM9A.

Formerly developmental type TA49007.

Symbol

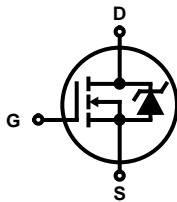

Packages

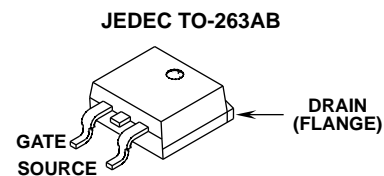
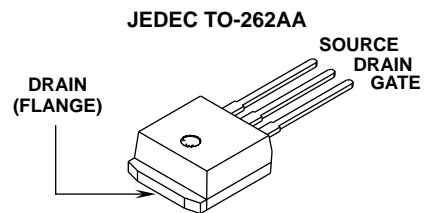
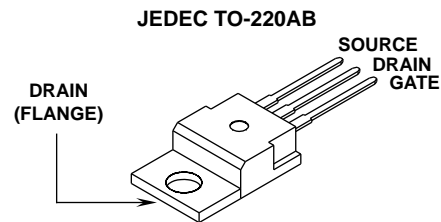
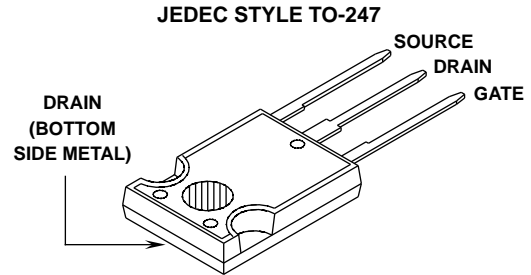

Absolute Maximum Ratings $T_C = +25^\circ\text{C}$, Unless Otherwise Specified

	RFG70N06, RFP70N06 RF1S70N06, RF1S70N06SM	UNITS
Drain Source Voltage	60	V
Drain Gate Voltage	60	V
Gate Source Voltage	± 20	V
Drain Current		
RMS Continuous	70	A
Pulsed Drain Current	Refer to Peak Current Curve	
Single Pulse Avalanche Rating	Refer to UIS Curve	
Power Dissipation		
$T_C = +25^\circ\text{C}$	150	W
Derate above $+25^\circ\text{C}$	1.0	W/ $^\circ\text{C}$
Operating and Storage Temperature	-55 to +175	$^\circ\text{C}$

Specifications RFG70N06, RFP70N06, RF1S70N06, RF1S70N06SM

Electrical Specifications $T_C = +25^\circ\text{C}$, Unless Otherwise Specified

PARAMETER	SYMBOL	TEST CONDITIONS	MIN	TYP	MAX	UNITS	
Drain-Source Breakdown Voltage	BV_{DSS}	$I_D = 250\mu\text{A}$, $V_{GS} = 0\text{V}$	60	-	-	V	
Gate Threshold Voltage	$V_{GS(TH)}$	$V_{GS} = V_{DS}$, $I_D = 250\mu\text{A}$	2	-	4	V	
Zero Gate Voltage Drain Current	I_{DSS}	$V_{DS} = 60\text{V}$, $V_{GS} = 0\text{V}$	$T_C = +25^\circ\text{C}$	-	-	1	μA
			$T_C = +150^\circ\text{C}$	-	-	50	μA
Gate-Source Leakage Current	I_{GSS}	$V_{GS} = \pm 20\text{V}$	-	-	100	nA	
On Resistance	$r_{DS(ON)}$	$I_D = 70\text{A}$, $V_{GS} = 10\text{V}$	-	-	0.014	Ω	
Turn-On Time	t_{ON}	$V_{DD} = 30\text{V}$, $I_D = 70\text{A}$ $R_L = 0.43\Omega$, $V_{GS} = +10\text{V}$ $R_{GS} = 2.5\Omega$	-	-	125	ns	
Turn-On Delay Time	$t_{D(ON)}$		-	12	-	ns	
Rise Time	t_R		-	50	-	ns	
Turn-Off Delay Time	$t_{D(OFF)}$		-	40	-	ns	
Fall Time	t_F		-	15	-	ns	
Turn-Off Time	t_{OFF}		-	-	125	ns	
Total Gate Charge	$Q_{G(TOT)}$		$V_{GS} = 0\text{V}$ to 20V	$V_{DD} = 48\text{V}$, $I_D = 70\text{A}$, $R_L = 0.68\Omega$	-	185	215
Gate Charge at 10V	$Q_{G(10)}$	$V_{GS} = 0\text{V}$ to 10V	-		100	115	nC
Threshold Gate Charge	$Q_{G(TH)}$	$V_{GS} = 0\text{V}$ to 2V	-		5.5	6.5	nC
Input Capacitance	C_{ISS}	$V_{DS} = 25\text{V}$, $V_{GS} = 0\text{V}$ $f = 1\text{MHz}$	-	3000	-	pF	
Output Capacitance	C_{OSS}		-	900	-	pF	
Reverse Transfer Capacitance	C_{RSS}		-	300	-	pF	
Thermal Resistance Junction to Case	$R_{\theta JC}$		-	-	1.0	$^\circ\text{C/W}$	
Thermal Resistance Junction to Ambient	$R_{\theta JA}$		-	-	80	$^\circ\text{C/W}$	

Source-Drain Diode Specifications

PARAMETER	SYMBOL	TEST CONDITIONS	MIN	TYP	MAX	UNITS
Forward Voltage	V_{SD}	$I_{SD} = 70\text{A}$	-	-	1.5	V
Reverse Recovery Time	t_{RR}	$I_{SD} = 70\text{A}$, $dI_{SD}/dt = 100\text{A}/\mu\text{s}$	-	-	125	ns

Typical Performance Curves

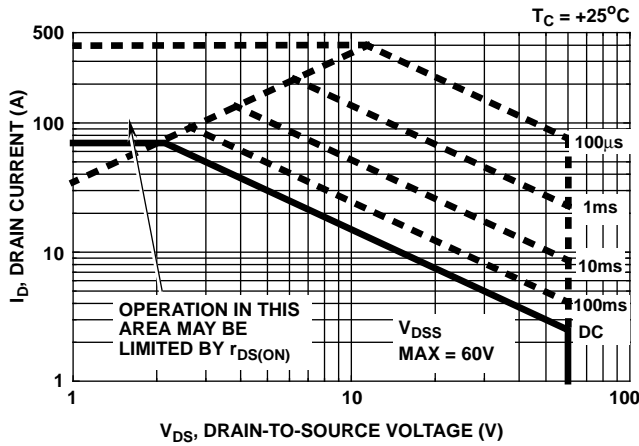

FIGURE 1. SAFE OPERATING AREA CURVE

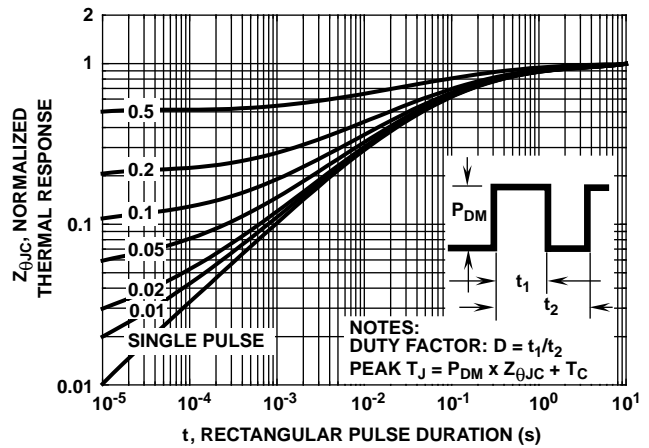

FIGURE 2. NORMALIZED MAXIMUM TRANSIENT THERMAL IMPEDANCE

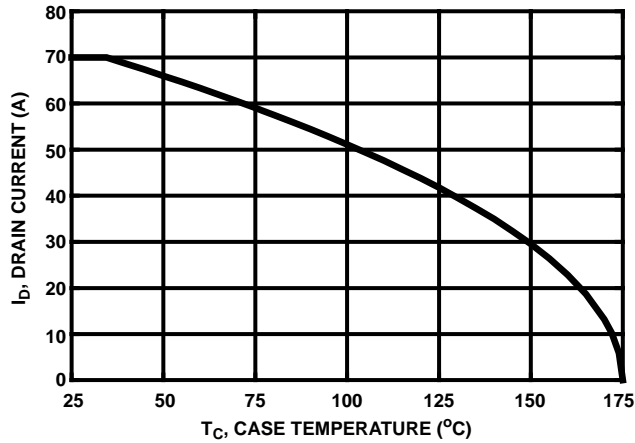

FIGURE 3. MAXIMUM CONTINUOUS DRAIN CURRENT vs TEMPERATURE

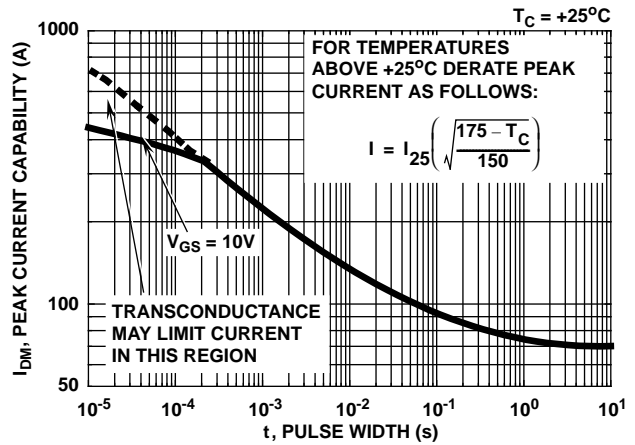

FIGURE 4. PEAK CURRENT CAPABILITY

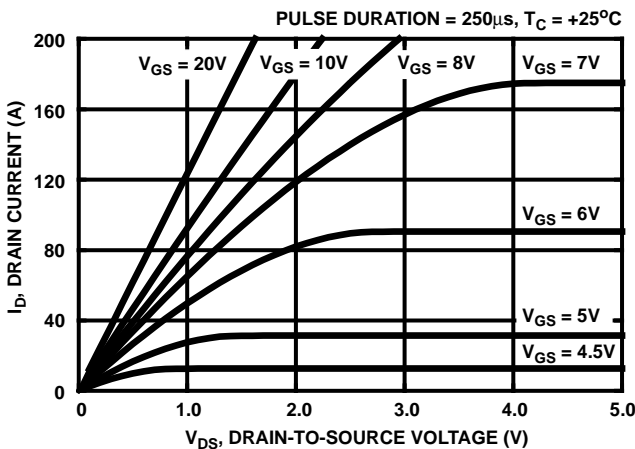

FIGURE 5. TYPICAL SATURATION CHARACTERISTICS

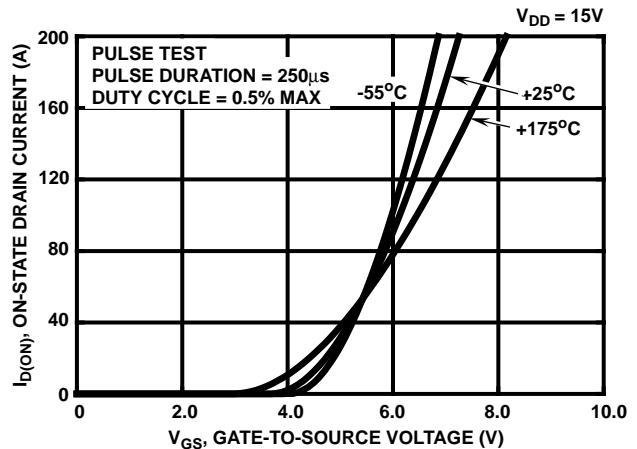

FIGURE 6. TYPICAL TRANSFER CHARACTERISTICS

Typical Performance Curves (Continued)

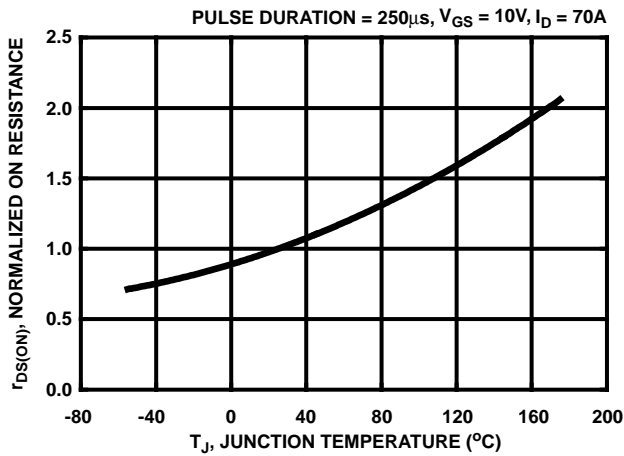

FIGURE 7. NORMALIZED $r_{DS(ON)}$ vs JUNCTION TEMPERATURE

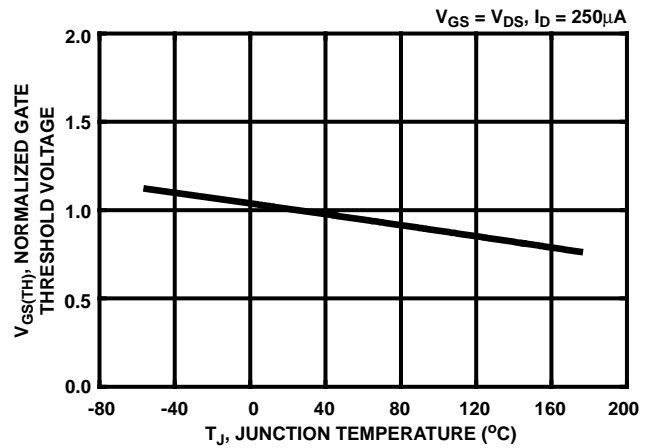

FIGURE 8. NORMALIZED GATE THRESHOLD VOLTAGE vs JUNCTION TEMPERATURE

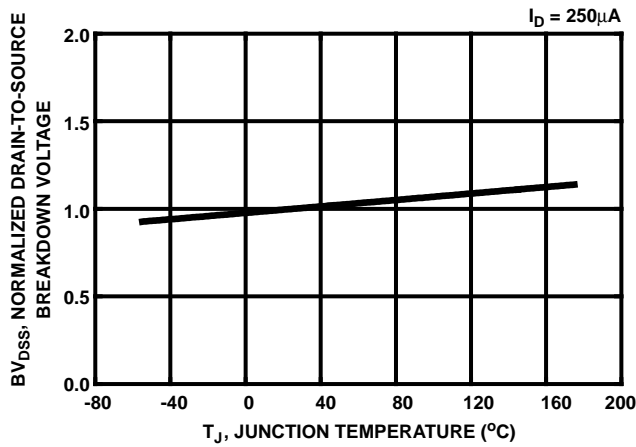

FIGURE 9. NORMALIZED DRAIN-SOURCE BREAKDOWN VOLTAGE vs JUNCTION TEMPERATURE

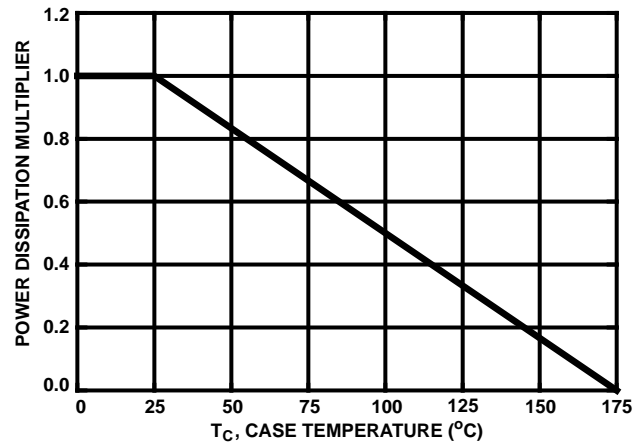

FIGURE 10. NORMALIZED POWER DISSIPATION vs TEMPERATURE DERATING CURVE

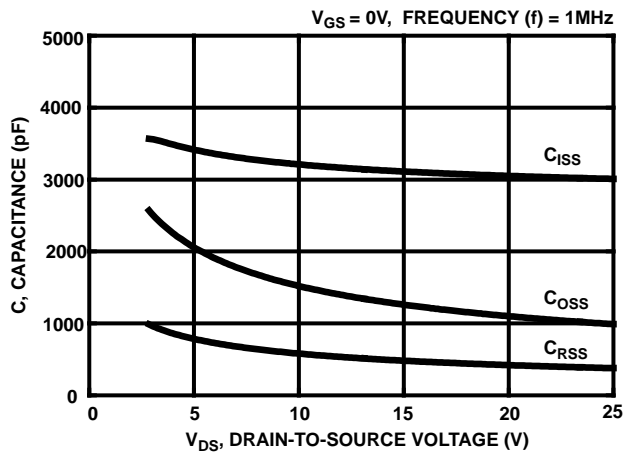

FIGURE 11. TYPICAL CAPACITANCE vs VOLTAGE

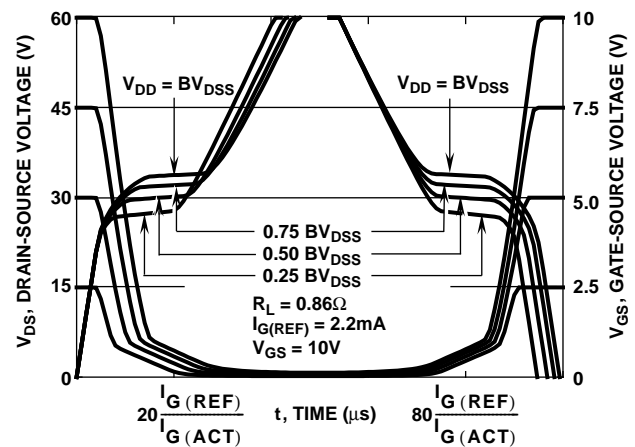

FIGURE 12. NORMALIZED SWITCHING WAVEFORMS FOR CONSTANT GATE CURRENT. REFER TO HARRIS APPLICATION NOTES AN7254 AND AN7260

Typical Performance Curves (Continued)

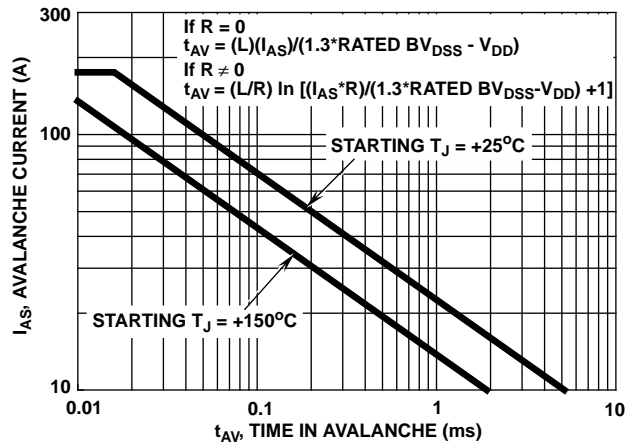

FIGURE 13. UNCLAMPED INDUCTIVE SWITCHING

REFER TO HARRIS APPLICATION NOTES AN9321 AND AN9322

Test Circuits and Waveforms

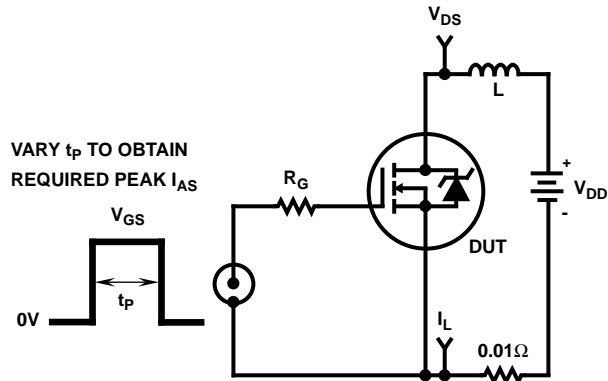

FIGURE 14. UNCLAMPED ENERGY TEST CIRCUIT

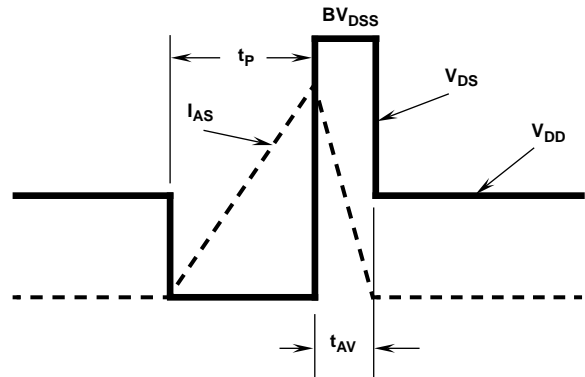

FIGURE 15. UNCLAMPED ENERGY WAVEFORMS

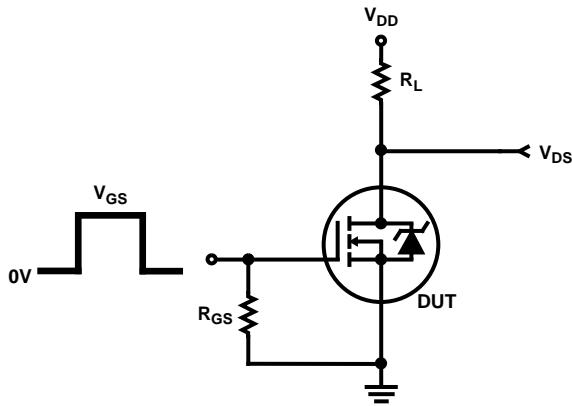

FIGURE 16. RESISTIVE SWITCHING TEST CIRCUIT

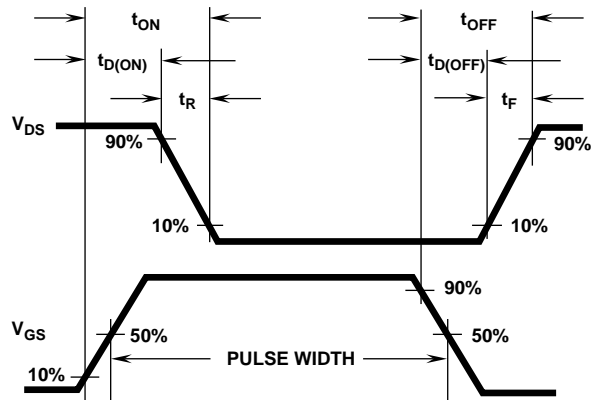

FIGURE 17. RESISTIVE SWITCHING WAVEFORMS

RFG70N06, RFP70N06, RF1S70N06, RF1S70N06SM

Temperature Compensated PSPICE Model for the RFG70N06, RFP70N06, RF1S70N06, RF1S70N06SM

.SUBCKT RFG70N06 2 1 3; rev 3/20/92

CA 12 8 5.56e-9
CB 15 14 5.30e-9
CIN 6 8 2.63e-9

DBODY 7 5 DBDMOD
DBREAK 5 11 DBKMOD
DPLCAP 10 5 DPLCAPMOD

EBREAK 11 7 17 18 65.18
EDS 14 8 5 8 1
EGS 13 8 6 8 1
ESG 6 10 6 8 1
EVTO 20 6 18 8 1

IT 8 17 1

LDRAIN 2 5 1e-9
LGATE 1 9 3.10e-9
LSOURCE 3 7 1.82e-9

MOS1 16 6 8 8 MOSMOD M = 0.99
MOS2 16 21 8 8 MOSMOD M = 0.01

RBREAK 17 18 RBKMOD 1
RDRAIN 50 16 RDSMOD 4.66e-3
RLDRAIN 2 5 10
RGATE 9 20 1.21
RLGATE 1 9 31
RIN 6 8 1e9
RSOURCE 8 7 RDSMOD 3.92e-3
RLSOURCE 3 7 18.2
RVTO 18 19 RVTOMOD 1

S1A 6 12 13 8 S1AMOD
S1B 13 12 13 8 S1BMOD
S2A 6 15 14 13 S2AMOD
S2B 13 15 14 13 S2BMOD

VBAT 8 19 DC 1
VTO 21 6 0.605

.MODEL DBDMOD D (IS = 7.91e-12 RS = 3.87e-3 TRS1 = 2.71e-3 TRS2 = 2.50e-7 CJO = 4.84e-9 TT = 4.51e-8)
.MODEL DBKMOD D (RS = 3.9e-2 TRS1 = 1.05e-4 TRS2 = 3.11e-5)
.MODEL DPLCAPMOD D (CJO = 4.8e-9 IS = 1e-30 N = 10)
.MODEL MOSMOD NMOS (VTO = 3.46 KP = 47 IS = 1e-30 N = 10 TOX = 1 L = 1u W = 1u)
.MODEL RBKMOD RES (TC1 = 8.46e-4 TC2 = -8.48e-7)
.MODEL RDSMOD RES (TC1 = 2.23e-3 TC2 = 6.56e-6)
.MODEL RVTOMOD RES (TC1 = -3.29e-3 TC2 = 3.49e-7)
.MODEL S1AMOD VSWITCH (RON = 1e-5 ROFF = 0.1 VON = -8.35 VOFF = -6.35)
.MODEL S1BMOD VSWITCH (RON = 1e-5 ROFF = 0.1 VON = -6.35 VOFF = -8.35)
.MODEL S2AMOD VSWITCH (RON = 1e-5 ROFF = 0.1 VON = -2.0 VOFF = 3.0)
.MODEL S2BMOD VSWITCH (RON = 1e-5 ROFF = 0.1 VON = 3.0 VOFF = -2.0)

.ENDS

NOTE: For further discussion of the PSPICE model, consult **A New PSPICE Sub-circuit for the Power MOSFET Featuring Global Temperature Options**; written by William J. Hepp and C. Frank Wheatley.

