

Typical Applications

- GSM/DCS Dual-Band Handsets
- Cellular/PCS Dual-Band Handsets
- General Purpose Amplification
- Commercial and Consumer Systems

Product Description

The RF2416 is a dual-band low noise amplifier with bypass switch designed for use as a front-end for 950MHz GSM and DCS1800/PCS1900 applications. It may also be used for dual-band cellular/PCS application. The 900MHz LNA is a single-stage amplifier with bypass switch; the 1800/1900 LNA is a two-stage amplifier with bypass switch. Both amplifiers have excellent noise figure and high linearity in both high gain and bypass/low gain mode. The device is packaged in a 3mmx3mm, 12 pin, leadless chip carrier.

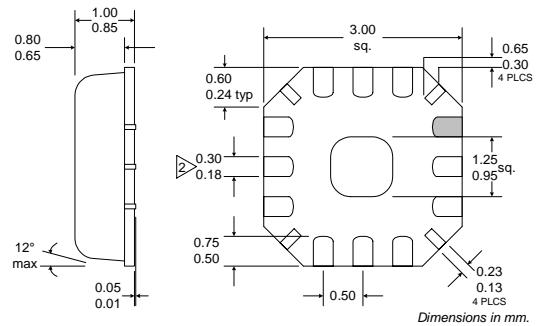

- NOTES:**
- 1 Shaded Pin is Lead 1.
 - 2 Dimension applies to plated terminal and is measured between 0.02 mm and 0.25 mm from terminal end.
 - 3 Pin 1 identifier must exist on top surface of package by identification mark or feature on the package body. Exact shape and size is optional.
 - 4 Package Warpage: 0.05 mm max.
 - 5 Die thickness allowable: 0.305 mm max.

4
GENERAL PURPOSE AMPLIFIERS

Optimum Technology Matching® Applied

- Si BJT GaAs HBT GaAs MESFET
 Si Bi-CMOS SiGe HBT Si CMOS

Package Style: LCC, 12-Pin, 3x3

- Features**
- Low Noise and High Intercept Point
 - Dual-Band Application GSM900 and DCS1800/PCS1900
 - Power Down Control
 - Switchable Gain

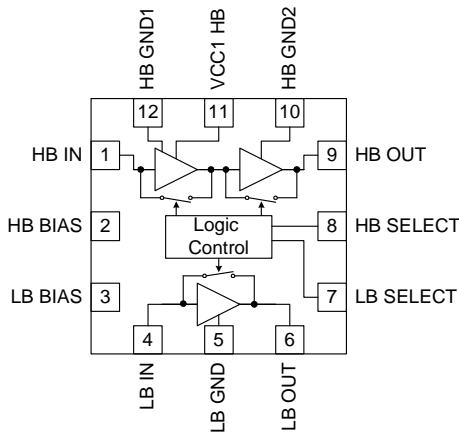

Functional Block Diagram

Ordering Information

RF2416	Dual-Band 2.7V Low Noise Amplifier
RF2416 PCBA	Fully Assembled Evaluation Board

RF Micro Devices, Inc. Tel (336) 664 1233
 7628 Thorndike Road Fax (336) 664 0454
 Greensboro, NC 27409, USA <http://www.rfmd.com>

Absolute Maximum Ratings

Parameter	Rating	Unit
Supply Voltage	-0.5 to +6.0	V _{DC}
Input RF Level	+10	dBm
Storage Temperature	-40 to +150	°C



Caution! ESD sensitive device.

RF Micro Devices believes the furnished information is correct and accurate at the time of this printing. However, RF Micro Devices reserves the right to make changes to its products without notice. RF Micro Devices does not assume responsibility for the use of the described product(s).

Parameter	Specification			Unit	Condition
	Min.	Typ.	Max.		
Operating Range					
Overall Frequency Range	800 1800		1000 2000	MHz MHz	Low Band Operation High Band Operation
Supply Voltage (V _{CC})	2.7	2.8	3.0	V	VCC1 HB, VCC2 HB, VCC1 LB
Power Down Voltage (V _{BIAS})	2.7	2.8	3.0	V	HB BIAS, LB BIAS
Logic Control Voltage Level	0		3.0	V	HB SELECT, LB SELECT
Operating Ambient Temperature	-40		+85	°C	
Input Impedance		50		Ω	
Output Impedance		50		Ω	
950MHz Performance - High Gain Mode					T = 25°C, RF = 950MHz, VCC1LB = VCC2LB = 2.78V, LBSelect = 0V, Z _{IN} = Z _O = 50Ω
Gain	14	15.5	17	dB	
Gain Variation Over Temperature Range			±0.5	dB	
Gain Variation Over Frequency Band			±0.5	dB	
Noise Figure		1.1	2.0	dB	
Reverse Isolation	15	21		dB	
Input IP3	+2.0	+5.0		dBm	
Input P1dB	-12	-9		dB	
Input VSWR			2:1		
Output VSWR			2:1		
Total Current Draw		4.8	6.0	mA	900MHz LNA ENABLED, 1900MHz LNA DISABLED. I _{CC} + I _{PD}
950MHz Performance - Bypass Mode					T = 25°C, RF = 950MHz, VCC1LB = VCC2LB = 2.78V, LBSelect = 2.7V, Z _{IN} = Z _O = 50Ω
Gain	-8	-6	-3	dB	
Gain Reduction		21.5		dBc	
Input IP3	12.0	15.0		dBm	
Input P1dB	-1	+2		dB	
Input VSWR			2.5:1		
Output VSWR			2:1		
Total Current Draw					See Application Notes

Parameter	Specification			Unit	Condition
	Min.	Typ.	Max.		
1850MHz Performance - High Gain Mode					
Gain	15	17.5	19	dB	T = 25°C, RF = 1850MHz, VCC1HB = 2.78V, HBSelect = 0V, Z _{IN} = Z _O = 50Ω 1900MHz LNA ENABLED, 900MHz LNA DISABLED. I _{CC} + I _{PD}
Gain Variation Over Temperature Range			±0.5	dB	
Gain Variation Over Frequency Band			±0.5	dB	
Noise Figure		1.5	2.1	dB	
Reverse Isolation	15	20		dB	
Input IP3	-2.0	+1.0		dBm	
Input P1dB	-13	-10		dB	
Input VSWR			2:1		
Output VSWR			2:1		
Total Current Draw		8.2	10	mA	
1850MHz Performance - Bypass Mode					
Gain	-7	-5	-3	dB	T = 25°C, RF = 1850MHz, VCC1HB = 2.78V, HBSelect = 2.7V, Z _{IN} = Z _O = 50Ω
Gain Reduction	22	23	24	dBc	
Input IP3	12.0	15.0		dBm	
Input P1dB	+5	+8		dB	
Input VSWR			2:1		
Output VSWR			2.5:1		
Total Current Draw					See Applications Notes
AGC Settling Time			10	μs	
Rise and Fall Time			10	μs	

Pin	Function	Description	Interface Schematic
1	HB IN	DCS1800/PCS1900 RF input pin.	
2	HB BIAS	HB BIAS is set to the supply voltage at high gain mode. For bypass mode see "Gain Select Possibility".	
3	LB BIAS	LB BIAS is set to the supply voltage at high gain mode. For bypass mode see "Gain Select Possibility".	
4	LB IN	GSM900 RF input pin.	
5	LB GND	LNA emittance inductance. Total inductance is comprised of package+bondwire+L2 on PCB.	
6	LB OUT	GSM900 Amplifier Output pin. This pin is an open-collector output. It must be biased to V_{CC} through a choke or matching inductor. This pin is typically matched to 50Ω with a shunt bias/matching inductor and series blocking/matching capacitor. Refer to application schematics.	
7	LB SELECT	This pin selects high gain and bypass for GSM900. Select $\leq 0.8V$, high gain. Select $\geq 1.8V$, low gain.	
8	HB SELECT	This pin selects high gain and bypass for DCS1800/PCS1900. Select $\leq 0.8V$, high gain. Select $\geq 1.8V$, low gain.	
9	HB OUT	DCS1800 Amplifier Output pin. This pin is an open-collector output. It must be biased to V_{CC} through a choke or matching inductor. This pin is typically matched to 50Ω with a shunt bias/matching inductor and series blocking/matching capacitor. Refer to application schematics.	

Pin	Function	Description	Interface Schematic
10	HB GND2	LNA2 emittance inductance. Total inductance is comprised of package+bondwire+L5 on PCB.	
11	VCC1 HB	Open collector for first stage LNA of DCS1800/PCS1900. It must be biased to V_{CC} through a choke or matching inductor.	
12	HB GND1	LNA1 emittance inductance. Total inductance is comprised of package+bondwire+L7 on PCB.	

Application Notes

Bypass Mode Configurations

The RF2416 may be placed into either high gain or bypass mode via the HB SELECT and LB SELECT pins for high band and low band operation, respectively. The high gain state is selected by asserting the select pin for the appropriate band to a voltage level of less than 0.8V. For Bypass operation, there are two possible methods for placing the RF2416 into this low gain state. The table below shows the two possible Bypass states for each mode.

RF2416 Bypass Mode Possibilities

Gain Select (HB Mode)	HB BIAS (V)	VCC1_HB and VCC2_HB (V)	Current (mA)
2.7	0	2.78	1.4
2.7	2.7	2.78	1.9
Gain Select (LB Mode)	LB BIAS (V)	VCC1_LB (V)	Current (mA)
2.7	0	2.78	0.8
2.7	2.7	2.78	1.5

For both Bypass configurations, the select pin for the appropriate band must be placed at a level greater than or equal to 1.8V. The difference between the Bypass possibilities is determined by the specific application's ability to change the voltage of the bias pins independently of V_{CC} . The advantage of the ability to assert the bias pins to 0V when in Bypass mode is shown by the decreased current draw when in this Bypass configuration.

Evaluation Board Schematic
(Download [Bill of Materials](http://www.rfmd.com) from www.rfmd.com.)

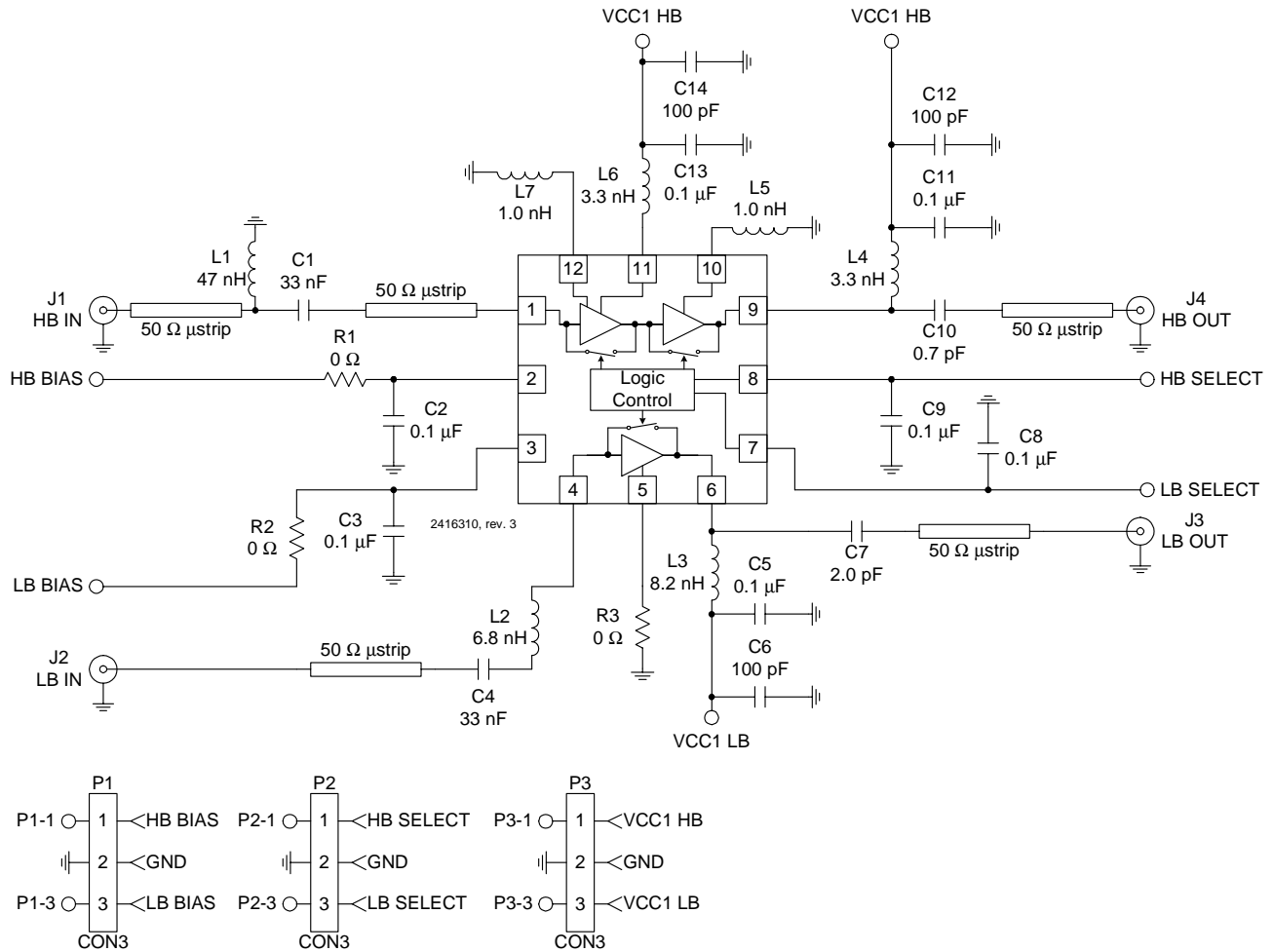

Evaluation Board Layout Board Size 2" x 2"

Board Thickness 0.060", Board Material FR-4, Multi-Layer

4

GENERAL PURPOSE
AMPLIFIERS

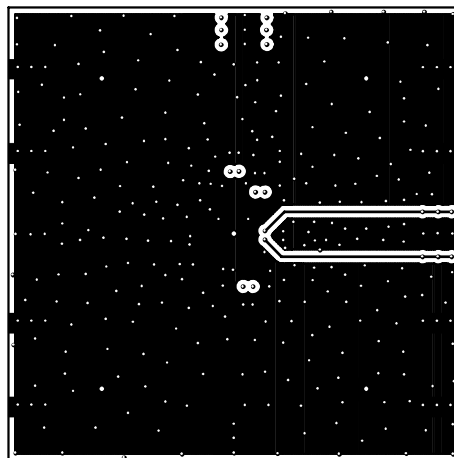
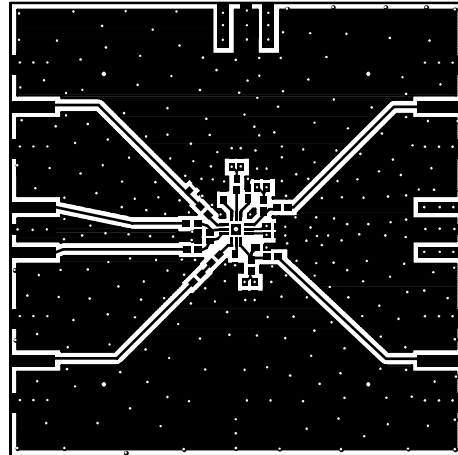
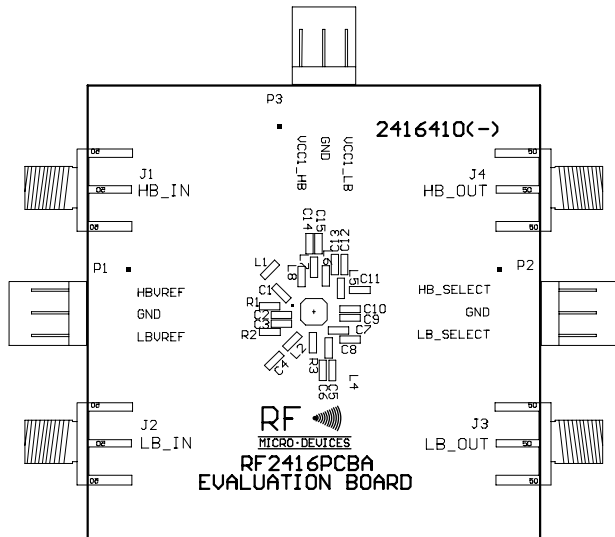

Low Band Bypass Mode (S11)

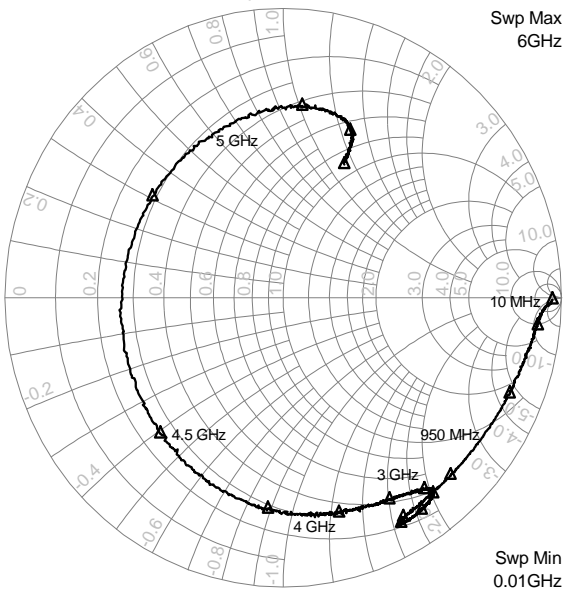

Low Band Bypass Mode (S22)

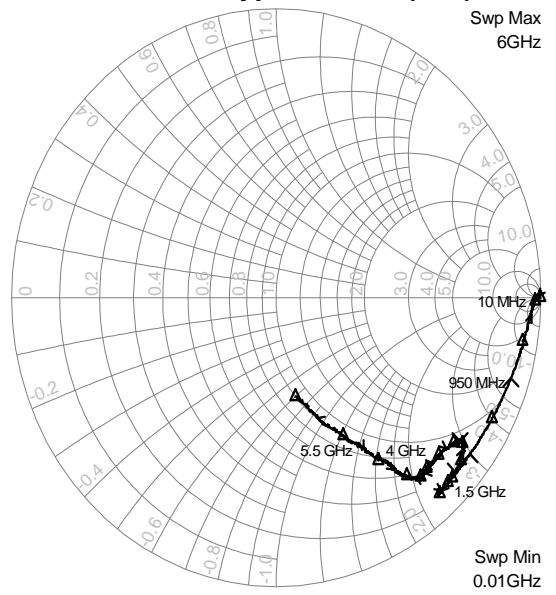

Low Band High Gain Mode (S11)

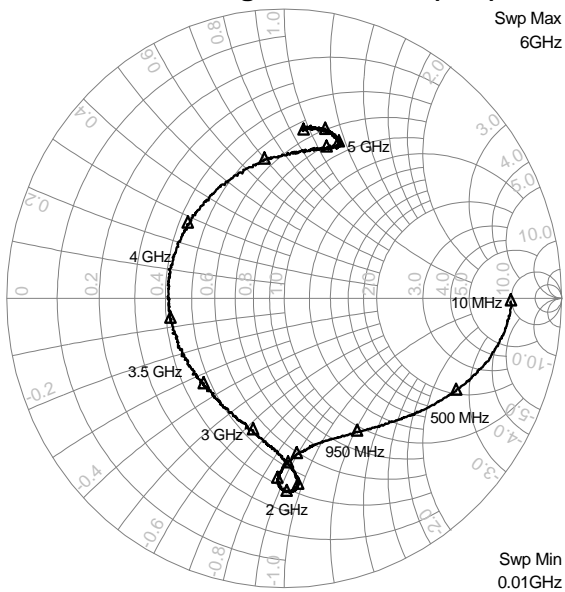

Low Band High Gain Mode (S22)

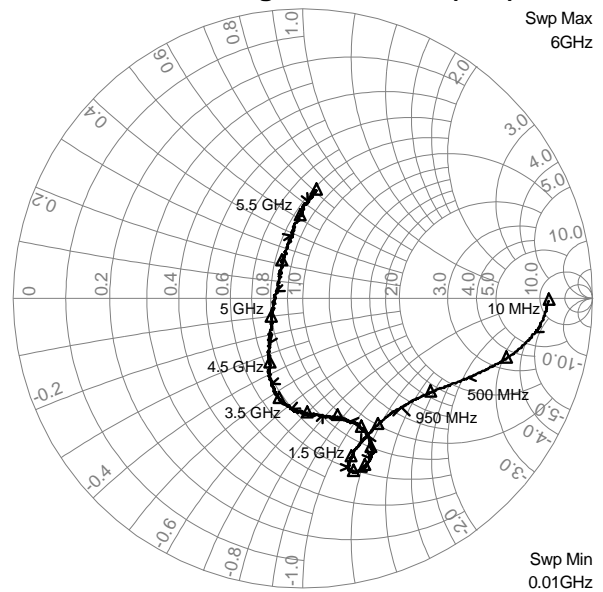

4
GENERAL PURPOSE
AMPLIFIERS

High Band Bypass Mode (S11)

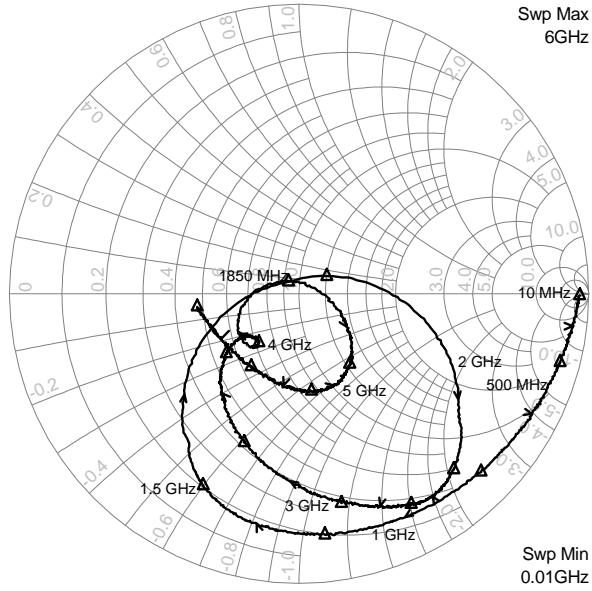

High Band Bypass Mode (S22)

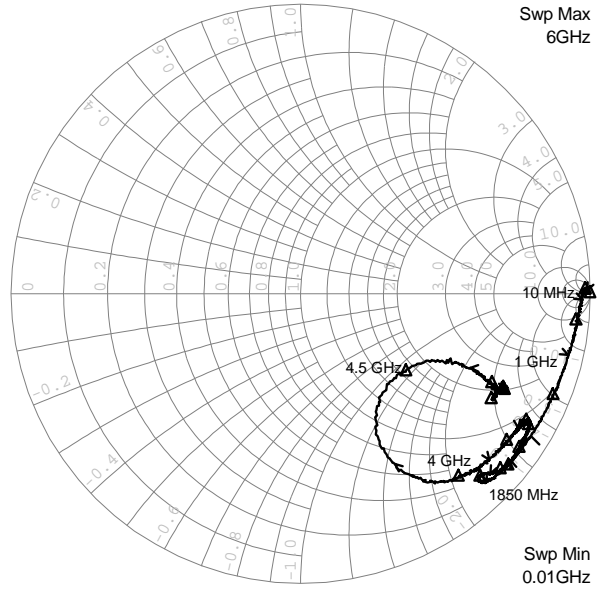

High Band High Gain Mode (S11)

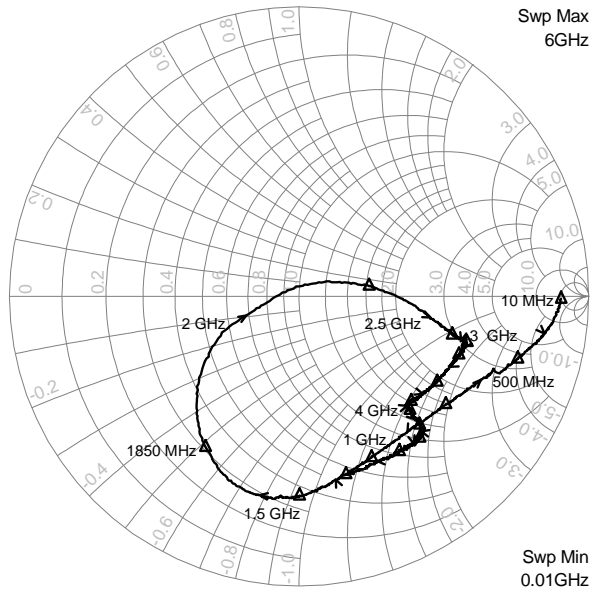

High Band High Gain Mode (S22)

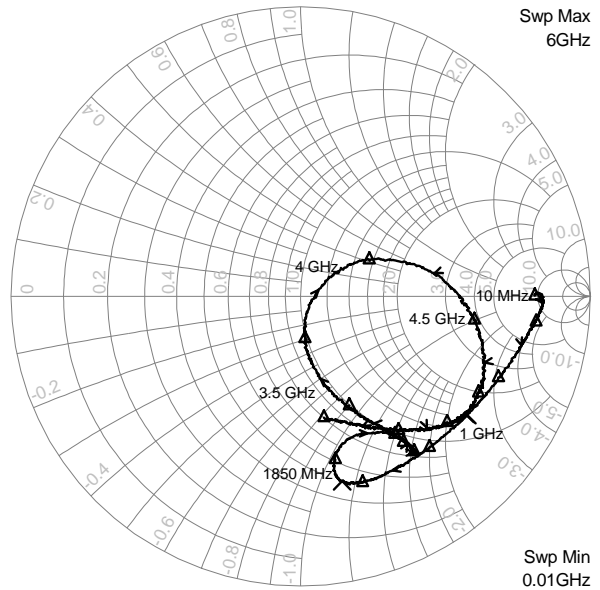

S-Parameter Conditions:

All plots shown were taken at VCC=2.78V and Ambient Temperature=25°C.

Note:

All S11 and S22 plots shown were taken from an RF2416 while on a 2416310 evaluation board. The data was captured without the external input or output tuning components in place, and the reference point at the HB IN and HB OUT pins for high band and LB IN and LB OUT for low band.