

MITSUBISHI DIODE MODULES
RM500DZ/UZ-M,-H,-24,-2H

HIGH POWER GENERAL USE
 INSULATED TYPE

RM500DZ/UZ-M,-H,-24,-2H



(DZ Type)

- **IF(AV)** Average forward current **800A**
- **VRRM** Repetitive peak reverse voltage
 **400/800/1200/1600V**
- **DOUBLE ARMS**
- **Insulated Type**

APPLICATION

AC motor controllers, DC motor controllers, Battery DC power supplies,
 DC power supplies for control panels, and other general DC power equipment

OUTLINE DRAWING & CIRCUIT DIAGRAM

Dimensions in mm

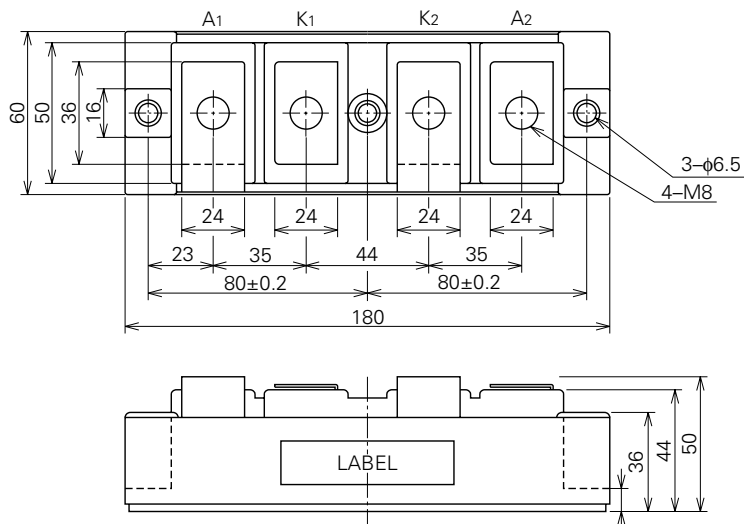

(DZ Type)

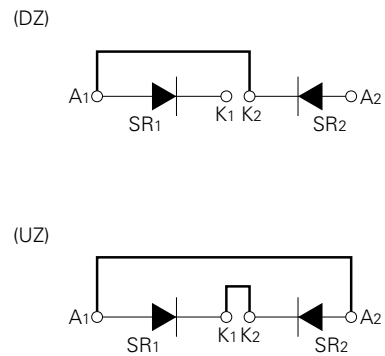

(Bold line is connective bar.)

RM500DZ/UZ-M,-H,-24,-2H

HIGH POWER GENERAL USE
INSULATED TYPE

ABSOLUTE MAXIMUM RATINGS

Symbol	Parameter	Voltage class				Unit
		M	H	24	2H	
VRRM	Repetitive peak reverse voltage	400	800	1200	1600	V
VRSM	Non-repetitive peak reverse voltage	480	960	1350	1700	V
VR (DC)	Reverse DC voltage	320	640	960	1280	V

Symbol	Parameter	Conditions	Ratings	Unit
IF (RMS)	RMS forward current		785	A
IF (AV)	Average forward current	Single-phase, half-wave 180° conduction, Tc=90°C	500	A
IFSM	Surge (non-repetitive) forward current	One half cycle at 60Hz, peak value	10000	A
I ² t	I ² t for fusing	Value for one cycle of surge current	4.2 × 10 ⁵	A ² s
f	Maximum operating frequency		1000	Hz
T _j	Junction temperature		-40~+150	°C
T _{stg}	Storage temperature		-40~+125	°C
V _{iso}	Isolation voltage	Charged part to case	2500	V
—	Mounting torque	Main terminal screw M8	8.83~10.8	N·m
			90~110	kg·cm
		Mounting screw M6	1.97~3.92	N·m
—	Weight	Typical value	20~40	kg·cm
			1100	g

ELECTRICAL CHARACTERISTICS

Symbol	Parameter	Test conditions	Limits			Unit
			Min.	Typ.	Max.	
I _{RRM}	Repetitive reverse current	T _j =150°C, V _{RRM} applied	—	—	40	mA
V _{FM}	Forward voltage	T _j =25°C, I _{FM} =1500A, instantaneous meas.	—	—	1.25	V
R _{th (j-c)}	Thermal resistance	Junction to case (per 1/2 module)	—	—	0.1	°C/W
R _{th (c-f)}	Contact thermal resistance	Case to fin, conductive grease applied (per 1/2 module)	—	—	0.08	°C/W
—	Insulation resistance	Measured with a 500V megohmmeter between main terminal and case	10	—	—	MΩ

RM500DZ/UZ-M,-H,-24.-2H

HIGH POWER GENERAL USE
INSULATED TYPE

PERFORMANCE CURVES

MAXIMUM FORWARD CHARACTERISTIC

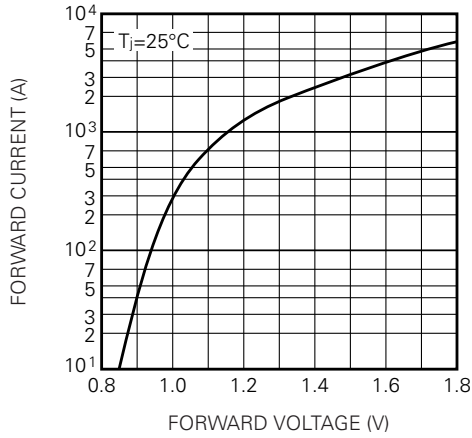

ALLOWABLE SURGE (NON-REPETITIVE) FORWARD CURRENT

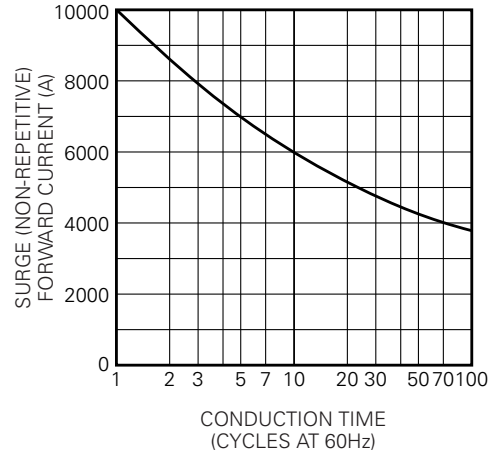

MAXIMUM TRANSIENT THERMAL IMPEDANCE (JUNCTION TO CASE)

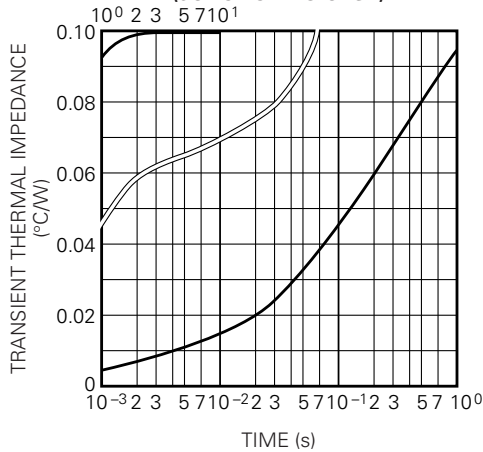

MAXIMUM POWER DISSIPATION

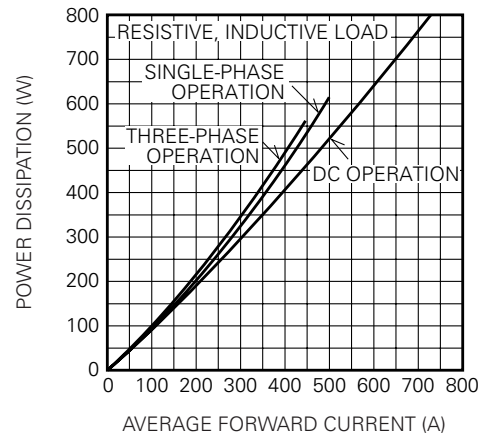

ALLOWABLE CASE TEMPERATURE VS. AVERAGE FORWARD CURRENT

