

Hermetic, Dual-In-Line or TO Package Resistor Networks

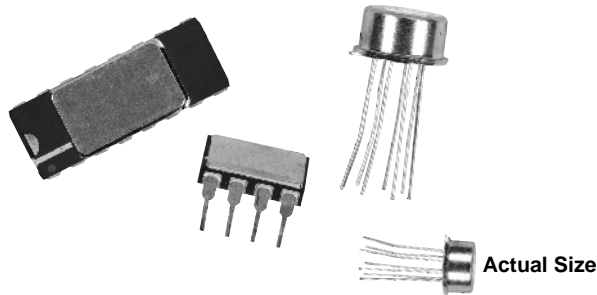

FEATURES

- High Stability: < 300ppm Max., 2000 hrs., Pn + 70°C
- Hermetic Cases: Dual-In-Line and TO99

TYPICAL PERFORMANCE

▲	ABS	TRACKING
	TCR	10
TOL	ABS	RATIO
	0.05	0.02

The superstable RMK nickel-chromium integrated networks are available in a range of standard designs which bring a completely new "state-of-the-art" to precision network performance criteria.

Circuit designers can now incorporate into their circuitry the ultimate in today's performance characteristics as "standards", without needing to call out specially engineered designs at premium prices.

SCHEMATIC Standard Configuration, Hermetic Case TO99

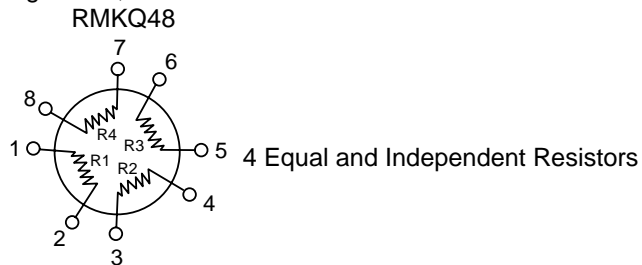

THROUGH HOLE

Standard Configuration, 8 Leads Hermetic DIL RMKD 408

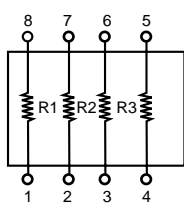

4 Equal and Independent Resistors

RMKD 508

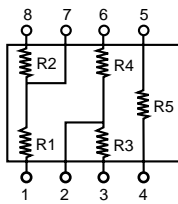

Dual Divider Feedback Network with Equal Value Resistors

Standard Configuration, 16 Leads Hermetic DIL RMKD86

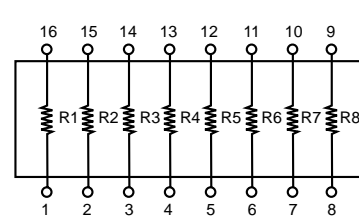

8 Equal and Independent Resistors

Standard Configuration, 14 Leads Hermetic DIL

RMKD714

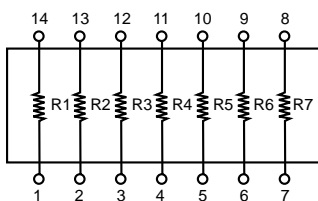

7 Equal and Independent Resistors

RMKD914

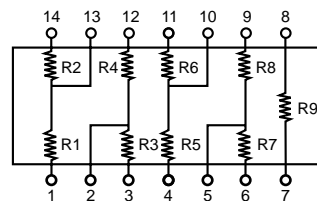

Quad Divider Feedback Network with Equal Value Resistors



STANDARD ELECTRICAL SPECIFICATIONS			
TEST	SPECIFICATIONS		CONDITIONS
CONFIGURATION	RMK Q48, RMK D408, RMK D508, RMK D714, RMK D816, RMK D914		
Resistance Range	500Ω < R < 200KΩ		
TCR:	Tracking	± 1ppm/°C Typical ± 2ppm/°C Max.	- 55°C to + 125°C
	Absolute	± 5ppm/°C typical	0°C to + 70°C
		± 10ppm/°C Max.	- 55°C to + 125°C
Tolerance	Ratio	± 0.05% ± 0.02% ± 0.01%	
	Absolute	± 0.1% ± 0.05% ± 0.05%	
Power Rating:	Package	125mW 250mW 250mW 250mW 250mW 250mW	@ + 70°C
Stability (ΔR Ratio)	< 300ppm Max.		2000 hrs., at + 70°C
Working Voltage	100Vcc on R		
Operating Temperature Range	- 55°C to + 125°C		
Storage Temperature Range	- 55°C to + 155°C		
Noise	- 35dB typical		MIL-STD-202, Md. 308
Thermal EMF	< 0.1μV/°C		

RMKQ 48

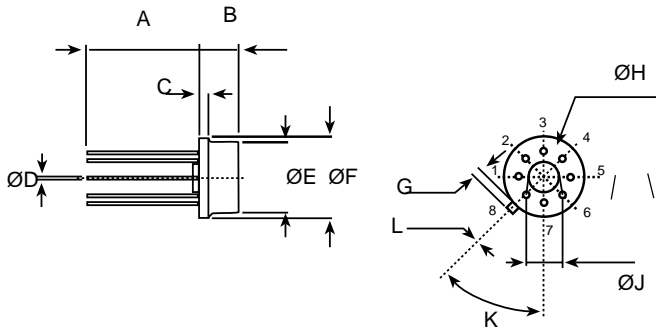

DIMENSIONS in inches and millimeters

DIMENSION	INCHES		MILLIMETERS	
	Min.	Max.	Min.	Max.
A	0.500	—	12.70	—
B	0.164	0.194	4.19	4.95
C	—	0.040	—	1.02
ØD	0.016	0.019	0.41	0.48
ØE	0.315	0.335	8.00	8.51
ØF	0.346	0.370	8.89	9.40
G	0.029	0.043	0.74	1.14
ØH	—	0.229	—	5.84
ØJ	0.137	0.159	3.05	4.06
K	45°		45°	
L	0.027	0.033	0.71	0.86

RMKQ 408 and RMKD 508

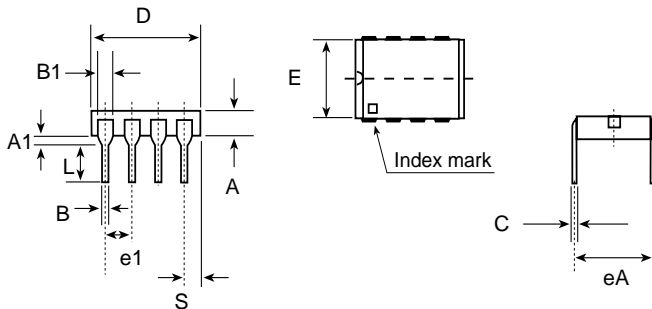

DIMENSIONS in inches and millimeters

DIMENSION	INCHES	MILLIMETERS
D	0.401	10.2 ± 0.10
B1	0.046	1.19
A1	0.035	0.89 ± 0.25
A	0.086	2.2 ± 0.20
L	0.129 Min.	3.3 Min.
B	0.018	0.46 ± 0.05
e1	0.100	2.54 ± 0.10
S	0.050	1.27 ± 0.50
E	0.290	7.37 ± 0.20
C	0.009	0.25 ± 0.05
eA	0.300	7.62 ± 0.20

VISHAY THIN FILM • FRANCE +33.4.93.37.28.24 FAX: +33.4.93.37.27.31 • GERMANY +49.9287.710 FAX: +49 9287.70435 • ISRAEL +972.3.557.0945 FAX: +972.3.558.9121
 • ITALY + 39.2.300.11919 FAX: +39.2.300.11999 • JAPAN +81.42.729.0661 FAX: +81.42.729.3400 • SINGAPORE +65.788.6668 FAX: +65.788.0988
 • SWEDEN +46.8.594.70590 FAX: +46.8.594.70581 • UK +44 191 514 8237 FAX: +44 1953 457 722 • USA: (610) 407-4800 FAX: (610) 640-9081

THROUGH HOLE

RMKD, RMKQ 48

Vishay Thin Film Hermetic, Dual-In-Line or TO Package Resistor Networks



RMKD 714 and RMKD 914

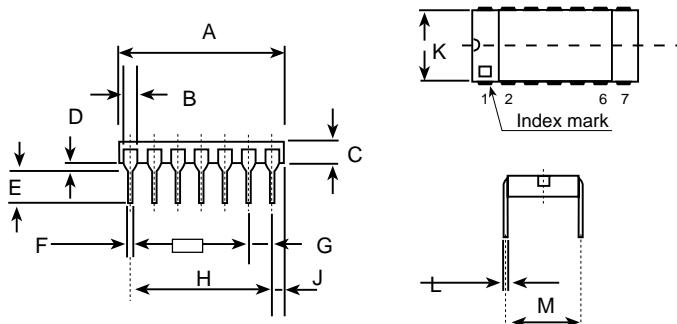

DIMENSIONS in inches and millimeters		
DIMENSION	INCHES	MILLIMETERS
A	0.700	17.78 ± 0.20
B	0.046	1.19
C	0.086	2.20 ± 0.20
D	0.035	0.89 ± 0.25
E	0.129	3.30
F	0.018	0.46 ± 0.05
G	0.100	2.54 ± 0.10
H	0.600	15.24 ± 0.10
J	0.050	1.27 ± 0.50
K	0.290	7.37 ± 0.20
L	0.009	0.25 ± 0.05
M	0.300	7.62 ± 0.20

RMKD 816

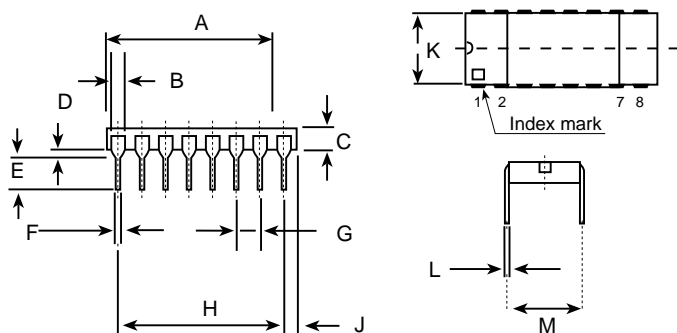

DIMENSIONS in inches and millimeters		
DIMENSION	INCHES	MILLIMETERS
A	0.799	20.30 ± 0.20
B	0.046	1.19
C	0.092	2.35 ± 0.20
D	0.035	0.89 ± 0.25
E	0.129	3.3
F	0.018	0.46 ± 0.05
G	0.011	2.54 ± 0.1
H	0.7	17.78 ± 0.1
J	0.05	1.27 ± 0.5
K	0.29	7.37 ± 0.2
L	0.009	0.25 ± 0.05
M	0.3	7.62 ± 0.2

THROUGH HOLE

MECHANICAL SPECIFICATIONS

Resistive Material	Nichrome
Passivation	Mineral Passivation Si ₃ N ₄

How to Order

Series	Style	Number of Resistors	Number of Pins	Ohmic Value	Absolute Tolerance	Tolerance Ratio
RMK	D	7	14	100K Ω	±0.05%	0.02%

Q = Quad
D = Dual

Custom packages available; please consult factory for additional configurations.

VISHAY THIN FILM • FRANCE +33.4.93.37.28.24 FAX: +33.4.93.37.27.31 • GERMANY +49.9287.710 FAX: +49.9287.70435 • ISRAEL +972.3.557.0945 FAX: +972.3.558.9121
• ITALY + 39.2.300.11919 FAX: +39.2.300.11999 • JAPAN +81.42.729.0661 FAX: +81.42.729.3400 • SINGAPORE +65.788.6668 FAX: +65.788.0988
• SWEDEN +46.8.594.70590 FAX: +46.8.594.70581 • UK +44 191 514 8237 FAX: +44 1953 457 722 • USA: (610) 407-4800 FAX: (610) 640-9081