

TOSHIBA Transistor Silicon PNP Epitaxial Type (PCT Process)

RN2221,RN2222,RN2223 RN2224,RN2225,RN2226,RN2227

Switching, Inverter Circuit, Interface Circuit
And Driver Circuit Applications

Unit: mm

- High current type ($I_C(\text{MAX}) = -800\text{mA}$)
- With built-in bias resistors
- Simplify circuit design
- Reduce a quantity of parts and manufacturing process
- Low $V_{CE}(\text{sat})$
- Complementary to RN1221~RN1227

Equivalent Circuit

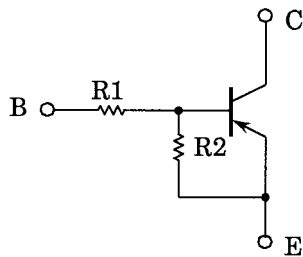

Bias Resistor Values

Type No.	R1 (kΩ)	R2 (kΩ)
RN2221	1	1
RN2222	2.2	2.2
RN2223	4.7	4.7
RN2224	10	10
RN2225	0.47	10
RN2226	1	10
RN2227	2.2	10

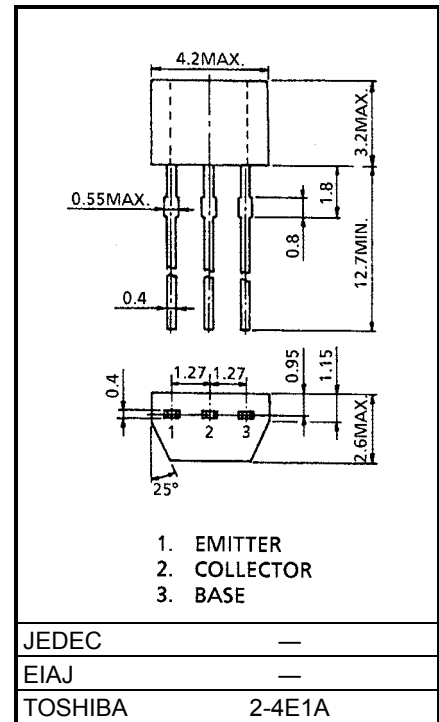

JEDEC	—
EIAJ	—
TOSHIBA	2-4E1A

Weight: 0.13g

Maximum Ratings ($T_a = 25^\circ\text{C}$)

Characteristic	Symbol	Rating	Unit	
Collector-base voltage	RN2221~2227	V_{CB0}	-50	V
Collector-emitter voltage		V_{CEO}	-50	V
Emitter-base voltage	RN2221~2224	V_{EBO}	-10	V
	RN2225, 2226		-5	
	RN2227		-6	
Collector current	RN2221~2227	I_C	-800	mA
Collector power dissipation		P_C	300	mW
Junction temperature		T_j	150	$^\circ\text{C}$
Storage temperature range		T_{stg}	-55~150	$^\circ\text{C}$

Electrical Characteristics (Ta = 25°C)

Characteristic		Symbol	Test Circuit	Test Condition	Min	Typ.	Max	Unit
Collector cut-off current	RN2221~2227	—	—	$V_{CB} = -50V, I_E = 0$	—	—	-100	nA
		—	—	$V_{CE} = -50V, I_B = 0$	—	—	-500	
Emitter cut-off current	RN2221	I_{EBO}	—	$V_{EB} = -10V, I_E = 0$	-3.85	—	-7.14	mA
	RN2222		—		-1.75	—	-3.25	
	RN2223		—		-0.82	—	-1.52	
	RN2224		—	$V_{EB} = -5V, I_C = 0$	-0.38	—	-0.71	
	RN2225		—		-0.365	—	-0.682	
	RN2226		—		-0.35	—	-0.65	
	RN2227		—		$V_{EB} = -6V, I_C = 0$	-0.378	—	
DC current gain	RN2221	h_{FE}	—	$V_{CE} = -1V, I_C = -100mA$	60	—	—	—
	RN2222		—		65	—	—	
	RN2223		—		70	—	—	
	RN2224		—		90	—	—	
	RN2225		—		90	—	—	
	RN2226		—		90	—	—	
	RN2227		—		90	—	—	
Collector-emitter saturation voltage	RN2221	$V_{CE(sat)}$	—	$I_C = -50mA, I_B = -2mA$	—	—	-0.25	V
	RN2222~2227		—	$I_C = -50mA, I_B = -1mA$				
Input voltage (ON)	RN2221	$V_{I(ON)}$	—	$V_{CE} = -0.2V, I_C = -100mA$	-1.0	—	-3.5	V
	RN2222		—		-1.4	—	-4.5	
	RN2223		—		-2.0	—	-6.5	
	RN2224		—		-3.0	—	-12.0	
	RN2225		—		-0.6	—	-2.0	
	RN2226		—		-0.7	—	-2.5	
	RN2227		—		-1.0	—	-3.0	
Input voltage (OFF)	RN2221~2224	$V_{I(OFF)}$	—	$V_{CE} = -5V, I_C = -0.1mA$	-0.8	—	-1.3	V
	RN2225, 2226		—		-0.4	—	-0.8	
	RN2227		—		-0.5	—	-1.0	
Transition frequency	RN2221~2227	f_T	—	$V_{CE} = -5V, I_C = -20mA$	—	200	—	MHz
Collector output capacitance	RN2221~2227	C_{ob}	—	$V_{CB} = -10V, I_E = 0, f = 1MHz$	—	13	—	pF
Input resistor	RN2221	R1	—	—	0.7	1.0	1.3	kΩ
	RN2222		—		1.54	2.2	2.86	
	RN2223		—		3.29	4.7	6.11	
	RN2224		—		7	10	13	
	RN2225		—		0.329	0.47	0.61	
	RN2226		—		0.7	1.0	1.3	
	RN2227		—		1.54	2.2	2.86	
Resistor ratio	RN2221~2224	R1/R2	—	—	0.9	1.0	1.1	—
	RN2225		—		0.0423	0.047	0.0517	
	RN2226		—		0.09	0.1	0.11	
	RN2227		—		0.2	0.22	0.24	

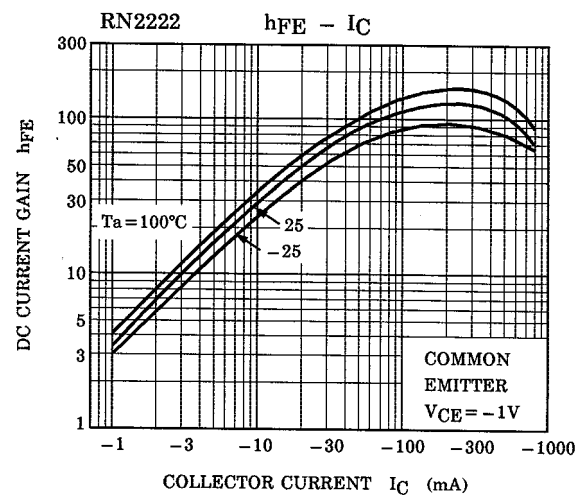
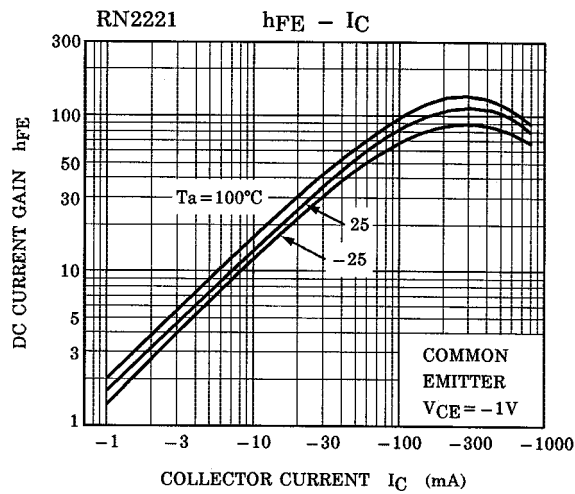
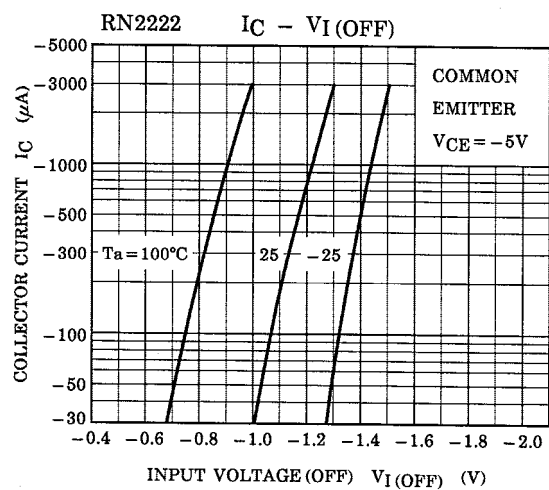
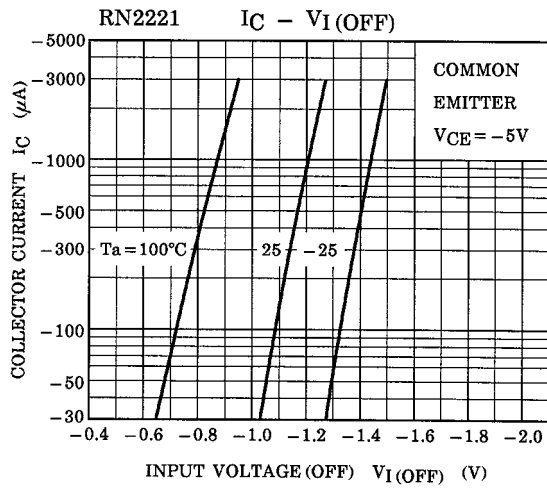
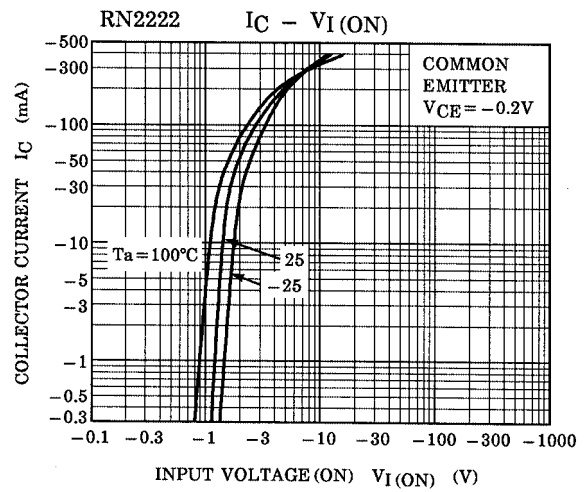
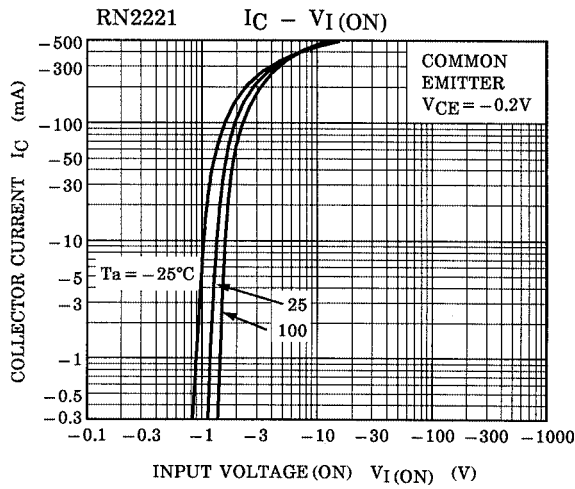

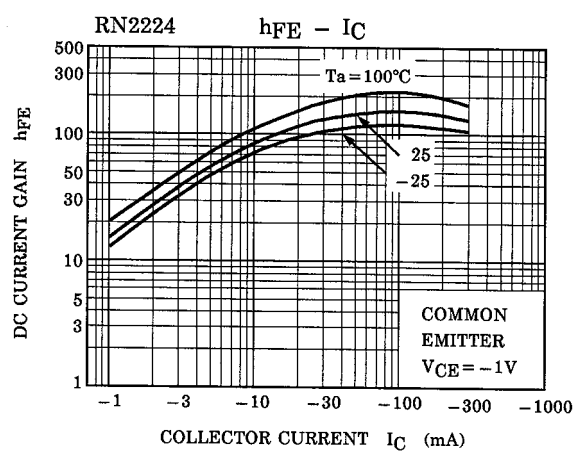
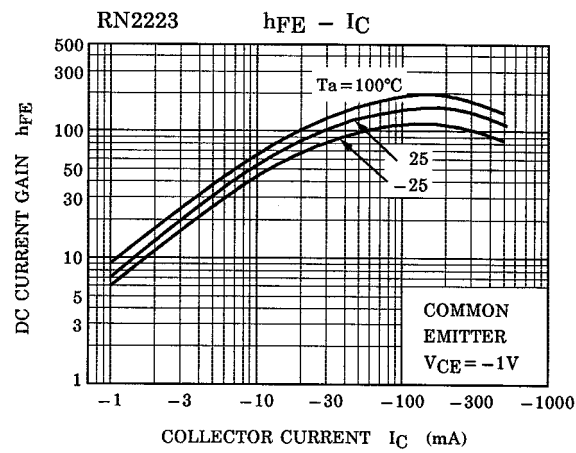
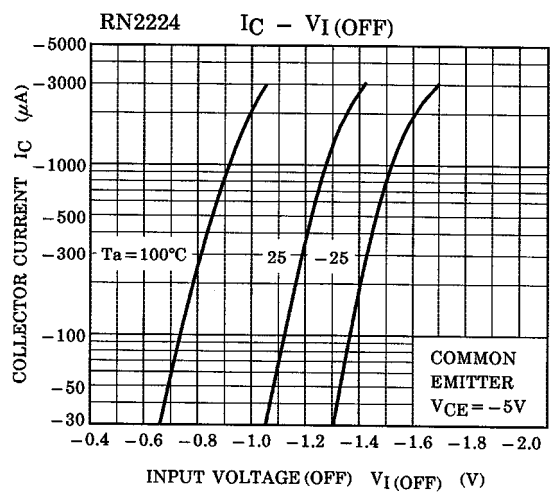
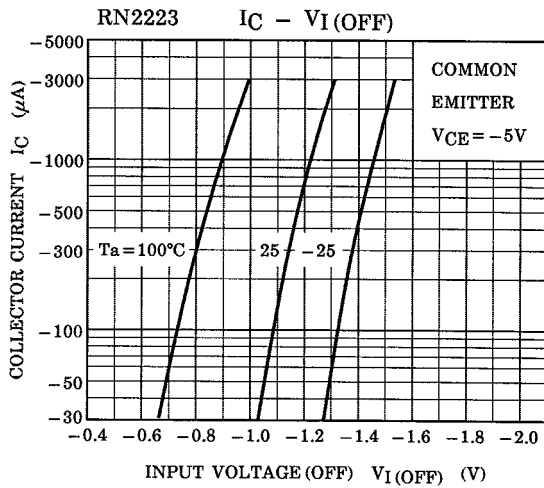
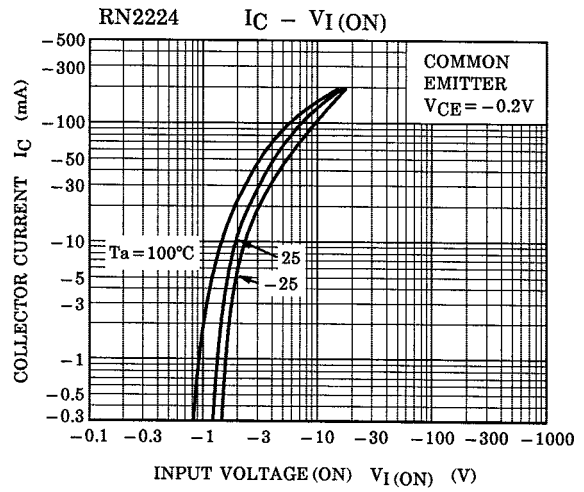
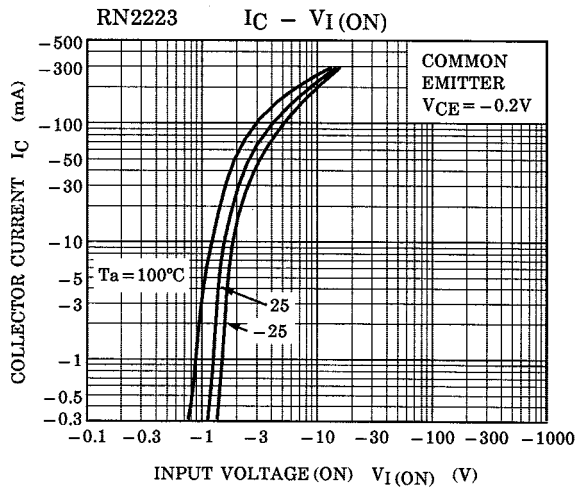

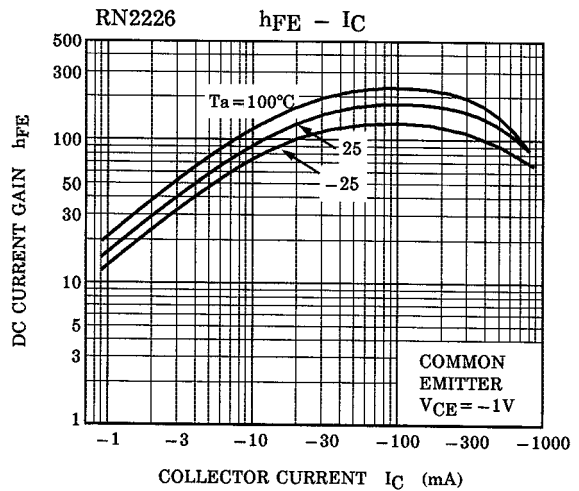
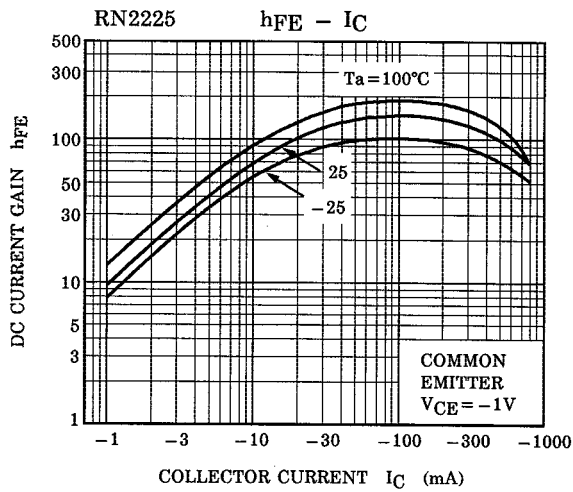
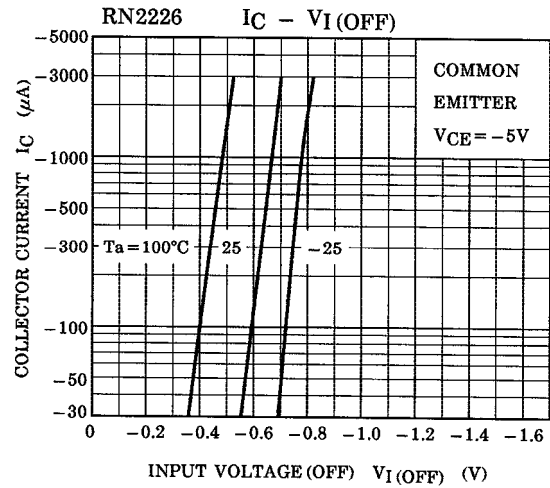
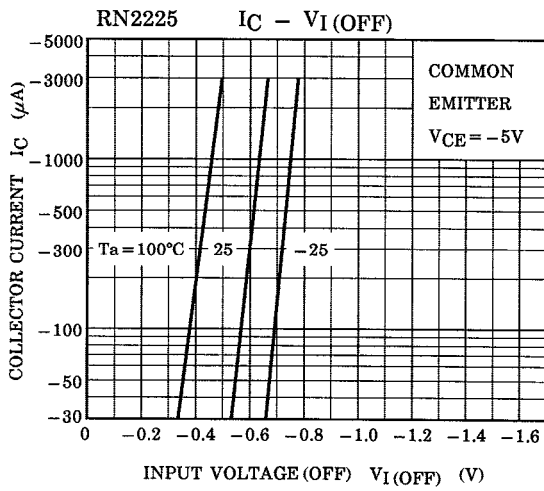
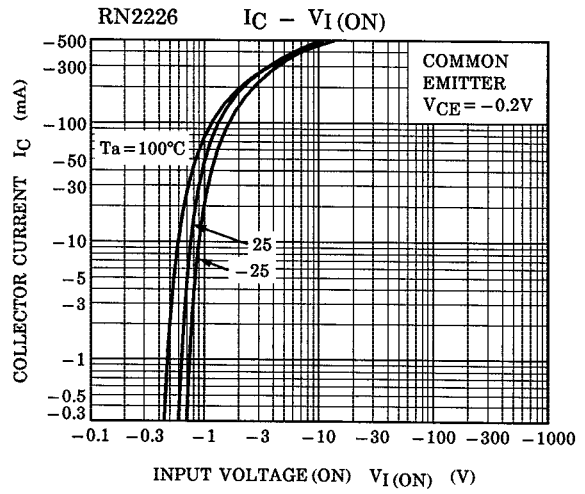
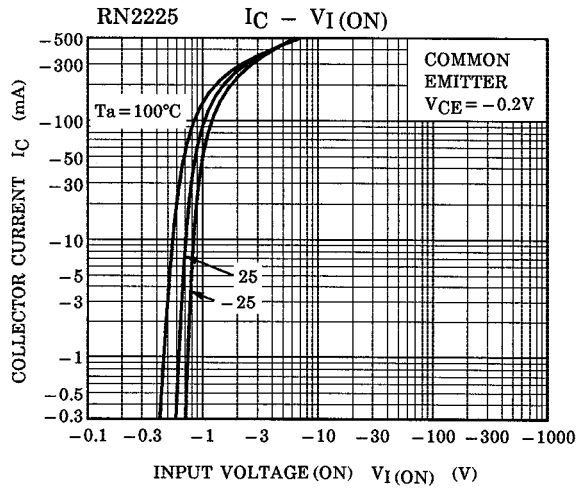

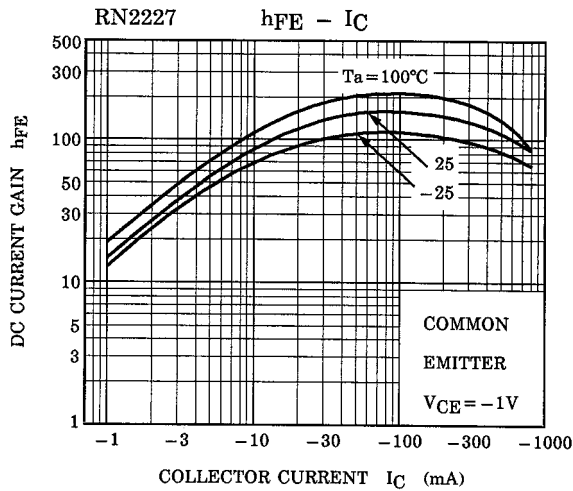
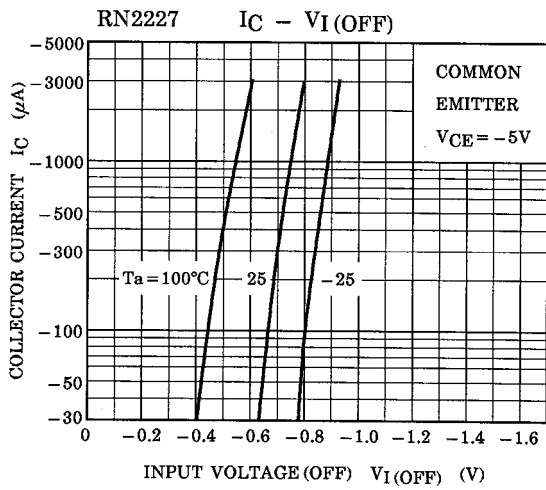
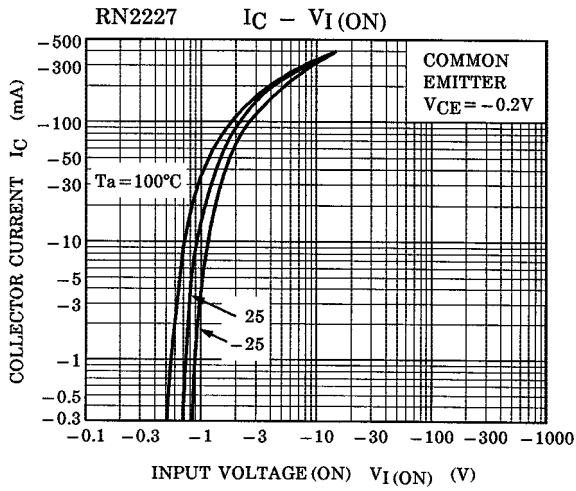

RESTRICTIONS ON PRODUCT USE

000707EAA

- TOSHIBA is continually working to improve the quality and reliability of its products. Nevertheless, semiconductor devices in general can malfunction or fail due to their inherent electrical sensitivity and vulnerability to physical stress. It is the responsibility of the buyer, when utilizing TOSHIBA products, to comply with the standards of safety in making a safe design for the entire system, and to avoid situations in which a malfunction or failure of such TOSHIBA products could cause loss of human life, bodily injury or damage to property.
In developing your designs, please ensure that TOSHIBA products are used within specified operating ranges as set forth in the most recent TOSHIBA products specifications. Also, please keep in mind the precautions and conditions set forth in the "Handling Guide for Semiconductor Devices," or "TOSHIBA Semiconductor Reliability Handbook" etc..
- The TOSHIBA products listed in this document are intended for usage in general electronics applications (computer, personal equipment, office equipment, measuring equipment, industrial robotics, domestic appliances, etc.). These TOSHIBA products are neither intended nor warranted for usage in equipment that requires extraordinarily high quality and/or reliability or a malfunction or failure of which may cause loss of human life or bodily injury ("Unintended Usage"). Unintended Usage include atomic energy control instruments, airplane or spaceship instruments, transportation instruments, traffic signal instruments, combustion control instruments, medical instruments, all types of safety devices, etc.. Unintended Usage of TOSHIBA products listed in this document shall be made at the customer's own risk.
- The information contained herein is presented only as a guide for the applications of our products. No responsibility is assumed by TOSHIBA CORPORATION for any infringements of intellectual property or other rights of the third parties which may result from its use. No license is granted by implication or otherwise under any intellectual property or other rights of TOSHIBA CORPORATION or others.
- The information contained herein is subject to change without notice.