

# Micro-Power Voltage Detectors

## General Description

The RT9808 is a micro-power voltage detector supervising the power supply voltage level for microprocessors ( $\mu P$ ) or digital systems. It provides internally fixed threshold levels with 0.1V per step ranging from 1.5V to 5V, which covers most digital applications. It features low supply current of  $3\mu A$ .

The RT9808 performs supervisory function by sending out a reset signal whenever the VDD voltage falls below a preset threshold level. This reset signal will last the whole period before VDD recovering. Once VDD recovered up-crossing the threshold level, the reset signal will be released if VDD is above threshold and last for the whole period of reset active time out.

RT9808 is n-channel, open-drain output.

## Applications

- Computers
- Controllers
- Intelligent Instruments
- Critical  $\mu P$  and  $\mu C$  Power Monitoring
- Portable/Battery-Powered Equipment

## Ordering Information

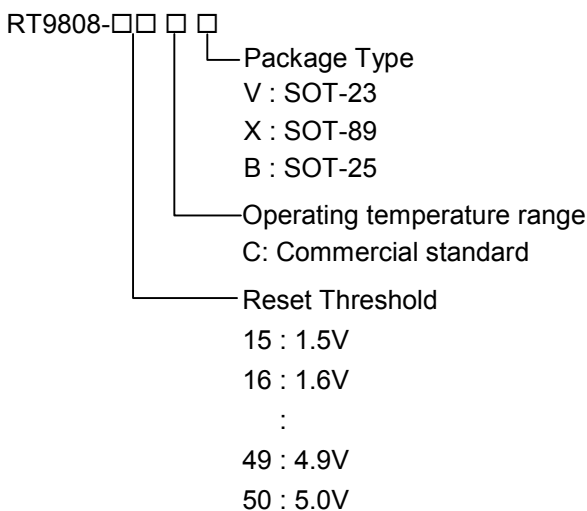

## Features

- Internally Fixed Threshold 1.5V to 5V in 0.1V Step
- $\pm 2\%$  Accuracy
- Low Supply Current  $3\mu A$
- Quick Reset within  $20\mu S$
- Built-in Recovery Delay 200mS
- Low Functional Supply Voltage 0.9V
- N-Channel Open Drain Output
- Small 3-Pin SOT-23/SOT89 and 5-Pin SOT-25 Packages

## Pin Configurations

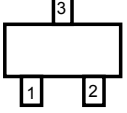
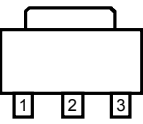
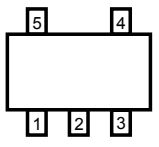
Part Number	Pin Configurations
RT9808-□□CV (Plastic SOT-23)	 <p>TOP VIEW</p> <ol style="list-style-type: none"> <li>1. <math>\overline{RESET}</math></li> <li>2. GND</li> <li>3. VDD</li> </ol>
RT9808-□□CX (Plastic SOT-89)	 <p>TOP VIEW</p> <ol style="list-style-type: none"> <li>1. <math>\overline{RESET}</math></li> <li>2. VDD</li> <li>3. GND</li> </ol>
RT9808-□□CB (Plastic SOT-25)	 <p>TOP VIEW</p> <ol style="list-style-type: none"> <li>1. <math>\overline{RESET}</math></li> <li>2. VDD</li> <li>3. GND</li> <li>4. NC</li> <li>5. NC</li> </ol>

## Typical Application Circuit

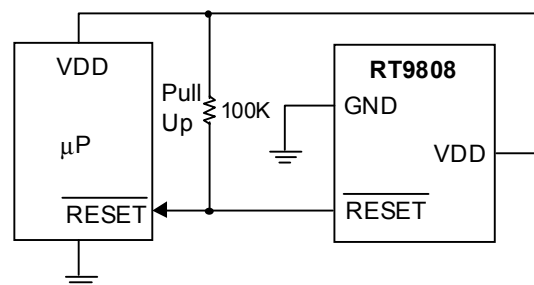

**Pin Description**

Pin Name	Pin Function
GND	Ground Pin
$\overline{\text{RESET}}$	Reset Pulse Output, Negative Pulse
VDD	Power Pin
NC	No Connected

**Function Block Diagram**

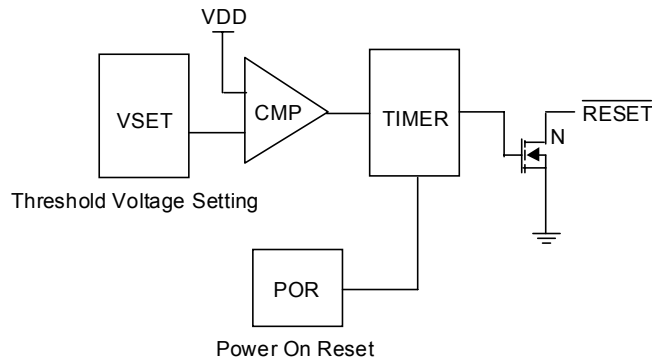

**Absolute Maximum Ratings**

- Terminal Voltage (with Respect to GND)
  - VDD ----- -0.3V to 6.0V
  - All Other Inputs ----- -0.3V to VDD+0.3V
- Input Current, VDD ----- 20mA
- Output Current,  $\overline{\text{RESET}}$  ----- 20mA
- Power Dissipation,  $P_D @ T_A = 25^\circ\text{C}$ 
  - SOT-23 ----- 0.25W
  - SOT-89 ----- 0.5W
  - SOT-25 ----- 0.25W
- Operating Junction Temperature Range -----  $-40^\circ\text{C} \sim 125^\circ\text{C}$
- Storage Temperature Range -----  $-65^\circ\text{C} \sim 125^\circ\text{C}$
- Package Thermal Resistance
  - SOT-23,  $\theta_{JA}$  -----  $250^\circ\text{C/W}$
  - SOT-89,  $\theta_{JC}$  -----  $100^\circ\text{C/W}$
  - SOT-89,  $\theta_{JA}$  -----  $300^\circ\text{C/W}$
  - SOT-25,  $\theta_{JA}$  -----  $250^\circ\text{C/W}$
- Lead Temperature (Soldering, 5sec.) -----  $260^\circ\text{C}$

**Electrical Characteristics**

(VDD = 3.0, unless specified)

Parameter	Symbol	Test Conditions	Min	Typ	Max	Units
Operating VDD ( $V_{OUT}$ ) Range	$V_{DD}$		0.9	--	6	V
Supply Current	$I_{DD}$	$V_{DD} = 1.5V \sim 5V, I_{OUT} = 0$	--	3	--	$\mu\text{A}$
Reset Threshold	$V_{TH}$	$T_A = 27^\circ\text{C}$	--	Note1	--	V
Threshold Voltage Accuracy	$\Delta V_{TH}$	$T_A = 27^\circ\text{C}$	--	--	2	%
VCC Drop to Reset Delay	$t_{RD}$	Drop = -125mV	--	--	20	$\mu\text{S}$
Reset Active Time Out Period	$t_{RP}$	$V_{DD} \geq 1.02 \times V_{TH}$	--	200	--	mS
$\overline{\text{RESET}}$ Output Voltage	$V_{OL}$	$V_{DD} < V_{TH}, I_{SINK} > 3.5\text{mA}$	--	0.4	--	V

Note1: 1.5V ~ 5V, step 0.1V

## Measuring Circuit

(1) Detection Voltage

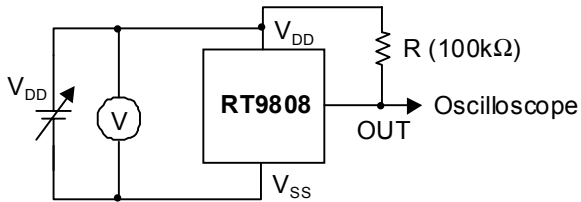

(3) Output Transistor Current

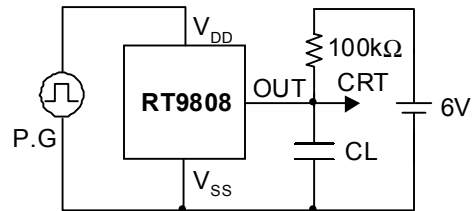

(2) Current Consumption

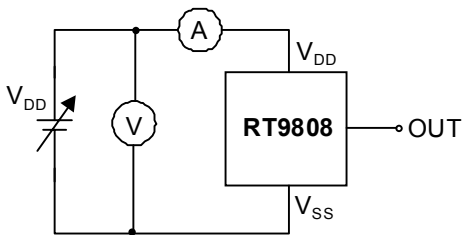

(4) Dynamic Response

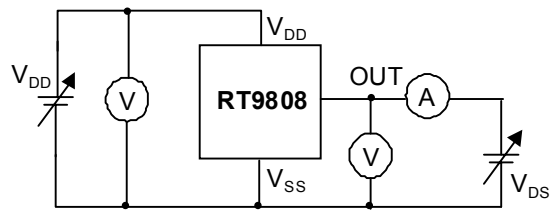

**Typical Operating Characteristics**

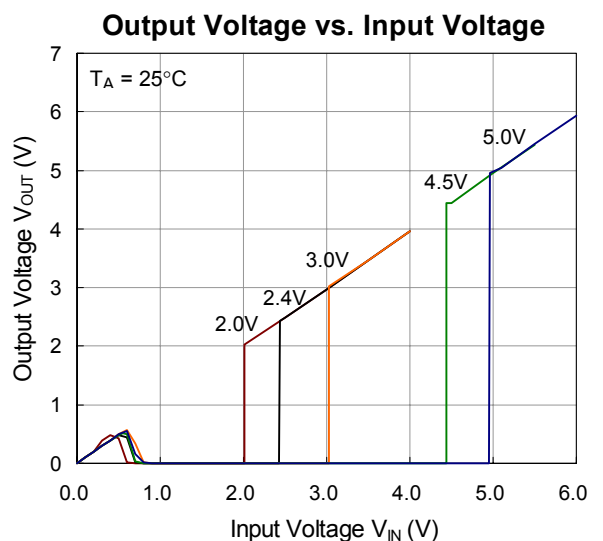
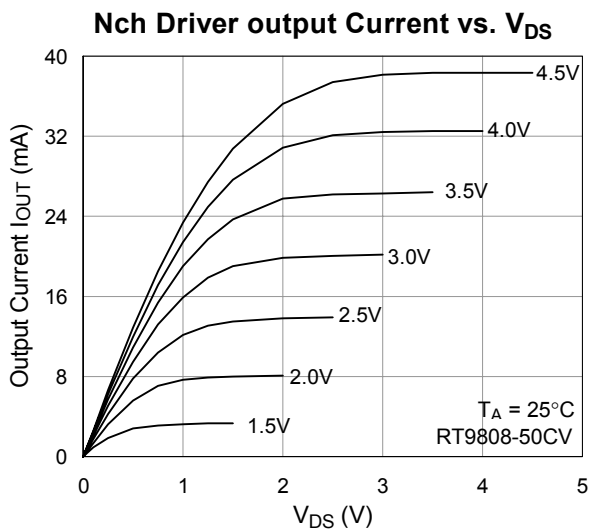
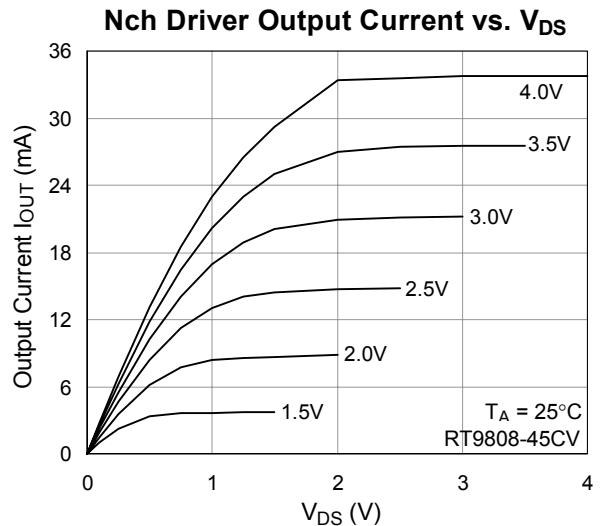
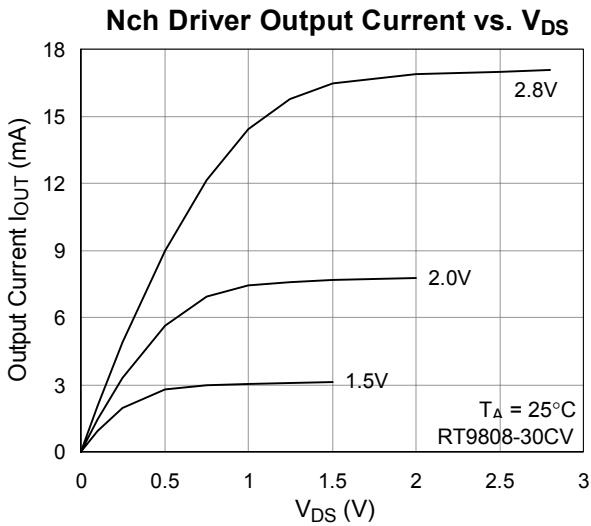
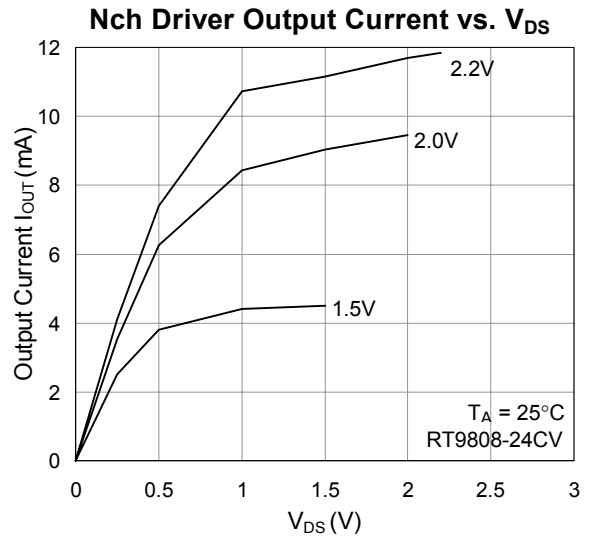
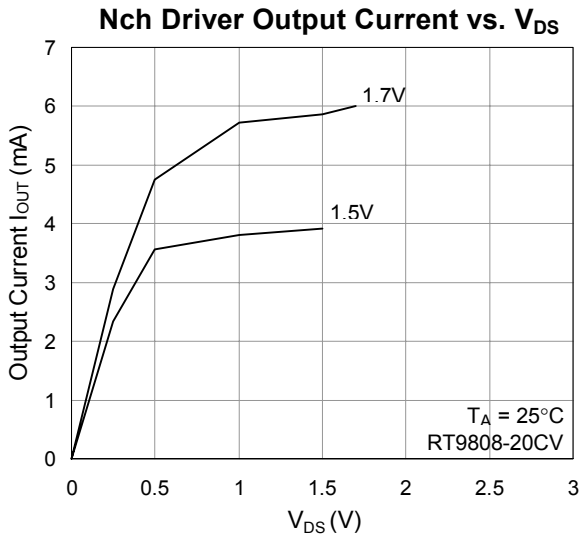

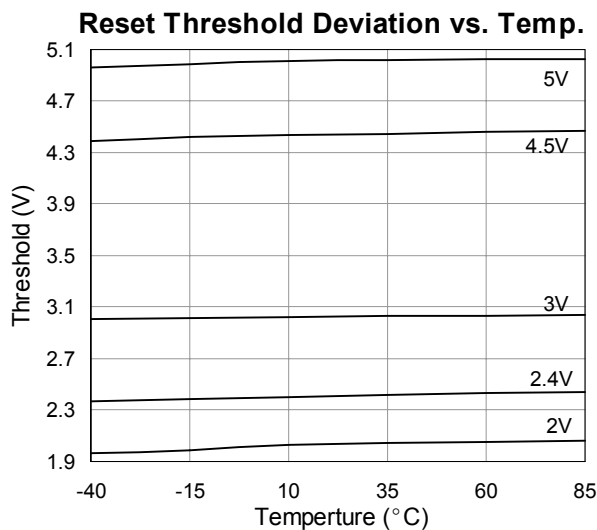
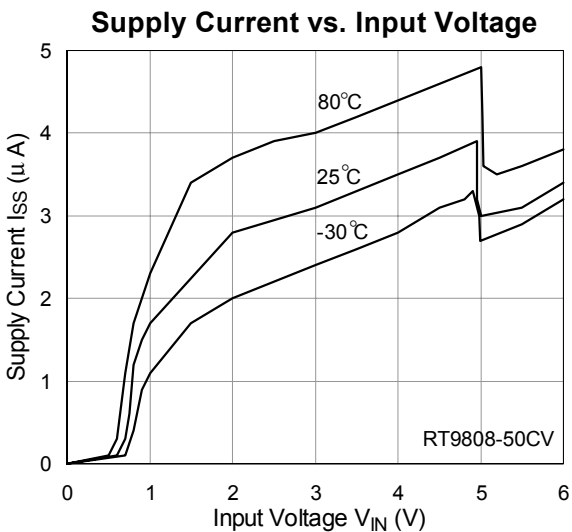
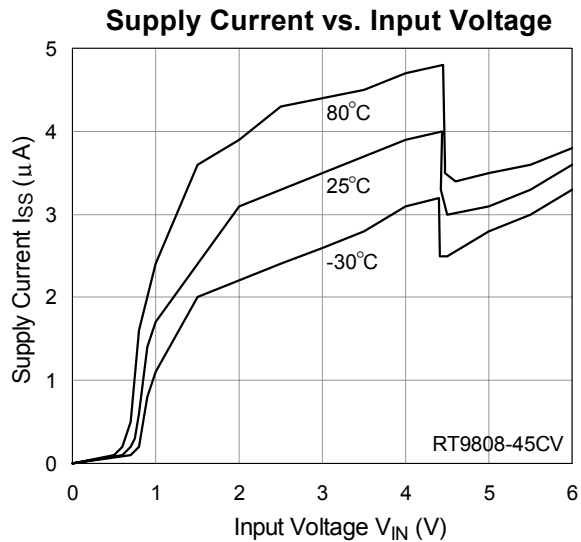
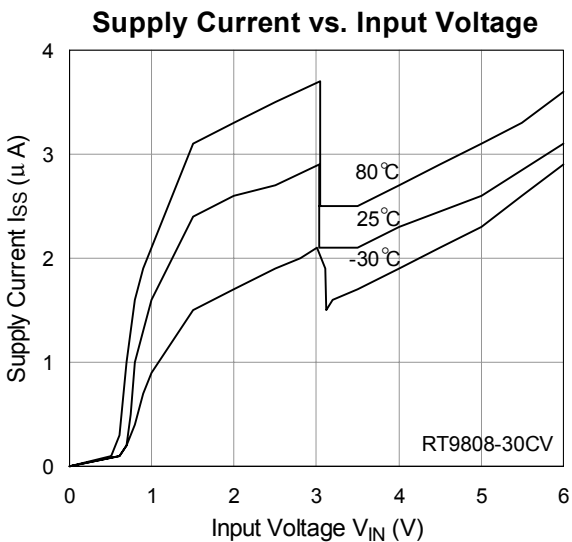
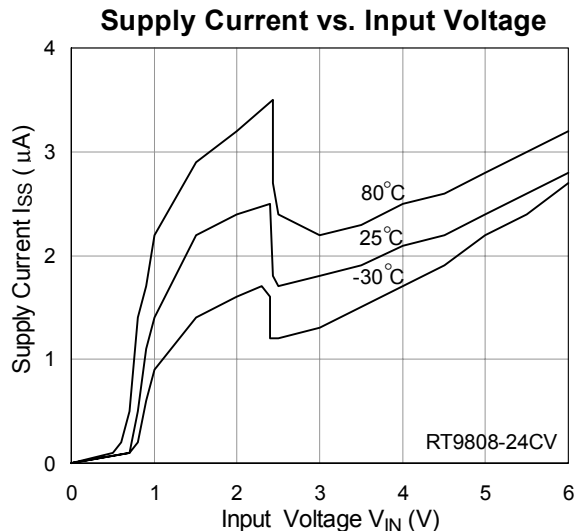
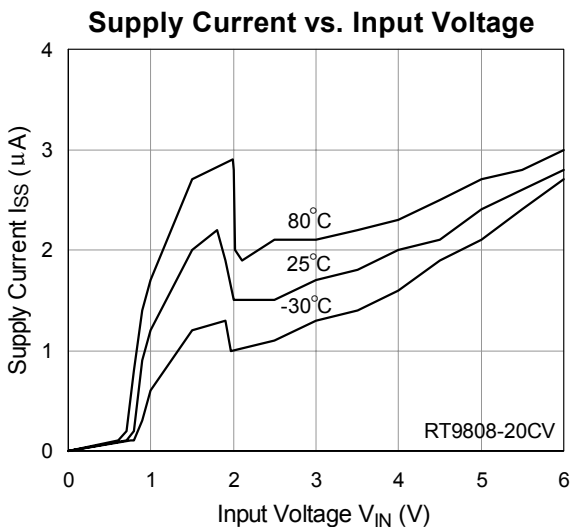

**Nch Driver Output Current vs. Input Voltage**

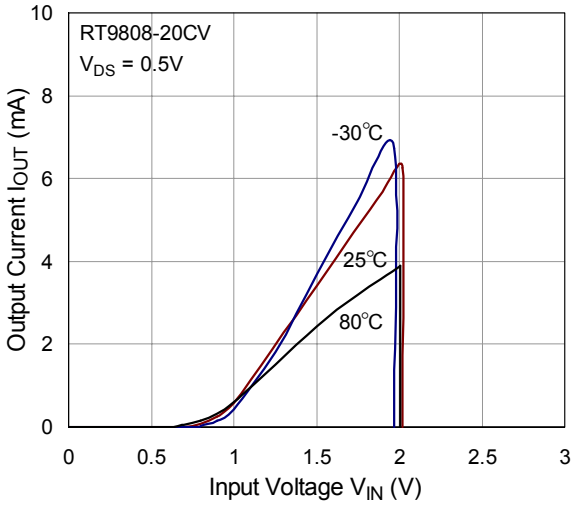

**Nch Driver Output Current vs. Input Voltage**

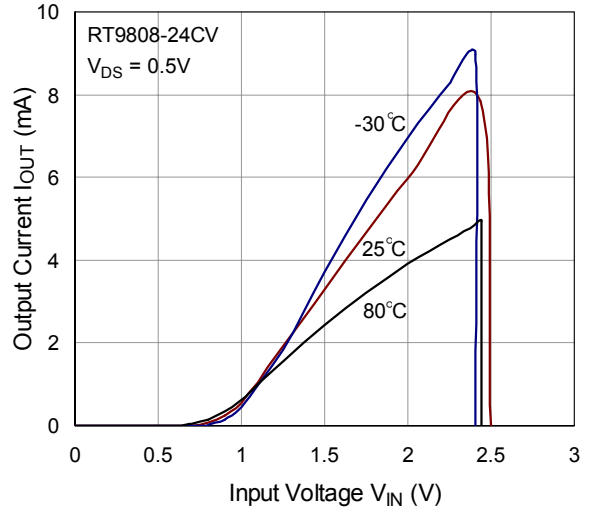

**Nch Driver Output Current vs. Input Voltage**

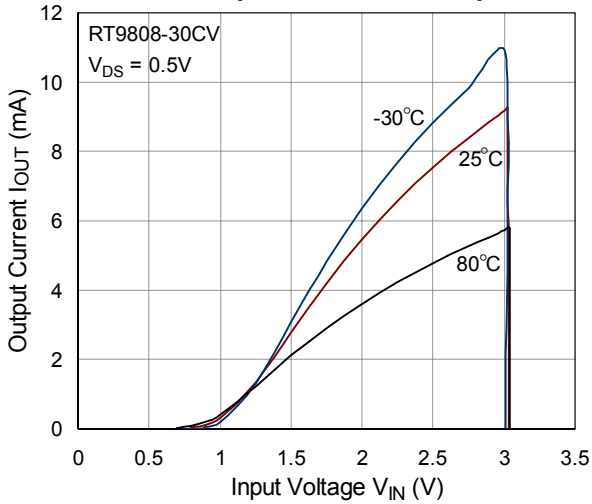

**Nch Driver Output Current vs. Input Voltage**

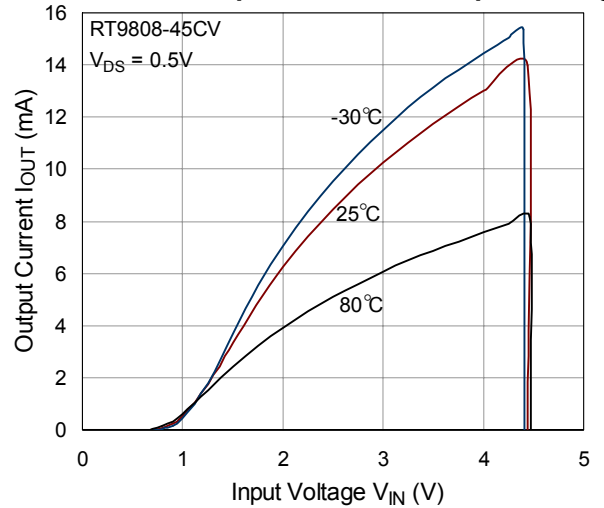

**Nch Driver Output Current vs. Input Voltage**

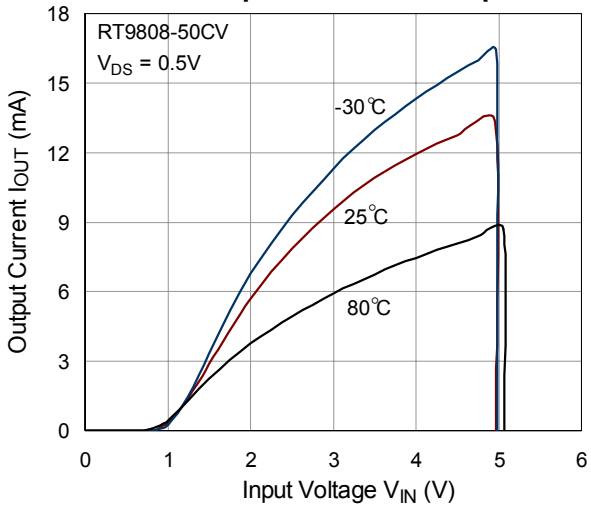

**Power-Up reset Timeout vs. Temp.**

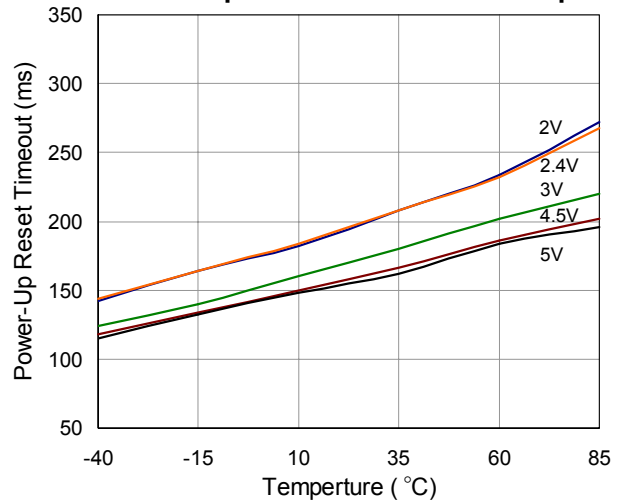

**Power-Down Reset Delay vs. Temp.**

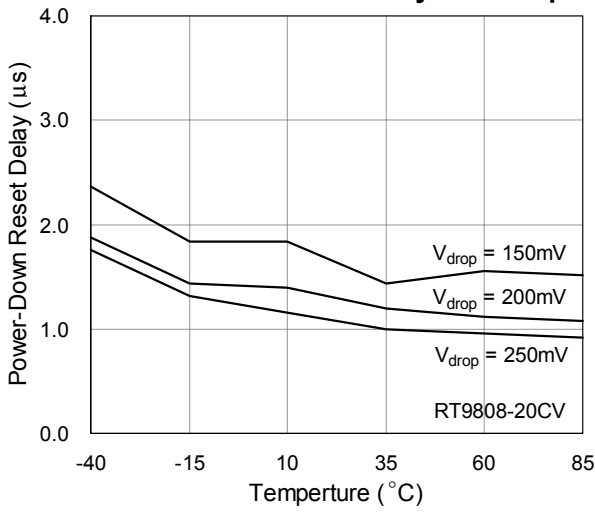

**Power-Down Reset Delay vs. Temp.**

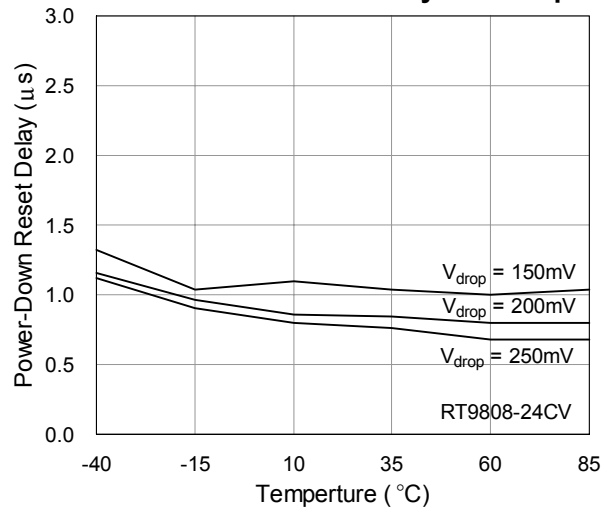

**Power-Down Reset Delay vs. Temp.**

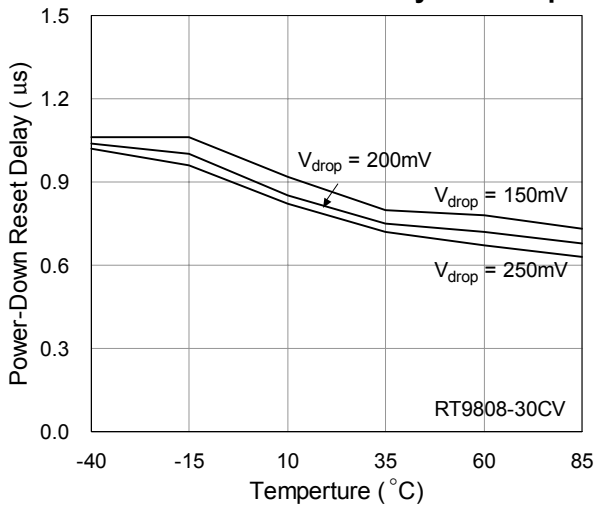

**Power-Down Reset Delay vs. Temp.**

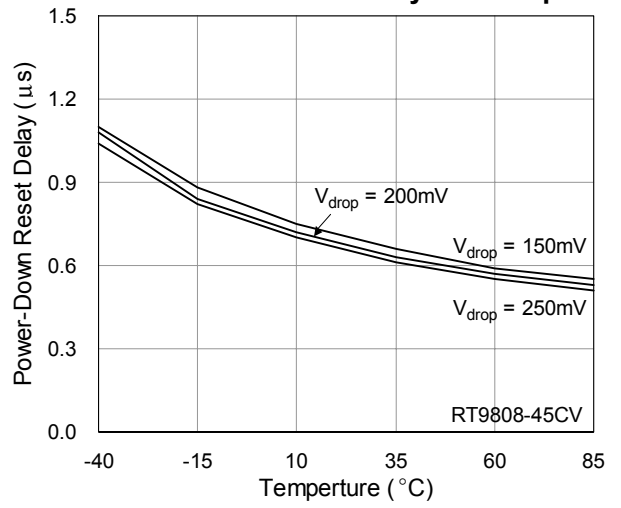

**Power-Down Reset Delay vs. Temp.**

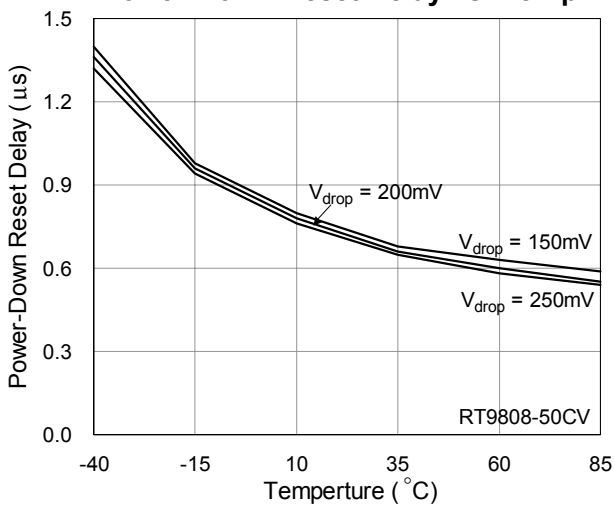

**Output Delay Time vs. Load Capacitance**

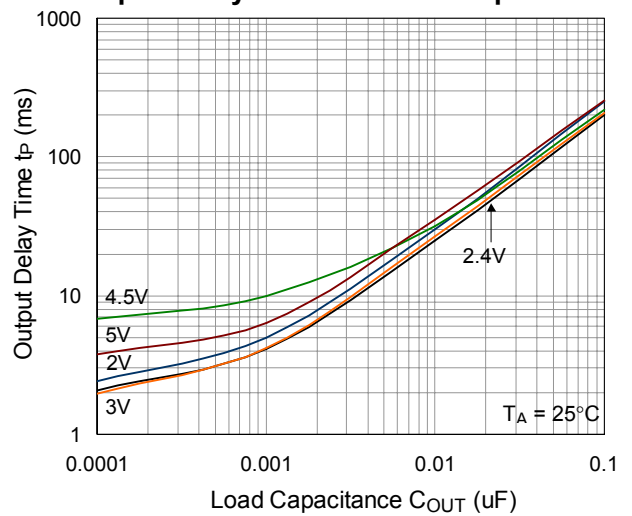



**Package Information**

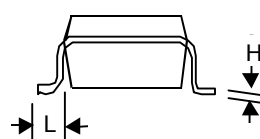
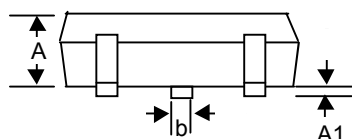
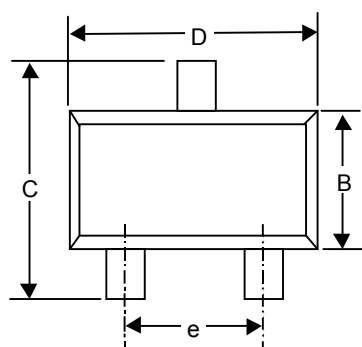

Symbol	Dimensions In Millimeters		Dimensions In Inches	
	Min	Max	Min	Max
A	0.889	1.295	0.035	0.051
A1	--	0.152	--	0.006
B	1.397	1.803	0.055	0.071
b	0.356	0.508	0.014	0.020
C	2.591	2.997	0.102	0.118
D	2.692	3.099	0.106	0.122
e	1.803	2.007	0.071	0.079
H	0.102	0.254	0.004	0.010
L	0.356	0.610	0.014	0.024

**SOT-23 Plastic Surface Mount**

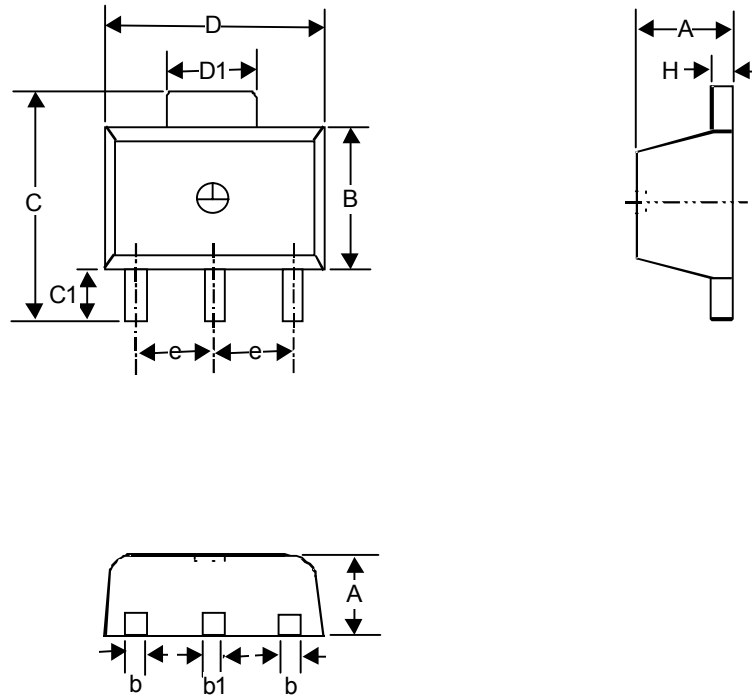

Symbol	Dimensions In Millimeters		Dimensions In Inches	
	Min	Max	Min	Max
A	1.397	1.600	0.055	0.063
b	0.356	0.483	0.014	0.019
B	2.388	2.591	0.094	0.102
b1	0.406	0.533	0.016	0.021
C	--	4.242	--	0.167
C1	0.787	1.194	0.031	0.047
D	4.394	4.597	0.173	0.181
D1	1.397	1.753	0.055	0.069
e	1.448	1.549	0.057	0.061
H	0.381	0.432	0.015	0.017

**3-Lead SOT-89 Surface Mount**

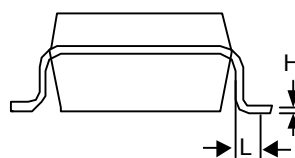
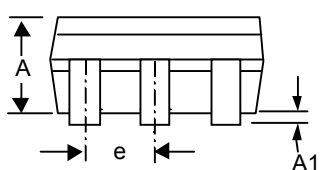
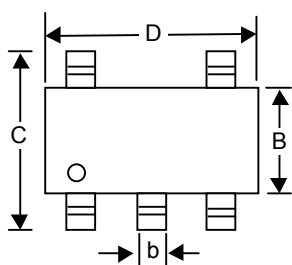

Symbol	Dimensions In Millimeters		Dimensions In Inches	
	Min	Max	Min	Max
A	0.889	1.295	0.035	0.051
A1	0.000	0.152	0.000	0.006
B	1.397	1.803	0.055	0.071
b	0.356	0.559	0.014	0.022
C	2.591	2.997	0.102	0.118
D	2.692	3.099	0.106	0.122
e	0.838	1.041	0.033	0.041
H	0.102	0.254	0.004	0.010
L	0.356	0.610	0.014	0.024

**SOT- 25 Surface Mount Package**

**RICHTEK TECHNOLOGY CORP.**

Headquarter

6F, No. 35, Hsintai Road, Chupei City

Hsinchu, Taiwan, R.O.C.

Tel: (8863)5510047 Fax: (8863)5537749

**RICHTEK TECHNOLOGY CORP.**

Taipei Office (Marketing)

8F-1, No. 137, Lane 235, Paochiao Road, Hsintien City

Taipei County, Taiwan, R.O.C.

Tel: (8862)89191466 Fax: (8862)89191465

Email: [marketing@richtek-ic.com.tw](mailto:marketing@richtek-ic.com.tw)