

## Contents

|                                  |    |
|----------------------------------|----|
| Features .....                   | 1  |
| Applications .....               | 1  |
| Options .....                    | 1  |
| Pin Assignment .....             | 1  |
| Pin Functions .....              | 1  |
| Block Diagram .....              | 2  |
| Selection Guide .....            | 3  |
| Absolute Maximim Ratings.....    | 4  |
| Electrical Characteristics ..... | 4  |
| Test Circuits.....               | 8  |
| Technical Terms .....            | 8  |
| Operation Timing Charts.....     | 9  |
| Operation .....                  | 10 |
| Dimensions .....                 | 12 |
| Markings .....                   | 12 |
| Taping .....                     | 13 |
| Transient Response .....         | 14 |
| Standard Curcuit.....            | 21 |
| Application Curcuits.....        | 21 |
| Notes.....                       | 22 |
| Characteristics .....            | 23 |

The S-87X Series are low-power high withstand-voltage voltage regulators with reset function, which integrate high-precision voltage detection and voltage regulation circuits on one chip. The S-87X Series have a higher withstand-voltage characteristic and a higher accuracy of detection voltage and output voltage, which is  $\pm 2.4\%$ , than our S-870 Series voltage regulators.

■ **Features**

- Accuracy of output voltage:  $\pm 2.4\%$  (3.0 V / 5.0 V)
- Accuracy of detection voltage:  $\pm 2.4\%$
- Low I/O voltage difference:
  - 0.15 V typ. at  $I_{OUT} = 30$  mA, 5.0 V
  - 0.45 V typ. at  $I_{OUT} = 30$  mA, 3.0 V
- Low current consumption: 8  $\mu$ A typ.
- Wide operating voltage range: 24.0 V max.
- Wide operating temperature range: -40°C to +85°C
- Built-in delay circuit and short-circuit protection circuit
- Small package: SOT-89-5

■ **Applications**

- Constant voltage power supply or reset circuit of battery-powered equipment, VTR, camera, communications equipment, or others.

■ **Pin Assignment**

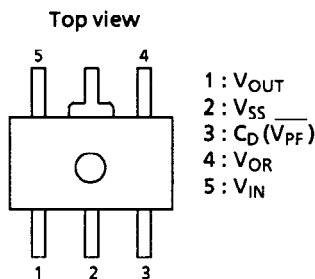

Figure 1 Pin assignment

■ **Pin Functions**

Table 1

| Pin No. | Name                | Functions                                                          |
|---------|---------------------|--------------------------------------------------------------------|
| 1       | $V_{OUT}$           | Voltage output pin of voltage regulator                            |
| 2       | $V_{SS}$            | Ground                                                             |
| 3       | $C_D$               | Connection pin of external capacitor for delay of voltage detector |
|         | $\overline{V_{PF}}$ | Input pin of shutdown circuit                                      |
| 4       | $V_{OR}$            | Output pin of voltage detector (Nch opendrain output)              |
| 5       | $V_{IN}$            | Positive power-supply input pin                                    |

# HIGH-WITHSTAND-VOLTAGE VOLTAGE REGULATOR WITH RESET FUNCTION S-87X Series

## ■ Block Diagram

- 1) Built-in delay circuit,  $V_{IN}$  detection  
(S-87XXXXA Series)

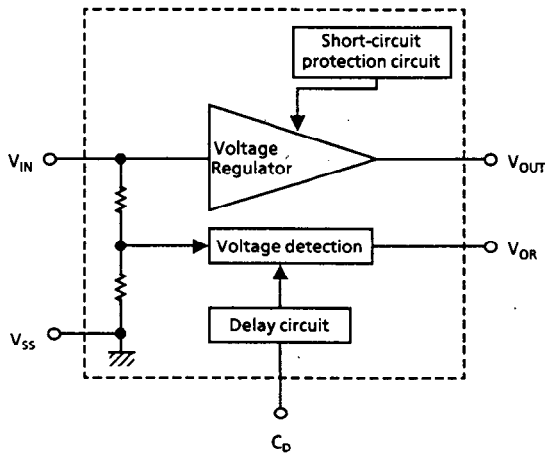

- 2) Built-in delay circuit,  $V_{OUT}$  detection  
(S-87XXXXB Series)

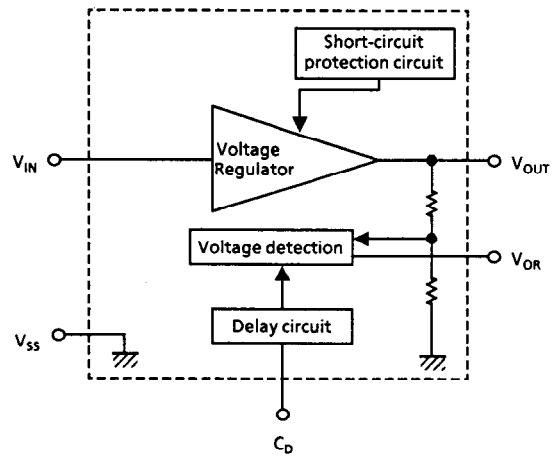

- 3) Built-in shutdown circuit (regulators only),  $V_{IN}$  detection  
(S-87XXXXC Series)

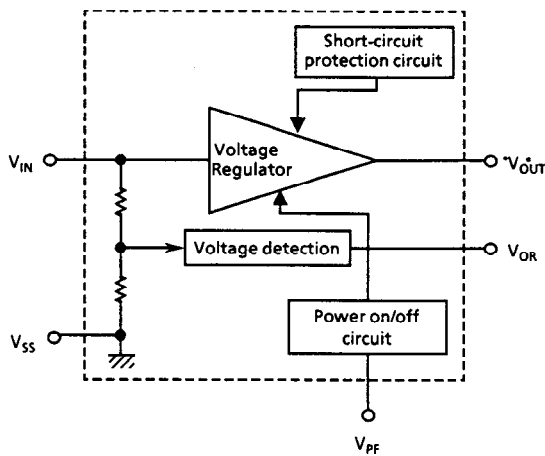

Figure 2 Block diagram

### ■ Selection Guide

#### 1. Series selection

Table 2

| Series name | Voltage detector (VD) | Built-in Delay circuit | Shutdown function |    |
|-------------|-----------------------|------------------------|-------------------|----|
|             |                       |                        | VR                | VD |
| S-87XXXXA   | Detects $V_{IN}$      | Yes                    | No                | No |
| S-87XXXXB   | Detects $V_{OUT}$     | Yes                    | No                | No |
| S-87XXXXC   | Detects $V_{IN}$      | No                     | Yes               | No |

#### 2. Product name

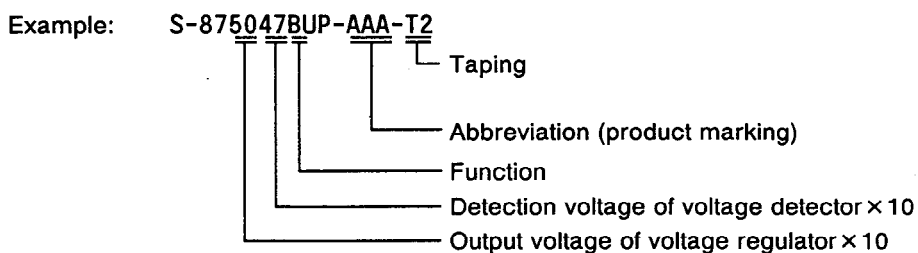

#### 3. Product List

| VR output voltage | VD detection voltage | S-87XXXXA Series   | S-87XXXXB Series   | S-87XXXXC Series   |
|-------------------|----------------------|--------------------|--------------------|--------------------|
| 5.0V              | 4.5V                 | S-875045AUP-AAA-T2 | S-875045BUP-ABA-T2 | S-875045CUP-ACA-T2 |
| 5.0V              | 4.3V                 | S-875043AUP-AAB-T2 | S-875043BUP-ABB-T2 | S-875043CUP-ACB-T2 |
| 5.0V              | 4.1V                 | S-875041AUP-AAC-T2 | S-875041BUP-ABC-T2 | S-875041CUP-ACC-T2 |
| 5.0V              | 3.9V                 | S-875039AUP-AAD-T2 | S-875039BUP-ABD-T2 | S-875039CUP-ACD-T2 |
| 5.0V              | 3.7V                 | S-875037AUP-AAE-T2 | S-875037BUP-ABE-T2 | S-875037CUP-ACE-T2 |
| 3.0V              | 2.5V                 | S-873025AUP-ADA-T2 | S-873025BUP-AEA-T2 | S-873025CUP-AFA-T2 |
| 3.0V              | 2.4V                 | S-873024AUP-ADB-T2 | S-873024BUP-AEB-T2 | S-873024CUP-AFB-T2 |
| 3.0V              | 2.3V                 | S-873023AUP-ADC-T2 | S-873023BUP-AEC-T2 | S-873023CUP-AFC-T2 |
| 3.0V              | 2.2V                 | S-873022AUP-ADD-T2 | S-873022BUP-AED-T2 | S-873022CUP-AFD-T2 |
| 3.0V              | 2.1V                 | S-873021AUP-ADE-T2 | S-873021BUP-AEE-T2 | S-873021CUP-AFE-T2 |

**Note** In the S-87XXXXB Series, if the output voltage of the voltage regulator is close to the detection voltage of the voltage detector, the transient response of the voltage regulator may be detection of an error. When selecting the voltage, take into account "Transient Response".

# HIGH-WITHSTAND-VOLTAGE VOLTAGE REGULATOR WITH RESET FUNCTION

## S-87X Series

### Absolute Maximum Ratings

Table 3

| Parameter                          | Symbol           | Ratings                          | Unit |
|------------------------------------|------------------|----------------------------------|------|
| Input voltage                      | $V_{IN}, V_{PF}$ | 26                               | V    |
| Output voltage                     | $V_{OUT}$        | $V_{IN} + 0.3$ to $V_{SS} - 0.3$ | V    |
| Output voltage of voltage detector | $V_{OR}$         | $V_{SS} - 0.3$ to 26             | V    |
| Power dissipation                  | $P_D$            | 500                              | mW   |
| Operating temperature              | $T_{opr}$        | -40 to +85                       | °C   |
| Storage temperature                | $T_{stg}$        | -40 to +125                      | °C   |

### Electrical Characteristics

#### 1. S-8750XXA/B Series

Table 4

(Unless otherwise specified:  $T_a = 25^\circ\text{C}$ )

| Parameter             | Symbol                             | Conditions                                          | Standard                                                                                           |                         |            | Unit          | Test cir.     |    |   |
|-----------------------|------------------------------------|-----------------------------------------------------|----------------------------------------------------------------------------------------------------|-------------------------|------------|---------------|---------------|----|---|
|                       |                                    |                                                     | Min.                                                                                               | Typ.                    | Max.       |               |               |    |   |
| Voltage regulator     | Output voltage                     | $V_{OUT}$                                           | $V_{IN} = 7\text{ V}, I_{OUT} = 30\text{ mA}$                                                      | 4.88                    | 5.00       | 5.12          | V             | 1  |   |
|                       | I/O voltage difference             | $V_{dif}$                                           | $I_{OUT} = 30\text{ mA}$                                                                           | —                       | 0.15       | 0.40          | V             | 1  |   |
|                       | Line regulation                    | $\Delta V_{OUT1}$                                   | $V_{IN} = 6$ to $24\text{ V}$<br>$I_{OUT} = 30\text{ mA}$                                          | —                       | 15         | 50            | mV            | 1  |   |
|                       | Load regulation                    | $\Delta V_{OUT2}$                                   | $V_{IN} = 7\text{ V}$<br>$I_{OUT} = 50\ \mu\text{A}$ to $40\text{ mA}$                             | —                       | 15         | 50            | mV            | 1  |   |
|                       | Input voltage                      | $V_{IN}$                                            |                                                                                                    | —                       | —          | 24            | V             | 1  |   |
|                       | Temp. coefficient of $V_{OUT}$     | $\frac{\Delta V_{OUT}}{\Delta T_a}$                 | $V_{IN} = 7\text{ V}, I_{OUT} = 30\text{ mA},$<br>$T_a = -40^\circ\text{C}$ to $+85^\circ\text{C}$ | —                       | $\pm 0.38$ | $\pm 1.52$    | mV/°C         | 1  |   |
| Voltage detector      | Operating voltage                  | $V_{SEN}$                                           |                                                                                                    | 1.3                     | —          | 24            | V             | 2  |   |
|                       | Delay time*1                       | $t_{pd}$                                            | $C_D = 4.7\text{ nF}$                                                                              | 15                      | 27         | 41            | ms            | 3  |   |
|                       | Temp. characteristic of $-V_{DET}$ | $\frac{\Delta -V_{DET}}{\Delta T_a}$                | $T_a = -40^\circ\text{C}$ to $+85^\circ\text{C}$                                                   | —                       | $\pm 0.5$  | $\pm 2.0$     | mV/°C         | 2  |   |
|                       | Detection voltage                  | $-V_{DET}$                                          | S-875045A/B                                                                                        | 4.392                   | 4.50       | 4.608         | V             | 2  |   |
|                       |                                    |                                                     | S-875043A/B                                                                                        | 4.196                   | 4.30       | 4.404         | V             | 2  |   |
|                       |                                    |                                                     | S-875041A/B                                                                                        | 4.001                   | 4.10       | 4.199         | V             | 2  |   |
|                       |                                    |                                                     | S-875039A/B                                                                                        | 3.806                   | 3.90       | 3.994         | V             | 2  |   |
|                       |                                    |                                                     | S-875037A/B                                                                                        | 3.611                   | 3.70       | 3.789         | V             | 2  |   |
|                       | Sink current                       | $I_{DOUT}$                                          | Nch<br>$V_{DS} = 0.5\text{ V}$                                                                     | $V_{IN} = 1.2\text{ V}$ | 0.25       | 0.60          | —             | mA | 4 |
|                       |                                    |                                                     |                                                                                                    | $V_{IN} = 2.4\text{ V}$ | 1.50       | 2.60          | —             | mA | 4 |
| Leakage current       | $I_{LEAK}$                         | Nch<br>$V_{DS} = 24\text{ V}, V_{IN} = 10\text{ V}$ | $V_{IN} = 3.6\text{ V}$                                                                            | 3.00                    | 4.50       | —             | mA            | 4  |   |
|                       |                                    |                                                     |                                                                                                    | —                       | —          | 0.1           | $\mu\text{A}$ | 4  |   |
| Hysteresis width      | $V_{HYS}$                          | S-875045A/B                                         | 1                                                                                                  | —                       | 2.5        | %             | 2             |    |   |
|                       |                                    | S-875043A/B, 41A/B,<br>39A/B, 37A/B                 | 3                                                                                                  | —                       | 8          | %             | 2             |    |   |
| Current consumption*2 | $I_{SS}$                           | $V_{IN} = 7\text{ V},$ Unloaded                     | —                                                                                                  | 3                       | 8          | $\mu\text{A}$ | 5             |    |   |

\*1  $t_{pd}(\text{ms}) = (3.18 \text{ min.}, 5.74 \text{ typ.}, 8.73 \text{ max.}) \times C_D(\text{nF})$

\*2 Excluding the charging current of  $C_D$

# HIGH-WITHSTAND-VOLTAGE VOLTAGE REGULATOR WITH RESET FUNCTION

## S-87X Series

### 2. S-8730XXA/B Series

**Table 5**

(Unless otherwise specified: Ta = 25°C)

|                     | Parameter                                 | Symbol                                                | Conditions                                                              | Standard                  |        |        | Unit  | Test cir. |   |
|---------------------|-------------------------------------------|-------------------------------------------------------|-------------------------------------------------------------------------|---------------------------|--------|--------|-------|-----------|---|
|                     |                                           |                                                       |                                                                         | Min.                      | Typ.   | Max.   |       |           |   |
| V Regulator         | Output voltage                            | V <sub>OUT</sub>                                      | V <sub>IN</sub> = 5 V, I <sub>OUT</sub> = 30 mA                         | 2.928                     | 3.000  | 3.072  | V     | 1         |   |
|                     | I/O voltage difference                    | V <sub>dif</sub>                                      | I <sub>OUT</sub> = 30 mA                                                | —                         | 0.45   | 0.70   | V     | 1         |   |
|                     | Line regulation                           | ΔV <sub>OUT1</sub>                                    | V <sub>IN</sub> = 4 to 24 V<br>I <sub>OUT</sub> = 30 mA                 | —                         | 15     | 50     | mV    | 1         |   |
|                     | Load regulation                           | ΔV <sub>OUT2</sub>                                    | V <sub>IN</sub> = 5 V<br>I <sub>OUT</sub> = 50 μA to 40 mA              | —                         | 15     | 50     | mV    | 1         |   |
|                     | Input voltage                             | V <sub>IN</sub>                                       |                                                                         | —                         | —      | 24     | V     | 1         |   |
|                     | Temp. coefficient of V <sub>OUT</sub>     | $\frac{\Delta V_{OUT}}{\Delta T_a}$                   | V <sub>IN</sub> = 5 V, I <sub>OUT</sub> = 30 mA,<br>Ta = -40°C to +85°C | —                         | ± 0.23 | ± 0.92 | mV/°C | 1         |   |
| Voltage detector    | Operating voltage                         | V <sub>SEN</sub>                                      |                                                                         | 1.3                       | —      | 24     | V     | 2         |   |
|                     | Delay time*1                              | t <sub>pd</sub>                                       | C <sub>D</sub> = 4.7 nF                                                 | 15                        | 27     | 41     | ms    | 3         |   |
|                     | Temp. characteristic of -V <sub>DET</sub> | $\frac{\Delta -V_{DET}}{\Delta T_a}$                  | Ta = -40°C to +85°C                                                     | —                         | ± 0.3  | ± 1.2  | mV/°C | 2         |   |
|                     | Detection voltage                         | -V <sub>DET</sub>                                     | S-873025A/B                                                             | 2.440                     | 2.500  | 2.560  | V     | 2         |   |
|                     |                                           |                                                       | S-873024A/B                                                             | 2.342                     | 2.400  | 2.458  | V     | 2         |   |
|                     |                                           |                                                       | S-873023A/B                                                             | 2.245                     | 2.300  | 2.356  | V     | 2         |   |
|                     |                                           |                                                       | S-873022A/B                                                             | 2.147                     | 2.200  | 2.253  | V     | 2         |   |
|                     |                                           |                                                       | S-873021A/B                                                             | 2.049                     | 2.100  | 2.151  | V     | 2         |   |
|                     | Sink current                              | I <sub>DOUT</sub>                                     | Nch<br>V <sub>DS</sub> = 0.5 V                                          | V <sub>IN</sub> = 1.3 V   | 0.25   | 0.60   | —     | mA        | 4 |
|                     |                                           |                                                       |                                                                         | V <sub>IN</sub> = 2.4 V*3 | 1.50   | 2.60   | —     | mA        | 4 |
| Leakage current     | I <sub>LEAK</sub>                         | Nch<br>V <sub>DS</sub> = 24 V, V <sub>IN</sub> = 10 V | —                                                                       | —                         | 0.1    | μA     | 4     |           |   |
| Hysteresis width*2  | V <sub>HYS</sub>                          |                                                       | 3                                                                       | —                         | 8      | %      | 2     |           |   |
| Current consumption | I <sub>SS</sub>                           | V <sub>IN</sub> = 5 V, Unloaded                       | —                                                                       | 3                         | 8      | μA     | 5     |           |   |

\*1 t<sub>pd</sub> (ms) = (3.18 min., 5.74 typ., 8.73 max.) × C<sub>D</sub> (nF)

\*2 Excluding the charging current of C<sub>D</sub>

\*3 S-873025A/B only

# HIGH-WITHSTAND-VOLTAGE VOLTAGE REGULATOR WITH RESET FUNCTION

## S-87X Series

### 3. S-8750XXC Series

Table 6

(Unless otherwise specified: Ta = 25°C)

| Parameter                                                               | Symbol                                    | Conditions                                                 | Standard                                                                |                         |        | Unit   | Test cir. |    |   |
|-------------------------------------------------------------------------|-------------------------------------------|------------------------------------------------------------|-------------------------------------------------------------------------|-------------------------|--------|--------|-----------|----|---|
|                                                                         |                                           |                                                            | Min.                                                                    | Typ.                    | Max.   |        |           |    |   |
| V<br>R<br>e<br>g<br>u<br>l<br>a<br>t<br>o<br>r                          | Output voltage                            | V <sub>OUT</sub>                                           | V <sub>IN</sub> = 7 V, I <sub>OUT</sub> = 30 mA                         | 4.88                    | 5.00   | 5.12   | V         | 1  |   |
|                                                                         | I/O voltage difference                    | V <sub>dif</sub>                                           | I <sub>OUT</sub> = 30 mA                                                | —                       | 0.15   | 0.40   | V         | 1  |   |
|                                                                         | Line regulation                           | ΔV <sub>OUT1</sub>                                         | V <sub>IN</sub> = 6 to 24 V<br>I <sub>OUT</sub> = 30 mA                 | —                       | 15     | 50     | mV        | 1  |   |
|                                                                         | Load regulation                           | ΔV <sub>OUT2</sub>                                         | V <sub>IN</sub> = 7 V<br>I <sub>OUT</sub> = 50 μA to 40 mA              | —                       | 15     | 50     | mV        | 1  |   |
|                                                                         | Input voltage                             | V <sub>IN</sub>                                            |                                                                         | —                       | —      | 24     | V         | 1  |   |
|                                                                         | Temp. coefficient of V <sub>OUT</sub>     | $\frac{\Delta V_{OUT}}{\Delta T_a}$                        | V <sub>IN</sub> = 7 V, I <sub>OUT</sub> = 30 mA,<br>Ta = -40°C to +85°C | —                       | ± 0.38 | ± 1.52 | mV/°C     | 1  |   |
|                                                                         | Power off output voltage                  | V <sub>OUTOFF</sub>                                        | V <sub>IN</sub> = 7 V,<br>V <sub>PF</sub> = "L" R <sub>L</sub> = 1 MΩ   | —                       | —      | 0.1    | V         | 6  |   |
| V<br>o<br>l<br>t<br>a<br>g<br>e<br>d<br>e<br>t<br>e<br>c<br>t<br>o<br>r | Operating voltage                         | V <sub>SEN</sub>                                           |                                                                         | 1.3                     | —      | 24     | V         | 2  |   |
|                                                                         | Temp. characteristic of -V <sub>DET</sub> | $\frac{\Delta -V_{DET}}{\Delta T_a}$                       | Ta = -40°C to +85°C                                                     | —                       | ± 0.5  | ± 2.0  | mV/°C     | 2  |   |
|                                                                         | Detection voltage                         | -V <sub>DET</sub>                                          | S-875045C                                                               |                         | 4.392  | 4.50   | 4.608     | V  | 2 |
|                                                                         |                                           |                                                            | S-875043C                                                               |                         | 4.196  | 4.30   | 4.404     | V  | 2 |
|                                                                         |                                           |                                                            | S-875041C                                                               |                         | 4.001  | 4.10   | 4.199     | V  | 2 |
|                                                                         |                                           |                                                            | S-875039C                                                               |                         | 3.806  | 3.90   | 3.994     | V  | 2 |
|                                                                         |                                           |                                                            | S-875037C                                                               |                         | 3.611  | 3.70   | 3.789     | V  | 2 |
|                                                                         | Sink current                              | I <sub>DOUT</sub>                                          | Nch<br>V <sub>DS</sub> = 0.5 V                                          | V <sub>IN</sub> = 1.2 V | 0.25   | 0.60   | —         | mA | 4 |
|                                                                         |                                           |                                                            |                                                                         | V <sub>IN</sub> = 2.4 V | 1.50   | 2.60   | —         | mA | 4 |
|                                                                         |                                           |                                                            |                                                                         | V <sub>IN</sub> = 3.6 V | 3.00   | 4.50   | —         | mA | 4 |
| Leakage current                                                         | I <sub>LEAK</sub>                         | Nch<br>V <sub>DS</sub> = 24 V, V <sub>IN</sub> = 10 V      | —                                                                       | —                       | 0.1    | μA     | 4         |    |   |
| Hysteresis width                                                        | V <sub>HYS</sub>                          | S-875045C                                                  |                                                                         | 1                       | —      | 2.5    | %         | 2  |   |
|                                                                         |                                           | S-875043C, 41C, 39C, 37C                                   |                                                                         | 3                       | —      | 8      | %         | 2  |   |
| Current consumption                                                     | I <sub>SS</sub>                           | V <sub>IN</sub> = 7 V, Unloaded                            |                                                                         | —                       | 3      | 8      | μA        | 5  |   |
|                                                                         | I <sub>of</sub>                           | V <sub>PF</sub> = "L": Power off,<br>V <sub>IN</sub> = 7 V |                                                                         | —                       | 1.5    | 3.5    | μA        | 5  |   |
| Shutdown input voltage                                                  | V <sub>IL</sub>                           | V <sub>PF</sub> = "L": Power off,<br>V <sub>IN</sub> = 7 V |                                                                         | —                       | —      | 0.4    | V         | 6  |   |
|                                                                         | V <sub>IH</sub>                           | V <sub>PF</sub> = "H": Power on,<br>V <sub>IN</sub> = 7 V  |                                                                         | 2.0                     | —      | —      | V         | 6  |   |

# HIGH-WITHSTAND-VOLTAGE VOLTAGE REGULATOR WITH RESET FUNCTION

## S-87X Series

### 4. S-8730XXC Series

**Table 7**

(Unless otherwise specified: Ta = 25°C)

| Parameter                | Symbol                                    | Conditions                                                 | Standard                                                                |                         |      | Unit  | Test cir. |        |       |   |
|--------------------------|-------------------------------------------|------------------------------------------------------------|-------------------------------------------------------------------------|-------------------------|------|-------|-----------|--------|-------|---|
|                          |                                           |                                                            | Min.                                                                    | Typ.                    | Max. |       |           |        |       |   |
| Voltage regulator        | Output voltage                            | V <sub>OUT</sub>                                           | V <sub>IN</sub> = 5 V, I <sub>OUT</sub> = 30 mA                         |                         |      | 2.928 | 3.000     | 3.072  | V     | 1 |
|                          | I/O voltage difference                    | V <sub>dif</sub>                                           | I <sub>OUT</sub> = 30 mA                                                |                         |      | —     | 0.45      | 0.70   | V     | 1 |
|                          | Line regulation                           | ΔV <sub>OUT1</sub>                                         | V <sub>IN</sub> = 4 to 24 V<br>I <sub>OUT</sub> = 30 mA                 |                         |      | —     | 15        | 50     | mV    | 1 |
|                          | Load regulation                           | ΔV <sub>OUT2</sub>                                         | V <sub>IN</sub> = 5 V<br>I <sub>OUT</sub> = 50 μA to 40 mA              |                         |      | —     | 15        | 50     | mV    | 1 |
|                          | Input voltage                             | V <sub>IN</sub>                                            |                                                                         |                         |      | —     | —         | 24     | V     | 1 |
|                          | Temp. coefficient of V <sub>OUT</sub>     | $\frac{\Delta V_{OUT}}{\Delta T_a}$                        | V <sub>IN</sub> = 5 V, I <sub>OUT</sub> = 30 mA,<br>Ta = -40°C to +85°C |                         |      | —     | ± 0.23    | ± 0.92 | mV/°C | 1 |
|                          | Power off output voltage                  | V <sub>OUTOFF</sub>                                        | V <sub>IN</sub> = 5 V,<br>V <sub>PF</sub> = "L" R <sub>L</sub> = 1 MΩ   |                         |      | —     | —         | 0.1    | V     | 6 |
| Voltage detector         | Operating voltage                         | V <sub>SEN</sub>                                           |                                                                         |                         |      | 1.3   | —         | 24     | V     | 2 |
|                          | Temp. characteristic of -V <sub>DET</sub> | $\frac{\Delta -V_{DET}}{\Delta T_a}$                       | Ta = -40°C to +85°C                                                     |                         |      | —     | ± 0.3     | ± 1.2  | mV/°C | 2 |
|                          | Detection voltage                         | -V <sub>DET</sub>                                          | S-873025C                                                               |                         |      | 2.440 | 2.500     | 2.560  | V     | 2 |
|                          |                                           |                                                            | S-873024C                                                               |                         |      | 2.342 | 2.400     | 2.458  | V     | 2 |
|                          |                                           |                                                            | S-873023C                                                               |                         |      | 2.244 | 2.300     | 2.356  | V     | 2 |
|                          |                                           |                                                            | S-873022C                                                               |                         |      | 2.147 | 2.200     | 2.253  | V     | 2 |
|                          |                                           |                                                            | S-873021C                                                               |                         |      | 2.049 | 2.100     | 2.151  | V     | 2 |
|                          | Sink current                              | I <sub>DOUT</sub>                                          | Nch<br>V <sub>DS</sub> = 0.5 V                                          | V <sub>IN</sub> = 1.3 V | 0.25 | 0.60  | —         | mA     | 4     |   |
| V <sub>IN</sub> = 2.4 V* |                                           |                                                            |                                                                         | 1.50                    | 2.60 | —     | mA        | 4      |       |   |
| Leakage current          | I <sub>LEAK</sub>                         | Nch<br>V <sub>DS</sub> = 24 V, V <sub>IN</sub> = 10 V      |                                                                         |                         | —    | —     | 0.1       | μA     | 4     |   |
| Hysteresis width         | V <sub>HYS</sub>                          |                                                            |                                                                         |                         | 3    | —     | 8         | %      | 2     |   |
| Current consumption      | I <sub>SS</sub>                           | V <sub>IN</sub> = 5 V, Unloaded                            |                                                                         |                         | —    | 3     | 8         | μA     | 5     |   |
|                          | I <sub>of</sub>                           | V <sub>PF</sub> = "L": Power off,<br>V <sub>IN</sub> = 5 V |                                                                         |                         | —    | 1.5   | 3.5       | μA     | 5     |   |
| Shutdown input voltage   | V <sub>IL</sub>                           | V <sub>PF</sub> = "L": Power off,<br>V <sub>IN</sub> = 5 V |                                                                         |                         | —    | —     | 0.4       | V      | 6     |   |
|                          | V <sub>IH</sub>                           | V <sub>PF</sub> = "H": Power on,<br>V <sub>IN</sub> = 5 V  |                                                                         |                         | 2.0  | —     | —         | V      | 6     |   |

\* S-873025C only



■ **Test Circuits**

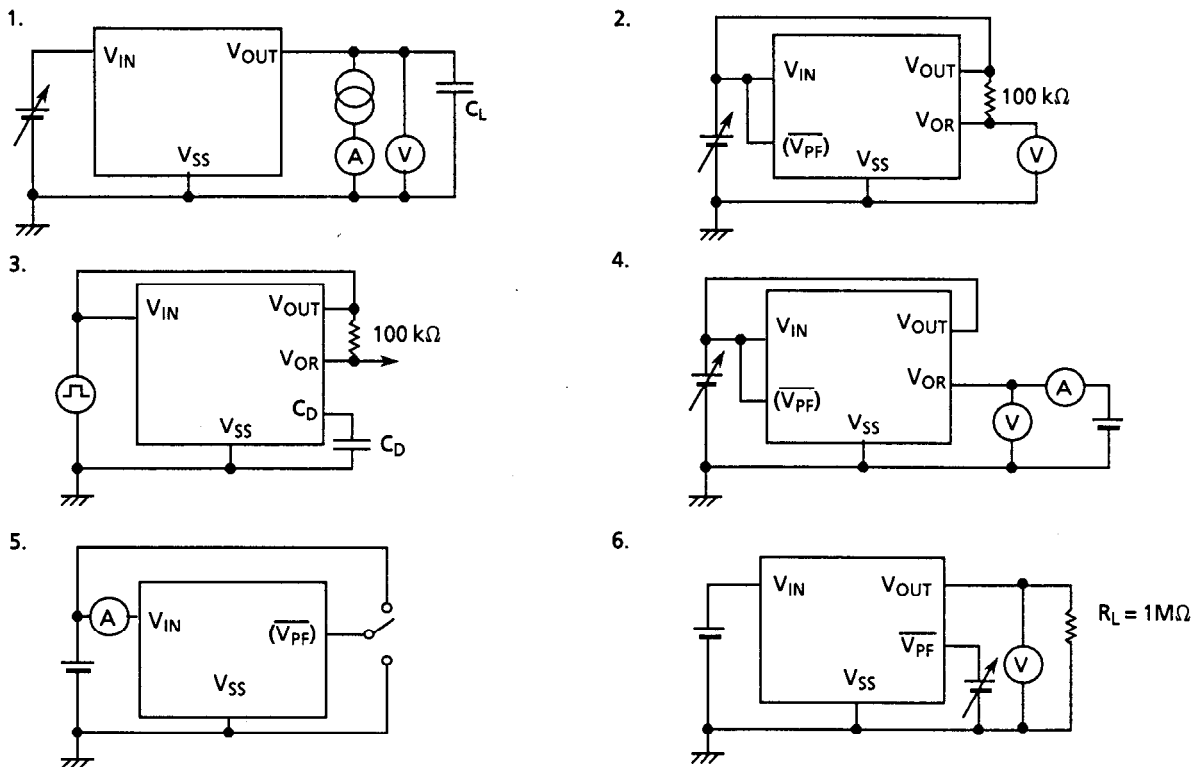

Figure 3 Test circuits

■ **Technical Terms**

- I/O voltage difference ( $V_{dif}$ )

$$V_{dif} = V_{IN1} - V_{OUT1}$$

$V_{OUT1}$ : Initial output voltage

$V_{IN1}$ : Input voltage which generates an output voltage ( $V_{OUT2}$ ) decreased by 5% from  $V_{OUT1}$

- Load regulation ( $\Delta V_{OUT2}$ )

$$\Delta V_{OUT2} = V_{OUT1} - V_{OUT2}$$

$V_{OUT1}$ : Output voltage when  $I_{OUT}$  is 50  $\mu A$

$V_{OUT2}$ : Output voltage when  $I_{OUT}$  is 40 mA

- Line regulation ( $\Delta V_{OUT1}$ )

$$\Delta V_{OUT1} = V_{OUT1} - V_{OUT2}$$

$V_{OUT1}$ : Output voltage when  $V_{IN}$  is 24 V

$V_{OUT2}$ : Output voltage when  $V_{IN}$  is ( $V_{OUT} + 1$ ) V

■ **Operation Timing Charts**

1. Voltage regulator (S-87XXXXC Series)

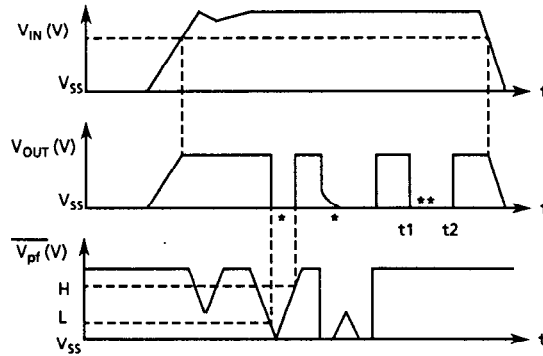

- \* Indicates shutdown status. When load current ( $I_{OUT}$ ) is less than  $1 \mu A$ ,  $V_{OUT}$  is not always  $V_{SS}$  level.
- \*\* When  $V_{OUT}$  is shorted at  $t_1$ ,  $V_{OUT}$  becomes  $V_{SS}$  level. When short of  $V_{OUT}$  is removed at  $t_2$ ,  $V_{OUT}$  returns to normal.

Figure 4

2. Voltage detector (S-87XXXXA/B Series)

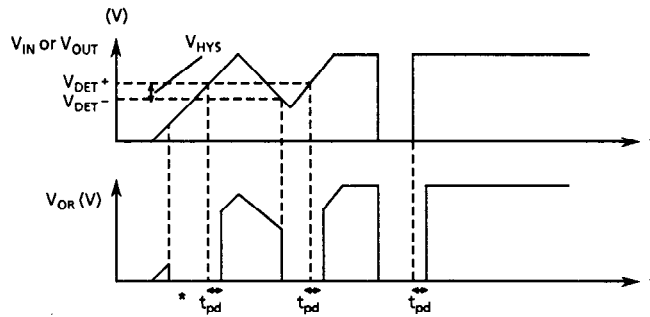

- \* Output delay time ( $t_{pd}$ ) of the voltage detector can be changed with an external capacitance value to  $C_D$  pin.
- \*\* Delay time is not available in S-87XXXXC Series.

Figure 5

■ **Operation**

1. Reference voltage circuit

The reference voltage circuits operate all the time while voltage is applied to  $V_{IN}$  pin independently of  $\overline{V_{PF}}$  signal.

2. Voltage regulator

Figure 6 shows the voltage regulator circuit. The S-87X Series has a Pch MOS transistor as the output control transistor.

Reverse current may break IC if  $V_{OUT}$  potential is higher than  $V_{IN}$ , because a parasitic diode is formed between  $V_{IN}$  and  $V_{OUT}$  due to the structure of the control transistor. Therefore, keep  $V_{OUT}$  lower than  $V_{IN} + 0.3$  V.

The output voltage of the voltage regulator can be selected as follows :

- 3V system : 2.9V to 3.4V (0.1V step)  $\pm 2.4\%$
- 5V system : 4.7V to 5.2V (0.1V step)  $\pm 2.4\%$

**Note** For an application with a load current of less than 1  $\mu A$ , the leakage current of the control transistor M1 increases the output voltage.

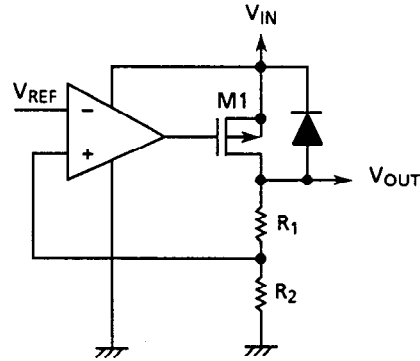

Figure 6 Voltage regulator circuit

3. Short-circuit protection circuit

The S-87X Series has a built-in short-circuit protection circuit to protect the element from break caused by a large current in case of a short circuit. The output short current is internally limited to approx. 70 mA. Short-circuit protection circuit has three kinds characteristics according to  $V_{IN}$  (input voltage) as shown in Figure 7.

At 5-V output:

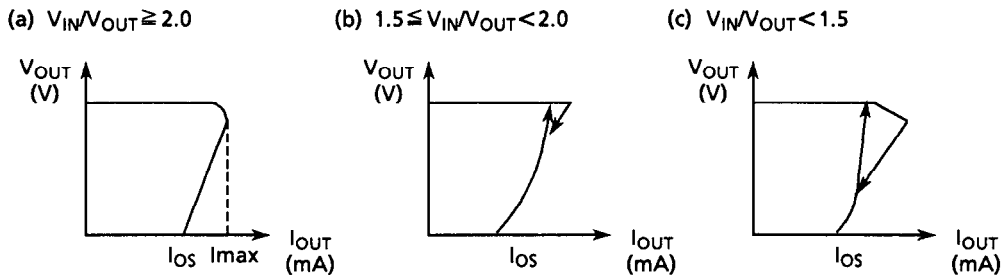

Figure 7

**Note** Use a voltage regulator with  $I_{OS}$  under the specified power dissipation of the package.

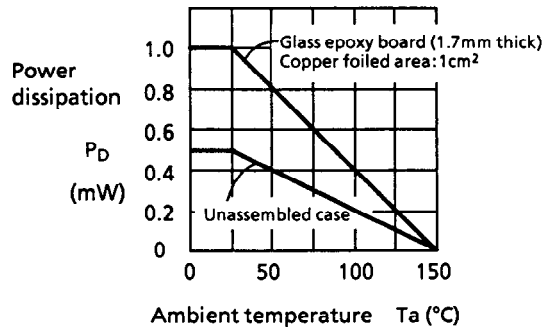

Figure 8 Power dissipation of the package (when not mounted)

#### 4. Delay circuit

The delay circuit outputs voltage detector output ( $V_{OR}$ ) with delay after the voltage at  $V_{IN}$  pin has become release voltage ( $+V_{DET}$ ) at the rising of  $V_{IN}$  pin.

In Fig. 9, when  $V_{cd}$  exceeds the reference voltage ( $V_{ref}$ ), the output voltage pin  $V_{OR}$  changes from low to high level, providing delay output. When the voltage at  $V_{IN}$  pin falls under the detection voltage ( $-V_{DET}$ ), the  $N_2$  transistor turns ON, therefore the charge of  $C_D$  is rapidly discharged and the voltage detector output ( $V_{OR}$ ) changes from high to low level without delay.

The external capacitor ( $C_D$ ) is charged with constant current, and is practically independent of  $V_{IN}$  voltage. Its delay time ( $t_{pd}$ ) is expressed by the following equation:

$$t_{pd} \text{ (ms)} = \text{Delay coefficient (3.18 min., 5.74 typ., 8.73 max.)} \times C_D \text{ (nF)}$$

**Note** · Unless an output delay is needed, keep  $C_D$  pin open.

Do not apply external voltage other than ground potential to  $C_D$  pins, which may cause IC breakdown.

- When designing your printed-circuit board layout, take care that no leakage current flows to the external capacitor ( $C_D$ ), otherwise the correct delay time may not be obtained. Because the value of the constant current source  $I_C$  is only 195 nA,  $C_D$  terminal impedance is high.

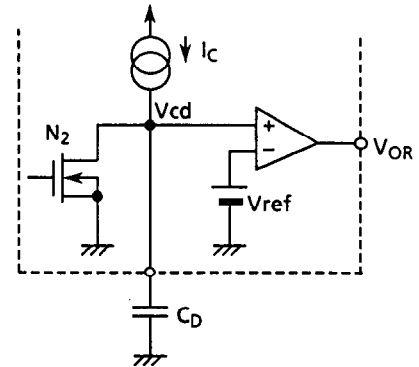

**Figure 9 Delay circuit**

#### 5. Voltage detection circuit

The built-in voltage detection circuit (Nch opendrain type) is equivalent to our S-807 Series voltage detectors. A pull-up resistor of 100 k $\Omega$  is required for output. Since the comparator power of this circuit is supplied from  $V_{IN}$  pin, this circuit operates while voltage is applied to  $V_{IN}$  pin.

The detection voltage of the voltage detector can be selected as follows :

3V system : 2.0V to 3.0V (0.1V step)  $\pm 2.4\%$

5V system : 3.7V to 4.7V (0.1V step)  $\pm 2.4\%$

#### 6. Shutdown circuit (S-87XXXXC Series)

In the S-87XXXXC Series, when  $\overline{V_{PF}}$  pin goes low (0.4 V or less), current for the voltage regulator is shut down, with the current consumption (excluding the current which flows through the pull-up resistor) lowered to 3.5  $\mu$ A or less.

During shutdown, the M1 transistor in the voltage regulator shown in the Figure 6 is off and  $V_{OUT}$  pin is pulled down by R1 and R2, whose value ( $R1 + R2$ ) is 5M $\Omega$  to 10M $\Omega$ .

**Note**

- The output voltage may not become 0 V if a load making  $I_{OUT}$  under 50  $\mu$ A is connected during shutdown, .
- Do not keep  $\overline{V_{PF}}$  pin floating state or in medium potential (between low and high levels) , Otherwise a through-type current occurs.

**HIGH WITHSTAND-VOLTAGE VOLTAGE REGULATOR WITH RESET FUNCTION**  
**S-87X Series**

■ **Dimensions**

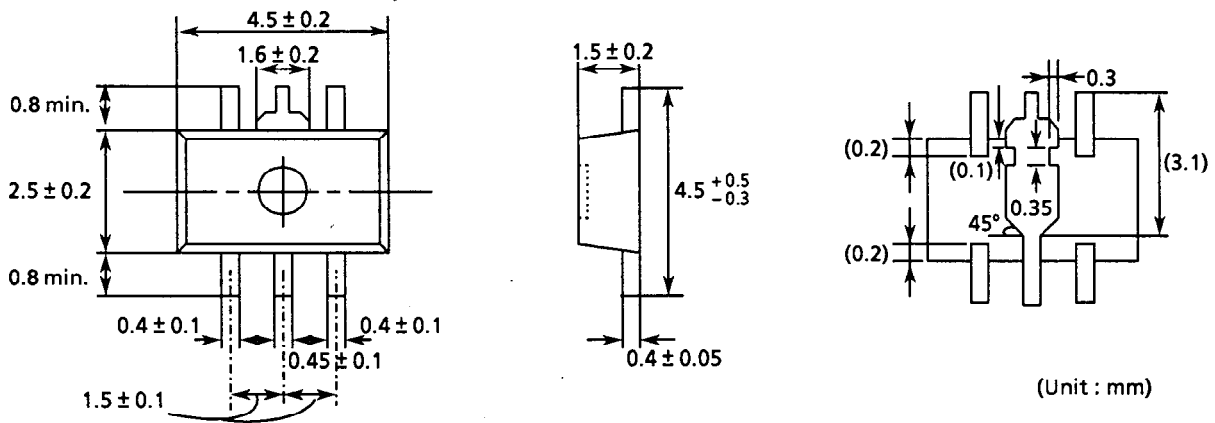

Figure 10 Dimensions

■ **Markings**

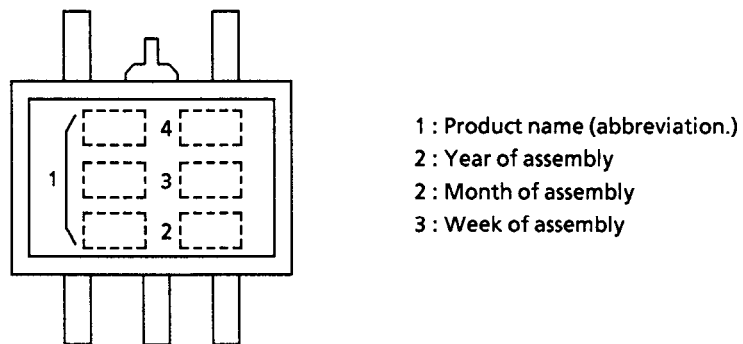

Figure 11 Markings

■ Taping

1 Tape specifications

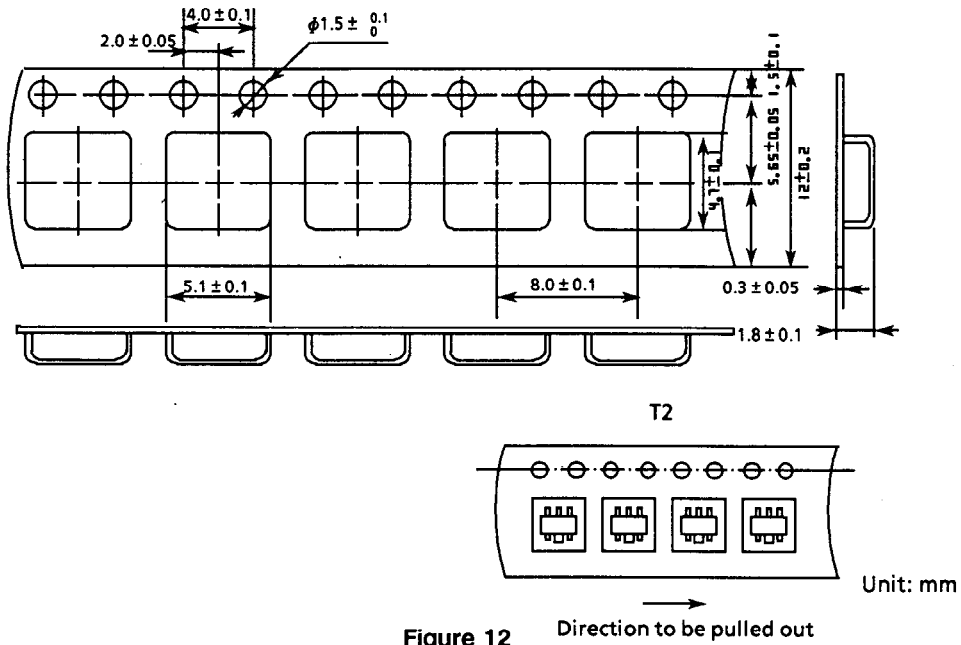

Figure 12

2. Reel specifications

1 reel holds 1000 regulators.

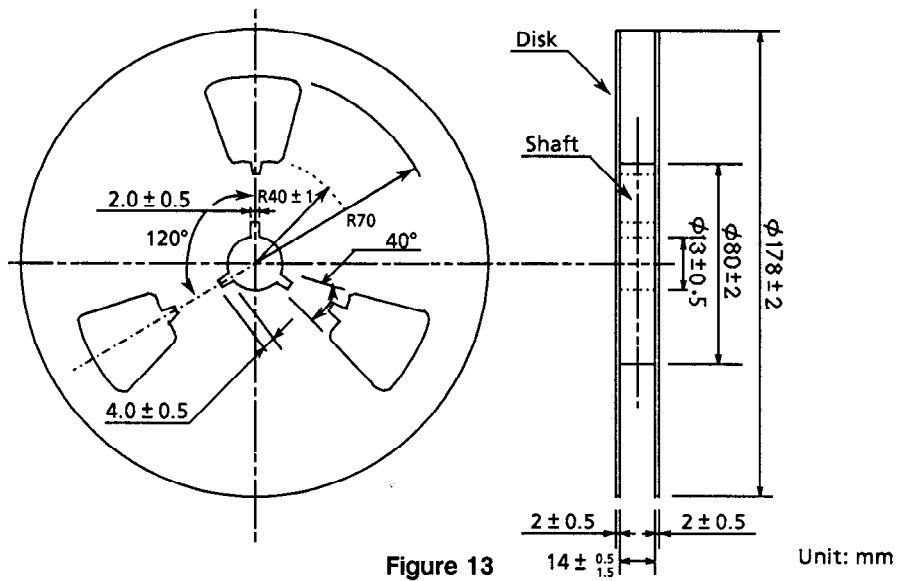

Figure 13

# HIGH WITHSTAND-VOLTAGE VOLTAGE REGULATOR WITH RESET FUNCTION

## S-87X Series

### ■ Transient Response

An undershoot or an overshoot may occur in the output voltage of the voltage regulator if input voltage or load current fluctuates transiently. If an undershoot is large, the voltage detector operates to output reset signal in the S-87XXXXB Series in which the voltage detector detects the output voltage of the regulator. If an overshoot is large, the load circuit is adversely affected. Therefore it is important to determine the capacitor value so as to minimize undershoot and overshoot.

#### 1. Line transient response due to input voltage fluctuation

Input voltage fluctuation differs depending on the types of the signal applied: type I which is a rectangular wave between  $(V_{OUT} + 1)$  V and 10 V, and type II which is a rectangular wave from 0 V to 10 V (see Figure 14). The ringing waveforms and parameter dependency of each type are described below. The measuring circuit is shown in Figure 15 for reference.

##### Type I: Rectangular wave between $(V_{OUT} + 1)$ V and 10 V

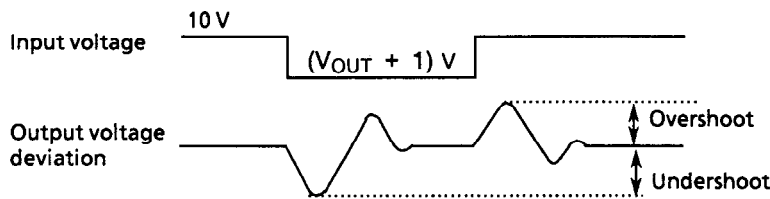

##### Type II: Rectangular wave from 0 V to 10 V

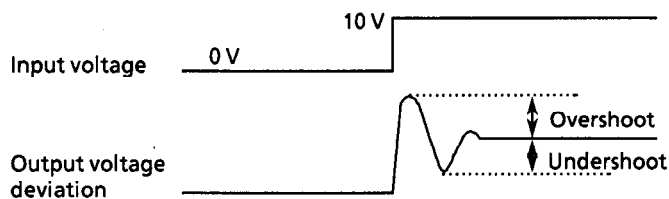

Rise/fall time (time between 10% and 90%) is  $1\mu\text{s}$ .

Figure 14

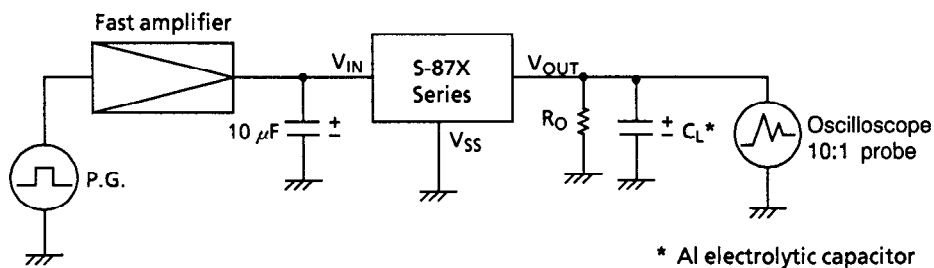
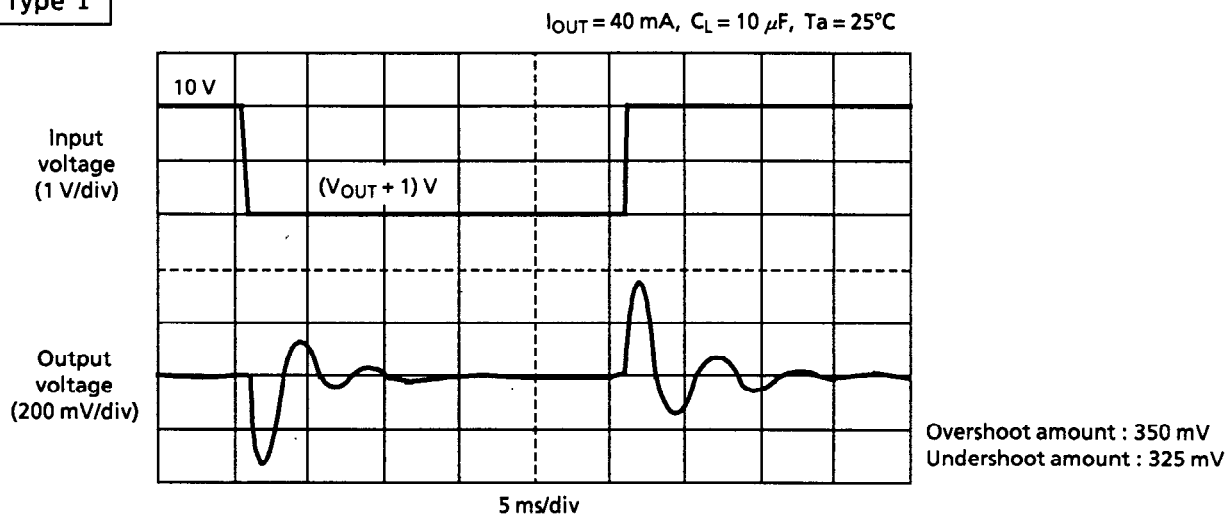

Figure 15 Measuring circuit

**Type I**



**Figure 16 Type I ringing waveform**

**Table 10 Type I parameter dependency**

| Series            | Parameter                           | Conditions                                        | Method to decrease overshoot | Method to decrease undershoot |
|-------------------|-------------------------------------|---------------------------------------------------|------------------------------|-------------------------------|
| S-8750XXX         | Load current $I_{OUT}$              | 10 to 60 mA, $C_L = 10 \mu\text{F}$               | Decrease                     | Decrease                      |
|                   | Load capacitance $C_L$              | 1 to 47 $\mu\text{F}$ , $I_{OUT} = 40 \text{ mA}$ | Increase                     | Increase                      |
|                   | Input fluctuation $\Delta V_{IN}^*$ | 3 to 5 V<br>5 to 19 V                             | Decrease                     | Decrease                      |
|                   |                                     |                                                   | Increase                     | Decrease                      |
| Temperature $T_a$ | -40°C to +85°C                      | Low temperature                                   | Low temperature              |                               |
| S-8730XXX         | Load current $I_{OUT}$              | 10 to 60 mA, $C_L = 10 \mu\text{F}$               | Increase                     | Decrease                      |
|                   | Load capacitance $C_L$              | 1 to 47 $\mu\text{F}$ , $I_{OUT} = 40 \text{ mA}$ | Increase                     | Increase                      |
|                   | Input fluctuation $\Delta V_{IN}^*$ | 5 to 21 V                                         | Increase                     | Decrease                      |
|                   | Temperature $T_a$                   | -40°C to +85°C                                    | Low temperature              | Low temperature               |

\*  $\Delta V_{IN}$  : High voltage value – low voltage value



Type II

$I_{OUT} = 40 \text{ mA}$ ,  $C_L = 10 \mu\text{F}$ ,  $T_a = 25^\circ\text{C}$

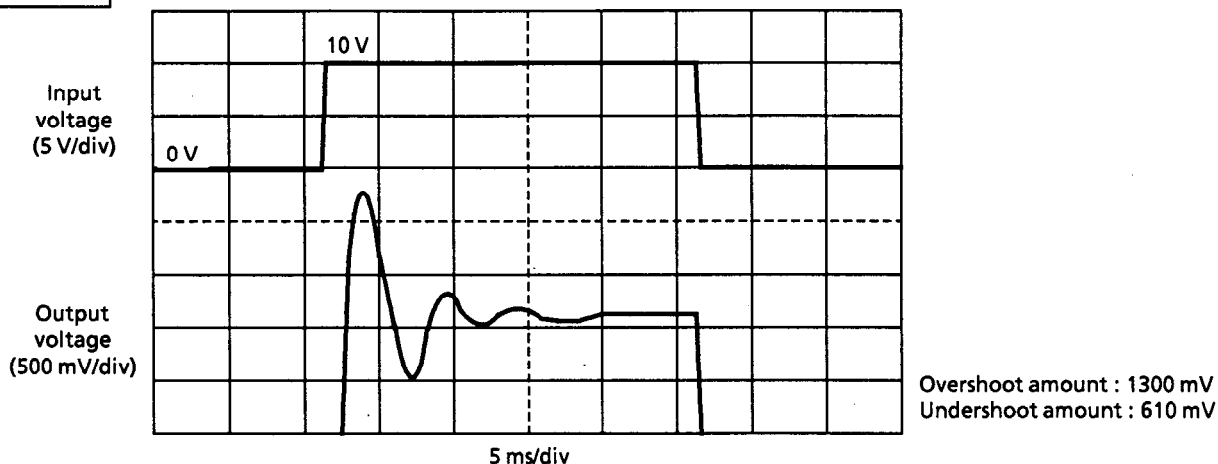

Figure 17 Type II ringing waveform

Table 11 Type II parameter dependency

| Series    | Parameter                           | Conditions                                        | Method to decrease overshoot | Method to decrease undershoot |
|-----------|-------------------------------------|---------------------------------------------------|------------------------------|-------------------------------|
| S-8750XXX | Load current $I_{OUT}$              | 10 to 60 mA, $C_L = 10 \mu\text{F}$               | Increase                     | Increase                      |
|           | Load capacitance $C_L$              | 1 to 47 $\mu\text{F}$ , $I_{OUT} = 40 \text{ mA}$ | Decrease                     | Decrease                      |
|           | Input fluctuation $\Delta V_{IN}^*$ | 3 to 19 V                                         | Increase                     | Increase                      |
|           | Temperature $T_a$                   | $-40^\circ\text{C}$ to $+85^\circ\text{C}$        | Low temperature              | Low temperature               |
| S-8730XXX | Load current $I_{OUT}$              | 10 to 60 mA, $C_L = 10 \mu\text{F}$               | Increase                     | Increase                      |
|           | Load capacitance $C_L$              | 1 to 47 $\mu\text{F}$ , $I_{OUT} = 40 \text{ mA}$ | Decrease                     | Decrease                      |
|           | Input fluctuation $\Delta V_{IN}^*$ | 5 to 21 V                                         | Increase                     | Increase                      |
|           | Temperature $T_a$                   | $-40^\circ\text{C}$ to $+85^\circ\text{C}$        | Low temperature              | Low temperature               |

\*  $\Delta V_{IN}$ : High voltage value – low voltage value

For reference, the following pages describe the ringing in  $V_{OUT}$  measured using the output load current ( $I_{OUT}$ ), output load capacitance ( $C_L$ ), input fluctuation width ( $\Delta V_{IN}$ ), and temperature as parameters.

**Reference data: Type I**      **S-8750XXX series**

1.  $I_{OUT}$  dependency

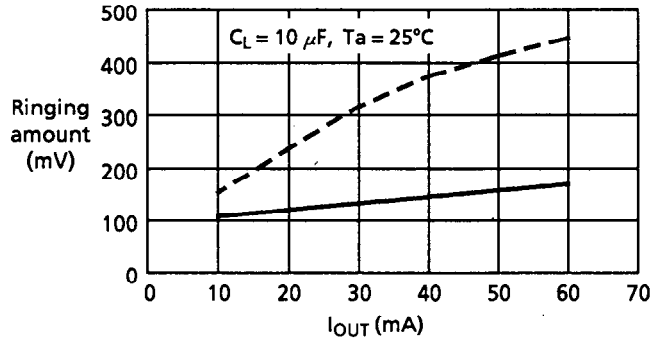

2.  $C_L$  dependency

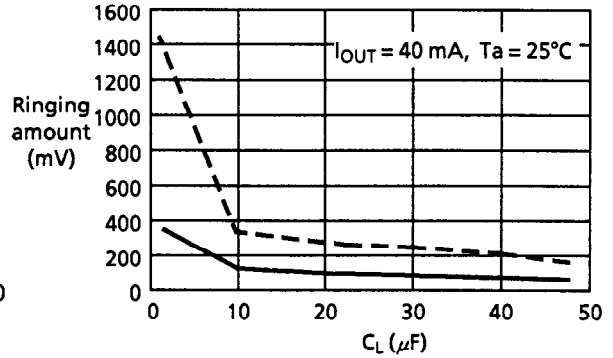

3.  $\Delta V_{IN}$  dependency

The lower voltage is fixed at  $(V_{OUT} + 1)$ .

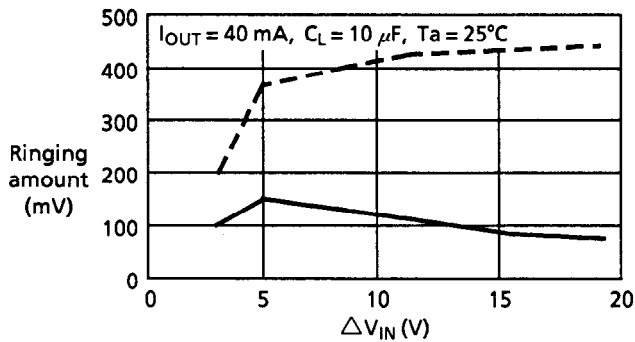

4. Temperature dependency

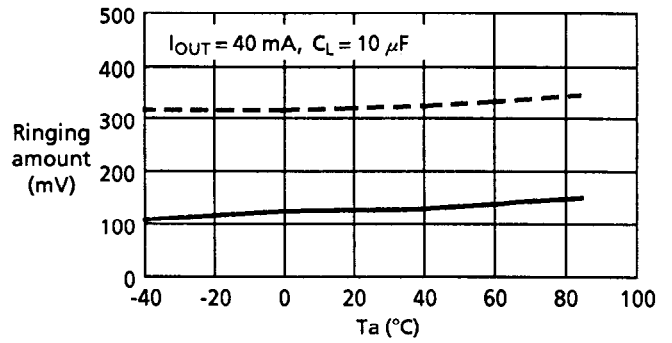

— Undershoot  
 - - - Overshoot

**Reference data: Type I**      **S-8730XXX series**

1.  $I_{OUT}$  dependency

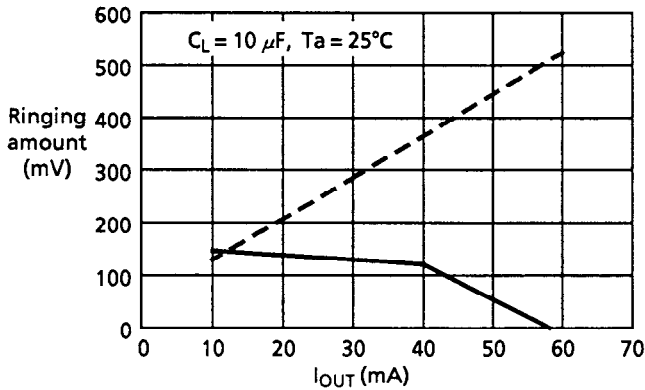

2.  $C_L$  dependency

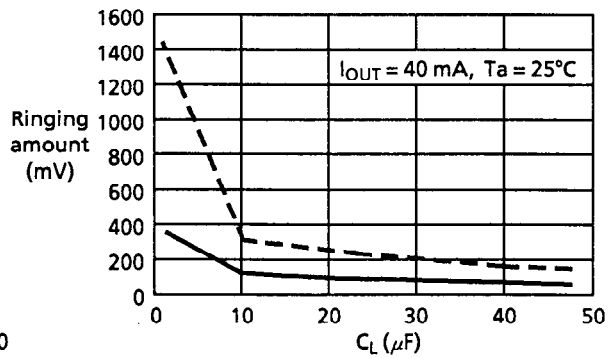

3.  $\Delta V_{IN}$  dependency

The lower voltage is fixed at  $(V_{OUT} + 1)$ .

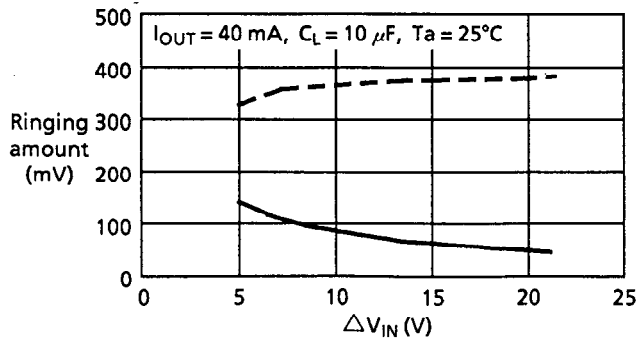

4. Temperature dependency

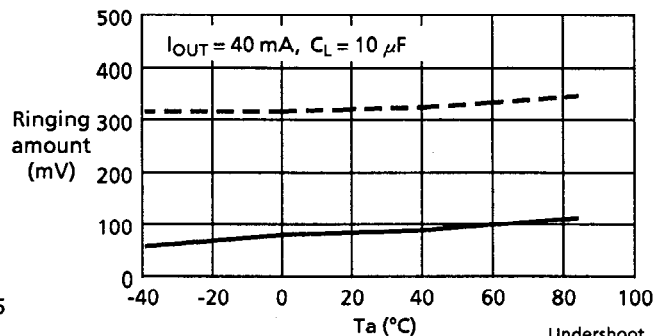

— Undershoot  
 - - - Overshoot

# HIGH WITHSTAND-VOLTAGE VOLTAGE REGULATOR WITH RESET FUNCTION

## S-87X Series

Reference data: Type II S-8750XXX series

1.  $I_{OUT}$  dependency

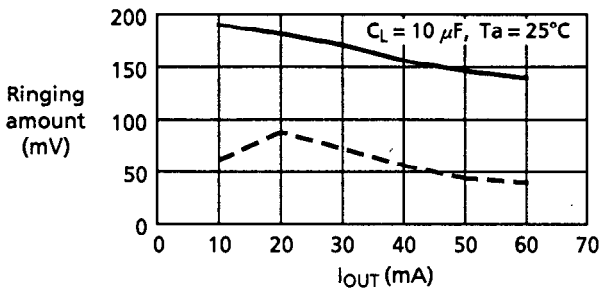

2.  $C_L$  dependency

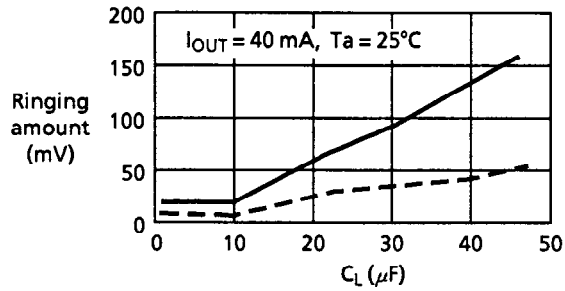

3.  $\Delta V_{IN}$  dependency  
The lower voltage is fixed at ( $V_{OUT} + 1$ ).

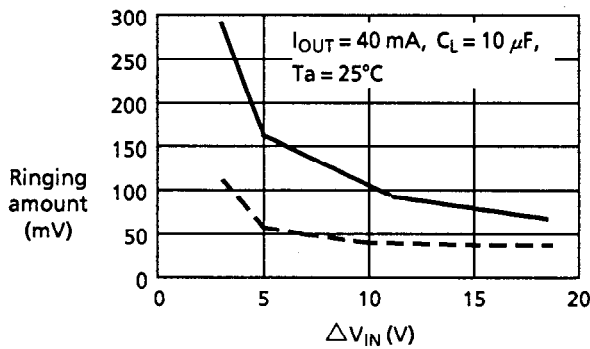

4. Temperature dependency

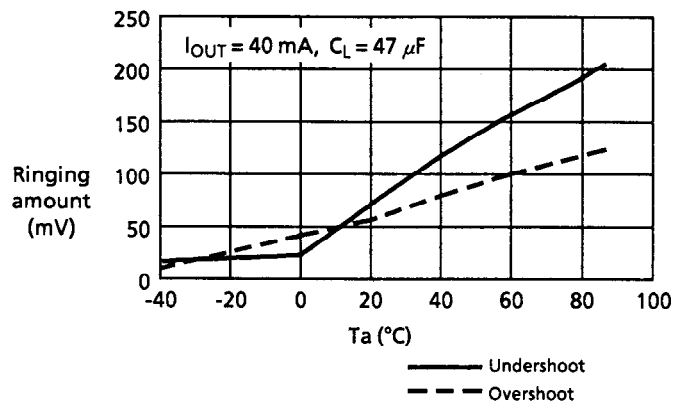

Reference data: Type II S-8730XXX series

1.  $I_{OUT}$  dependency

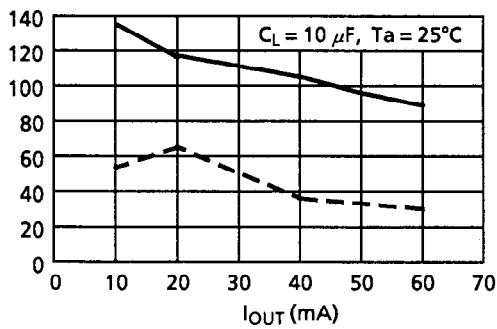

2.  $C_L$  dependency

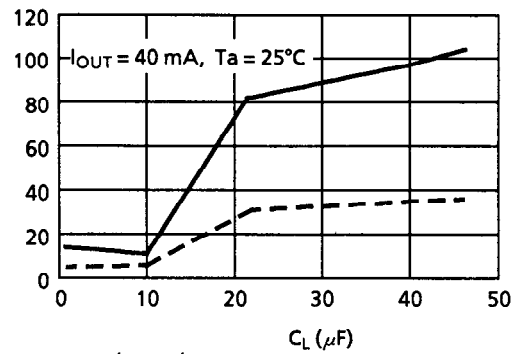

3.  $\Delta V_{IN}$  dependency  
The lower voltage is fixed at ( $V_{OUT} + 1$ ).

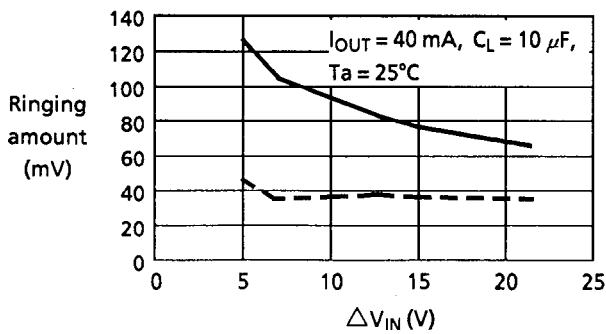

4. Temperature dependency

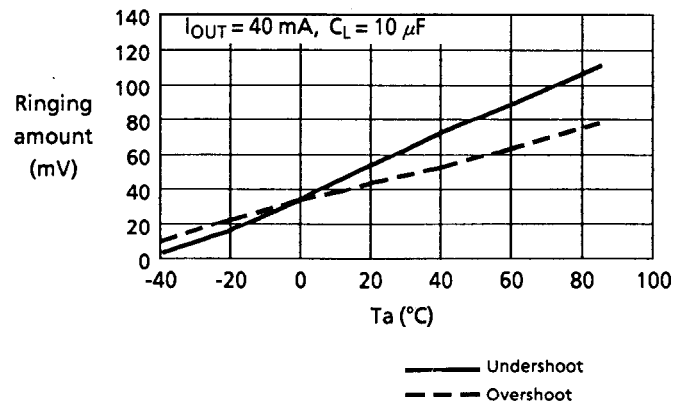

**2. Load transient response due to load current fluctuation**

An overshoot and an undershoot are caused in the output voltage if the load current is changed from 50  $\mu\text{A}$  to 40 mA while the input voltage is kept constant. Figure 18 shows the output voltage fluctuation due to a change in the load current. The measuring circuit is shown in Figure 19 for reference. The latter half of this section describes ringing waveform and parameter dependency.

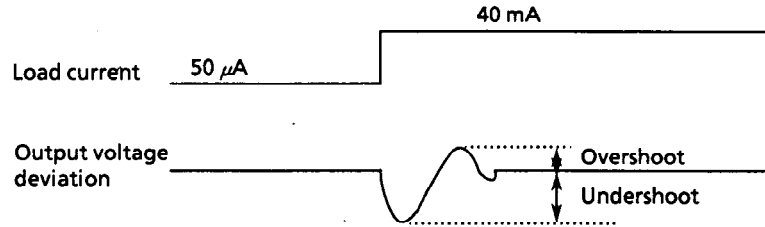

**Figure 18**

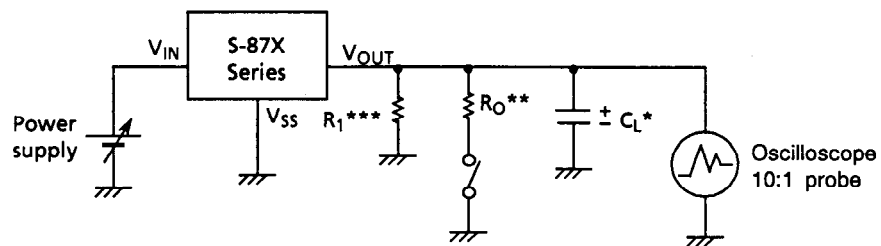

\* Al electrolytic capacitor

$$** R_0 = \frac{V_{OUT} [V]}{40 \text{ mA}} [\Omega]$$

$$*** R_1 = \frac{V_{OUT} [V]}{50 \mu\text{A}} [\Omega]$$

**Figure 19 Measuring circuit**

**Table 12 Parameter dependency due to load current fluctuation**

| Series                 | Parameter                     | Conditions                                        | Method to decrease overshoot | Method to decrease undershoot |
|------------------------|-------------------------------|---------------------------------------------------|------------------------------|-------------------------------|
| S-8750XXX<br>S-8730XXX | Load current $I_{OUT}$        | 10 to 60 mA, $C_L = 10 \mu\text{F}$               | Decrease                     | Decrease                      |
|                        | Load capacitance $C_L$        | 1 to 47 $\mu\text{F}$ , $I_{OUT} = 40 \text{ mA}$ | Increase                     | Increase                      |
|                        | Power supply voltage $V_{IN}$ | $(V_{OUT} + 1)$ to 24 V                           | Increase                     | Increase                      |
|                        | Temperature $T_a$             | -40°C to +85°C                                    | Low temperature              | Low temperature               |

# HIGH WITHSTAND-VOLTAGE VOLTAGE REGULATOR WITH RESET FUNCTION

## S-87X Series

### Reference data S-8750XXX Series

1.  $I_{OUT}$  dependency

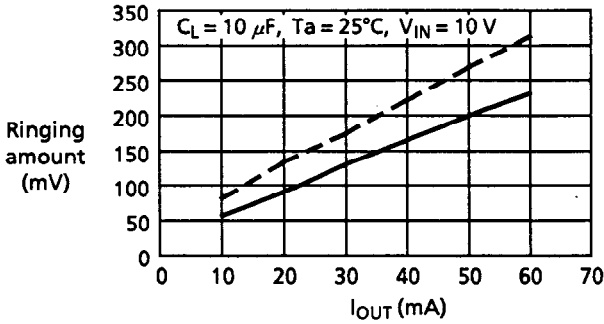

2.  $C_L$  dependency

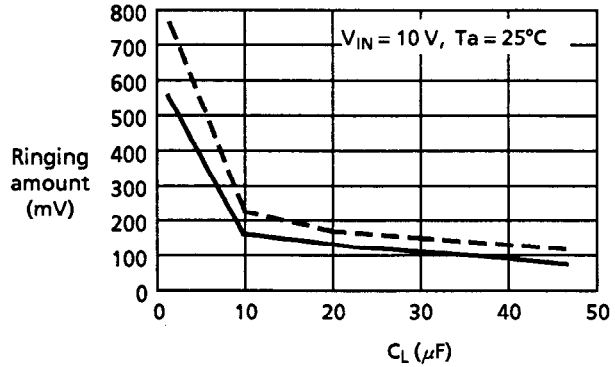

3.  $V_{IN}$  dependency

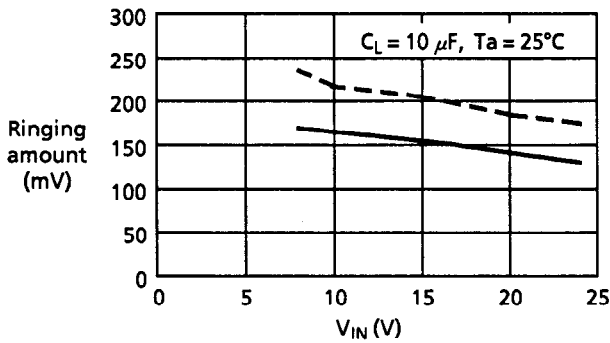

4. Temperature dependency

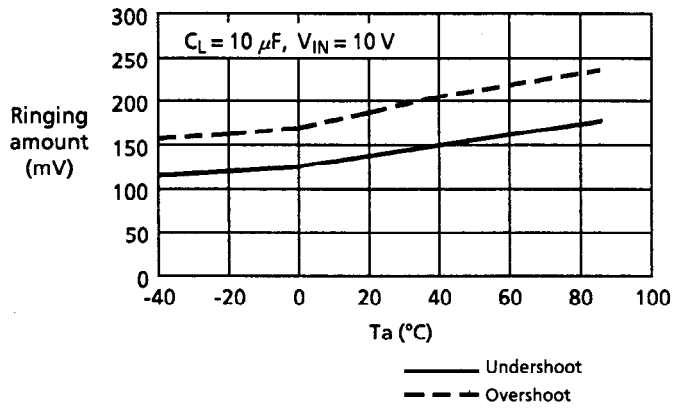

### Reference data S-8730XXX Series

1.  $I_{OUT}$  dependency

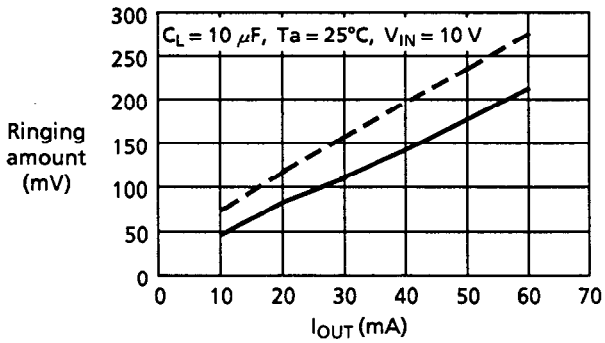

2.  $C_L$  dependency

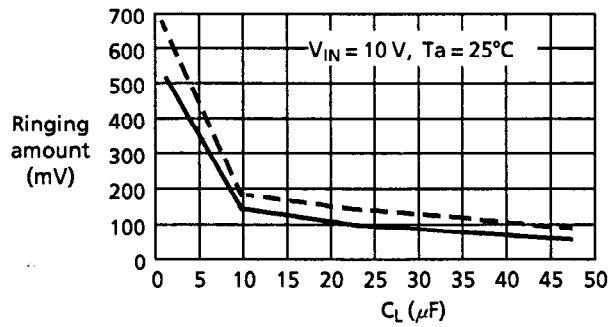

3.  $V_{IN}$  dependency

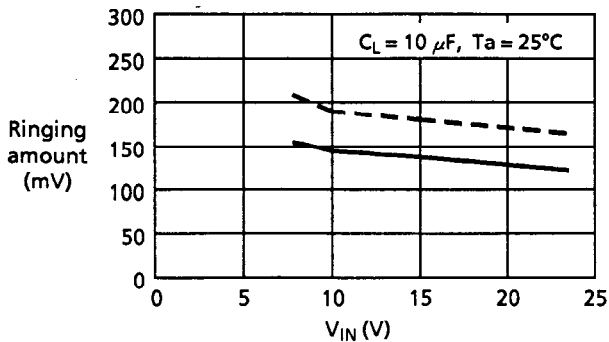

4. Temperature dependency

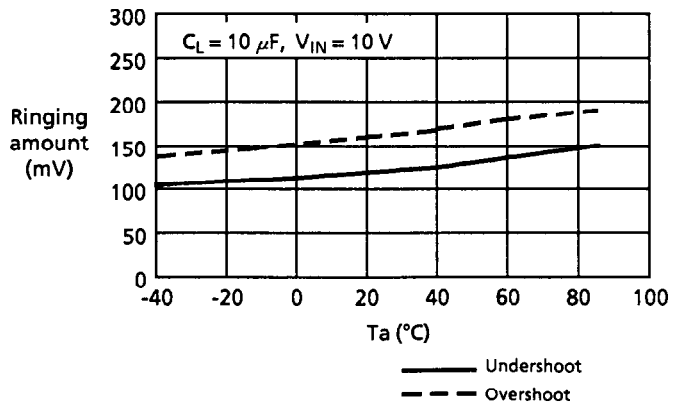

■ **Standard Circuits**

1. S-87XXXXA/B

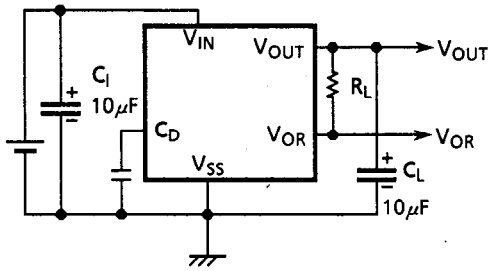

2. S-87XXXXC

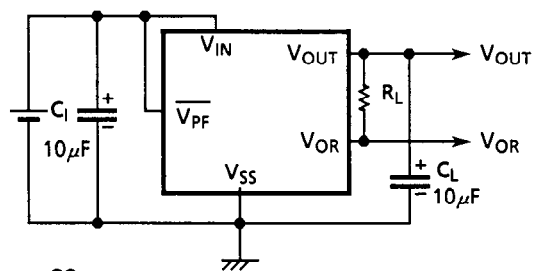

Figure 20

■ **Application Circuits**

1. Microcomputer power supply and reset circuit

To construct a microcomputer power supply and a reset circuit using conventional ICs, a voltage regulator IC, a voltage detector IC, a delay time generation circuit and others are required. The S-87XXXXA/B Series allows you to make these circuits without these ICs, and the delay time is variable.

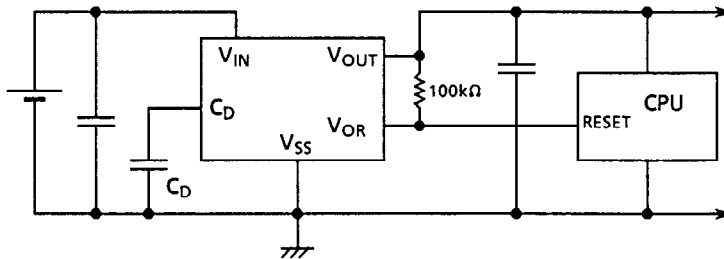
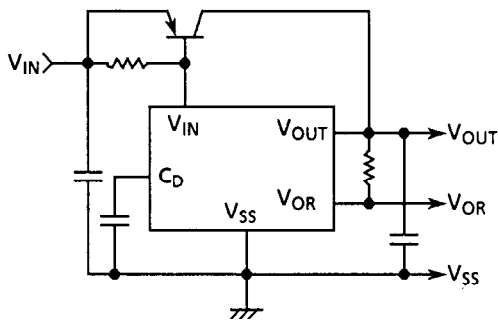

Figure 21

2. Circuit for increasing output current

A PNP transistor is used to increase the output current.

1. S-87XXXXA/B



2. S-87XXXXC

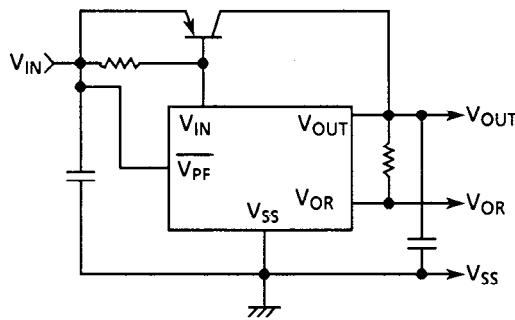

Figure 22

■ Notes

- Do not apply a ripple voltage of the conditions below to  $V_{IN}$  terminal.

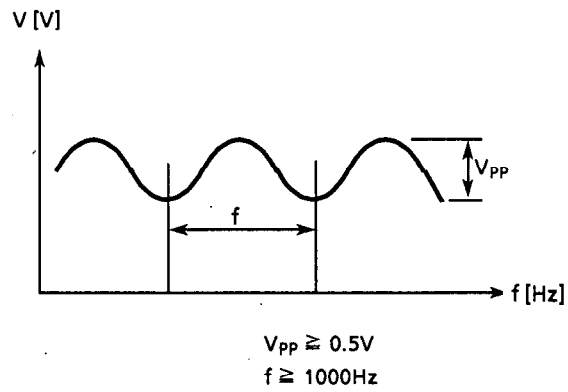

Figure 23

- When connecting the voltage regulator output terminal to another power supply, please insert a diode to protect the IC.

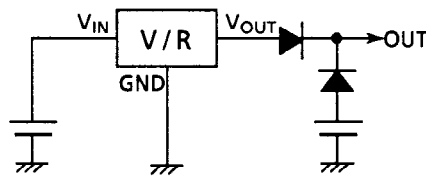
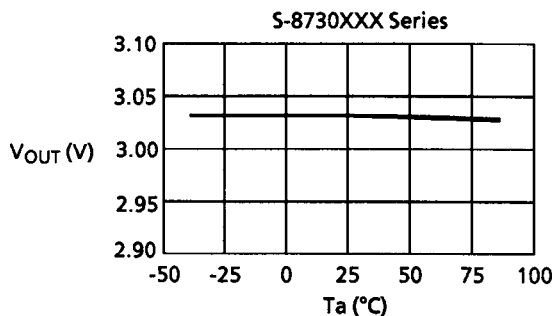
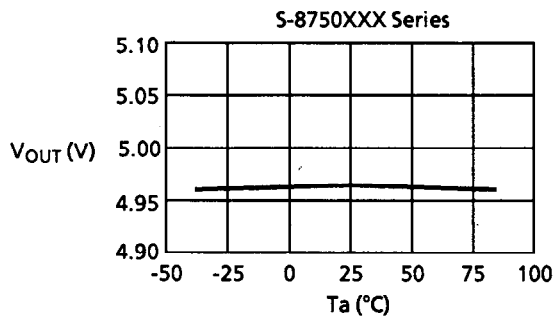

Figure 24

■ **Characteristics**

1. Voltage regulator

(1) Output voltage ( $V_{OUT}$ ) - Temperature ( $T_a$ )



(2) Line regulation - Temperature ( $T_a$ )

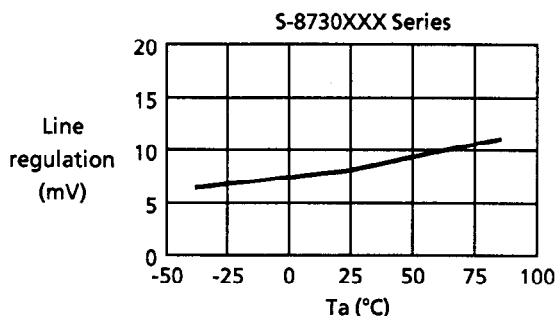
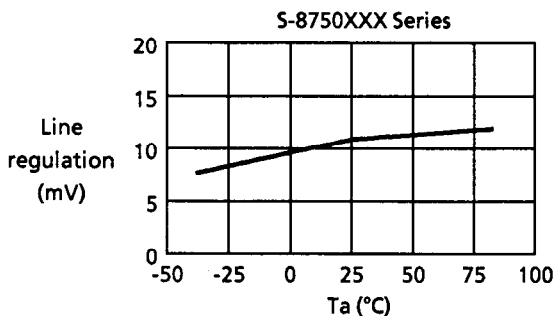

(3) Input voltage ( $V_{IN}$ ) - Output voltage ( $V_{OUT}$ )

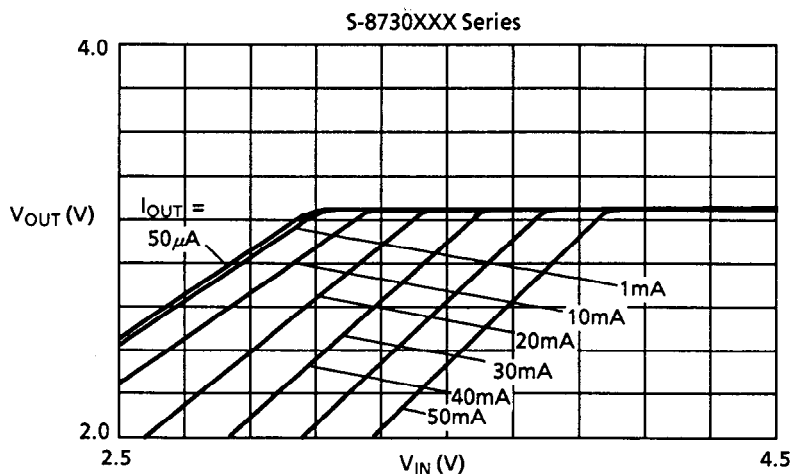
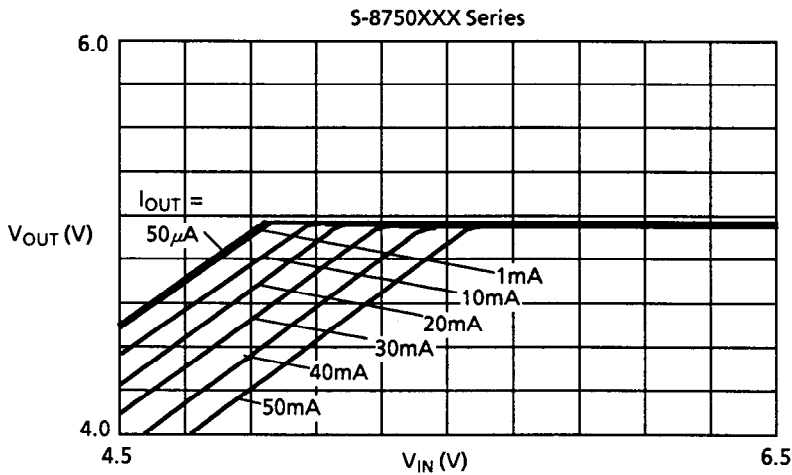



# HIGH WITHSTAND-VOLTAGE VOLTAGE REGULATOR WITH RESET FUNCTION

## S-87X Series

### (4) Load regulation – Temperature ( $T_a$ )

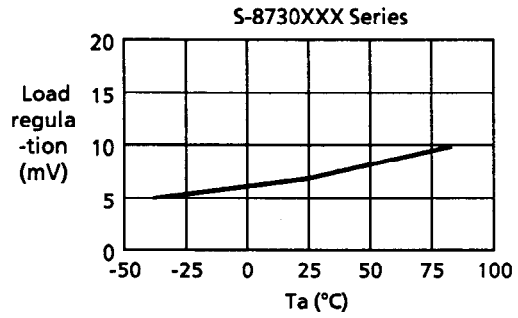
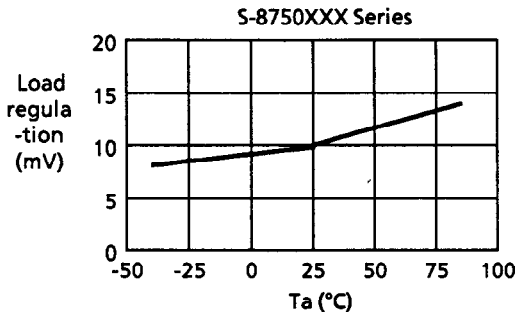

### (6) I/O voltage difference ( $V_{dif}$ ) – Temperature ( $T_a$ )

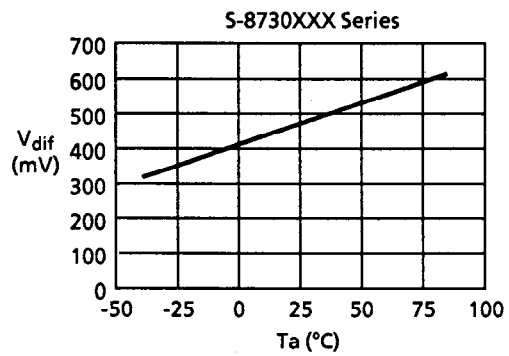
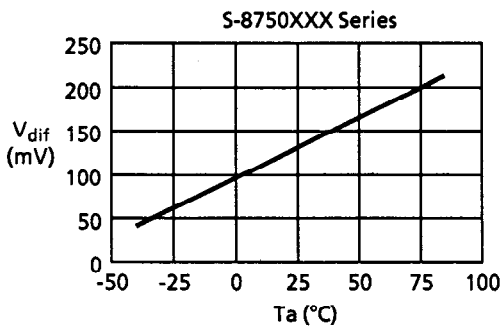

### (7) Short-circuit protection circuit

S-8750XXX Series  $T_a = 25^\circ\text{C}$

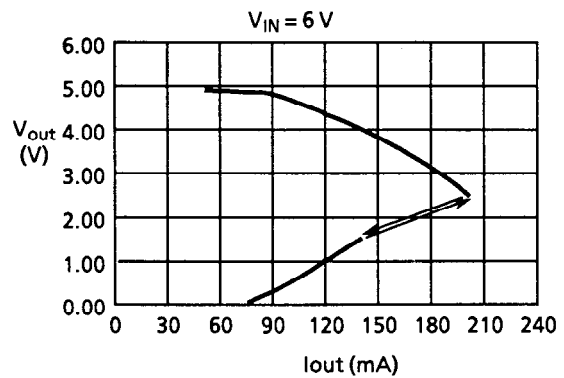
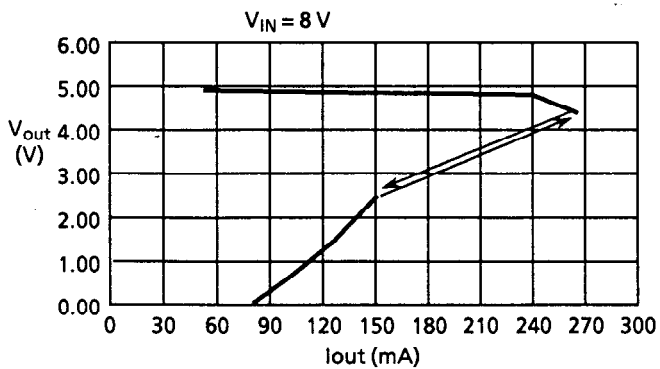
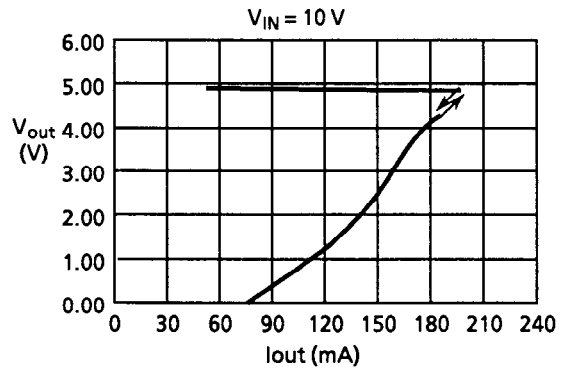
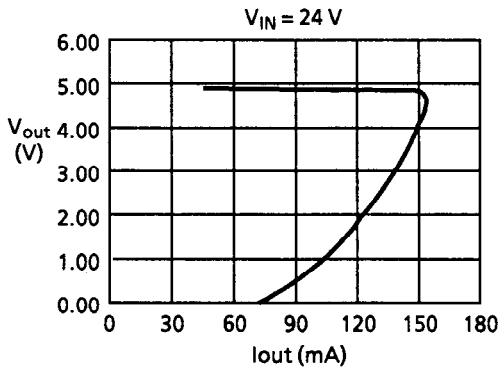

# HIGH WITHSTAND-VOLTAGE VOLTAGE REGULATOR WITH RESET FUNCTION

## S-87X Series

S-8730XXX Series       $T_a = 25^\circ\text{C}$

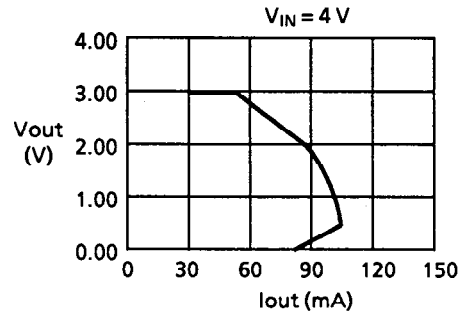
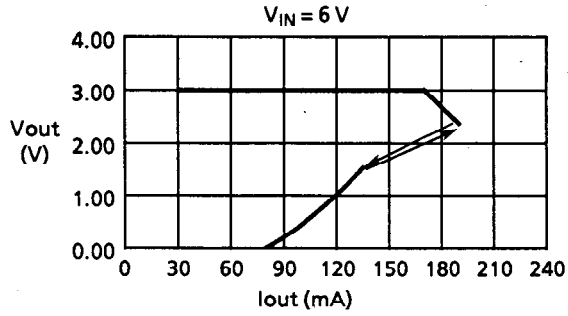
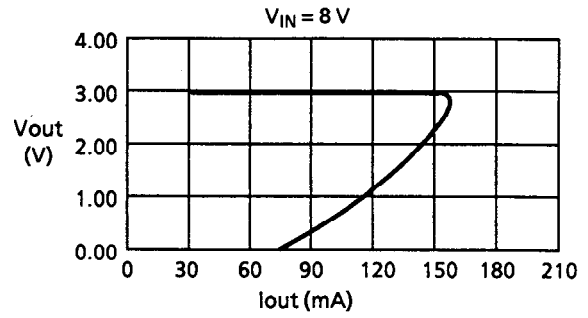
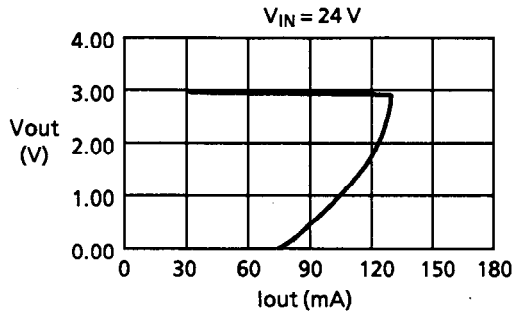

### (7) Ripple rejection

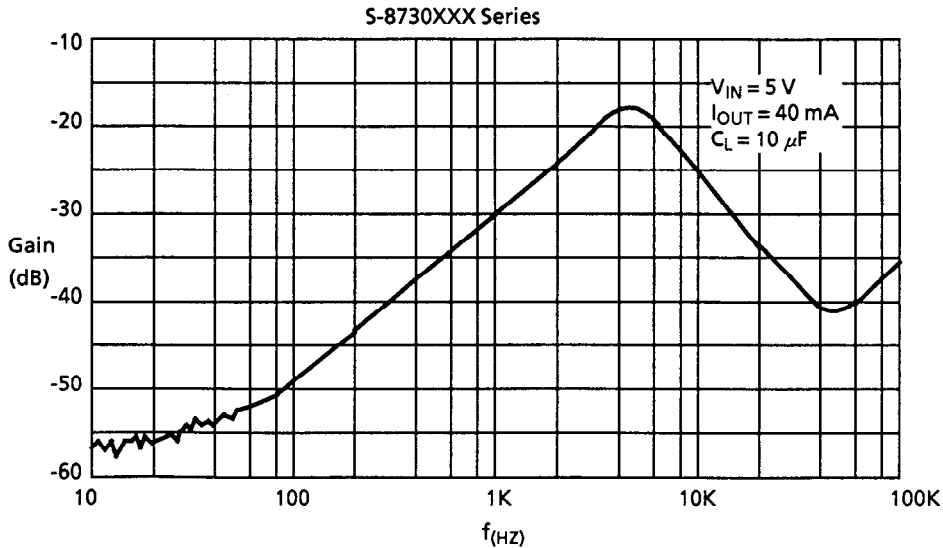
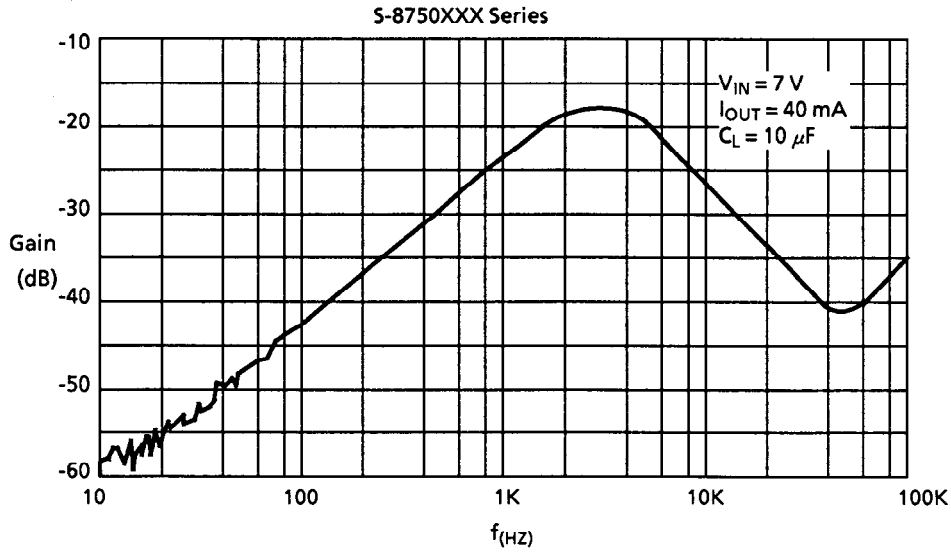

# HIGH WITHSTAND-VOLTAGE VOLTAGE REGULATOR WITH RESET FUNCTION

## S-87X Series

### 2. Voltage detector

#### (1) Detection voltage ( $V_{DET}$ ) - Temperature ( $T_a$ )

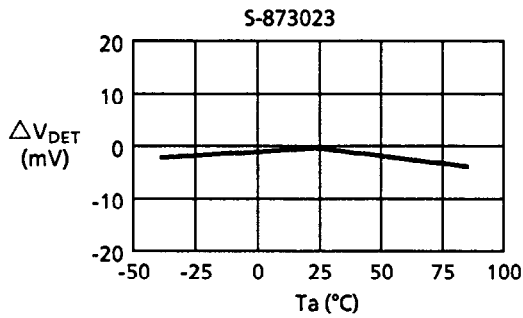
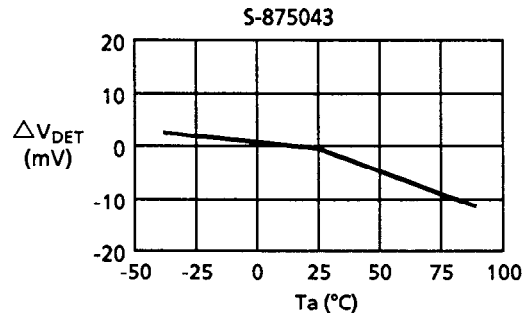
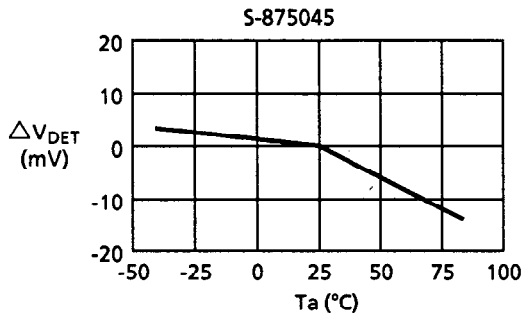

#### (2) Hysteresis width ( $V_{HYS}$ ) - Temperature ( $T_a$ )

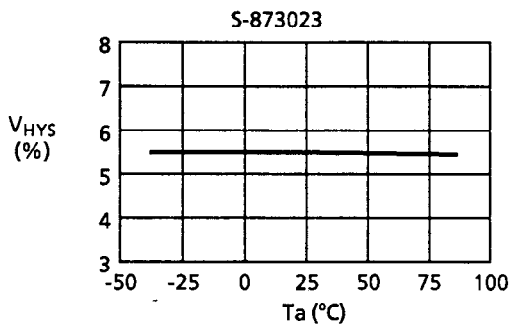
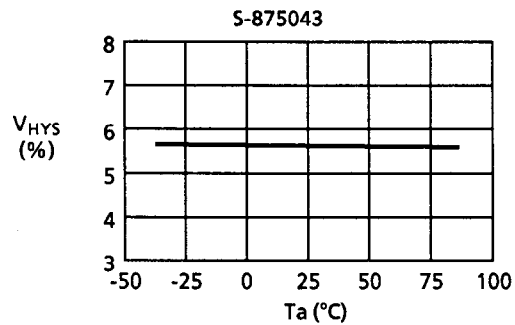
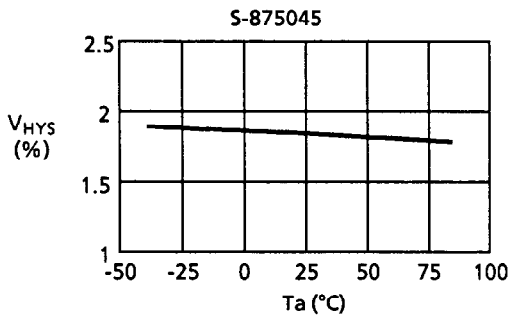

(3) Nch transistor output current ( $I_{dout}$ )

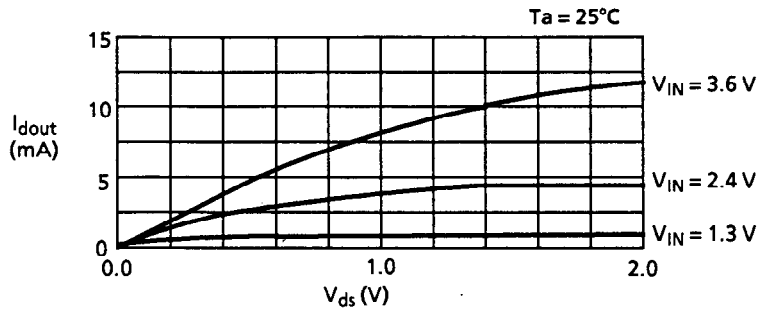

(4) Delay time ( $t_{pd}$ )

(a) Delay time ( $t_{pd}$ ) - Temperature ( $T_a$ )

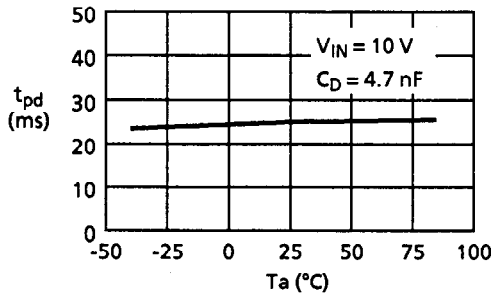

3. Total

(1) Current consumption ( $I_{ss}$ )

(a) Input voltage ( $V_{IN}$ )

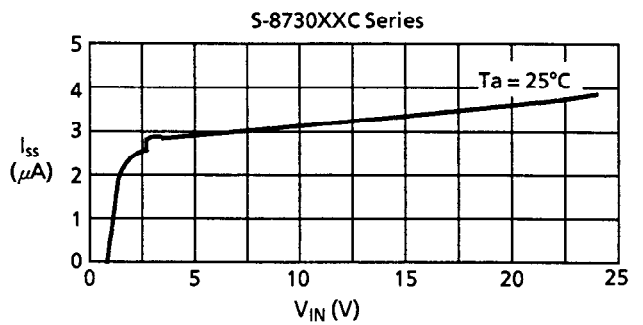
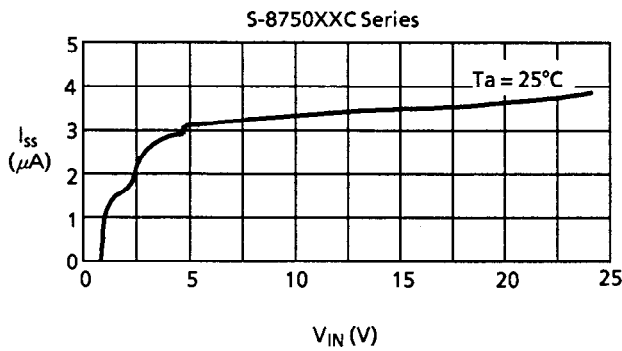

(b) Current consumption ( $I_{ss}$ ) - Temperature ( $T_a$ )

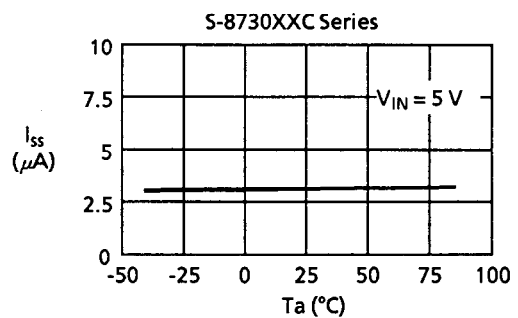
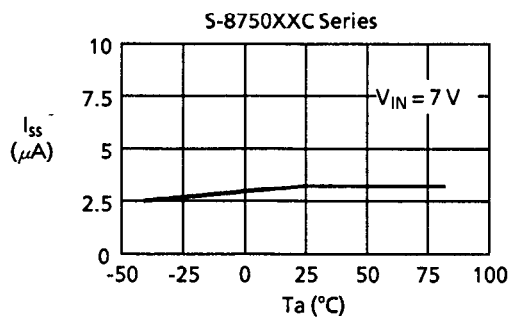

**HIGH WITHSTAND-VOLTAGE VOLTAGE REGULATOR WITH RESET FUNCTION**  
**S-87X Series**

(2) Input voltage of shutdown circuit

(a) High level input voltage ( $V_{IH}$ ) - Temperature ( $T_a$ )

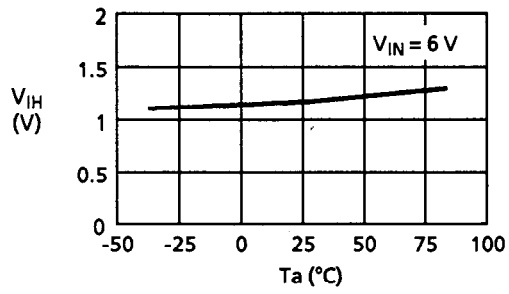

(b) Low level input voltage ( $V_{IL}$ ) - Temperature ( $T_a$ )

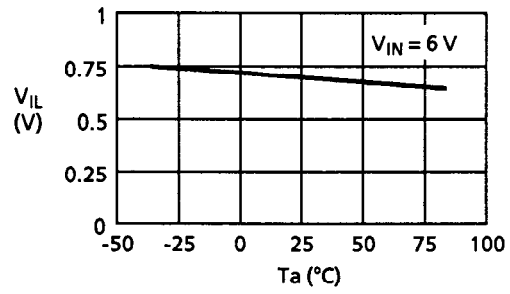

(c)  $V_{IH}$ ,  $V_{IL}$  - power supply voltage dependency

