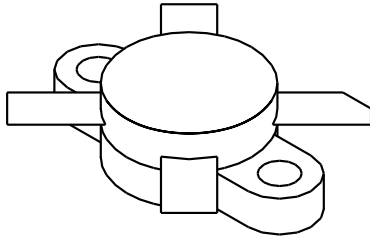

# S175 - 50

175 Watts, 50 Volts, Class AB  
Milcom 1.5 - 30 MHz

<p><b>GENERAL DESCRIPTION</b> The S175-50 is a 50 Volt, COMMON EMITTER device designed for Class A, AB or C operation in the HF/VHF frequency bands. Its high collector voltage simplifies the design of wideband, SSB linear amplifiers. The transistor chip is built using Gold Topside Metal, diffused emitter ballast resistors and silicon nitride passivation, providing the user with the Highest MTF available.</p>	<p><b>CASE OUTLINE</b> <b>55HX, Style 2</b></p> 
<p><b>ABSOLUTE MAXIMUM RATINGS</b></p> <p>Maximum Power Dissipation @ 25°C <span style="float: right;">270 Watts</span></p> <p><b>Maximum Voltage and Current</b></p> <p>BVces Collector to Emitter Voltage <span style="float: right;">110 Volts</span>          BVebo Emitter to Base Voltage <span style="float: right;">4.0 Volts</span>          Ic Collector Current <span style="float: right;">20 A</span></p> <p><b>Maximum Temperatures</b></p> <p>Storage Temperature <span style="float: right;">- 65 to +150°C</span>          Operating Junction Temperature <span style="float: right;">+200°C</span></p>	

**ELECTRICAL CHARACTERISTICS @ 25 °C**

SYMBOL	CHARACTERISTICS	TEST CONDITIONS	MIN	TYP	MAX	UNITS
<b>Pout</b>	Power Output	F = 30 MHz	175			Watts
<b>Pin</b>	Power Input	Vcc = 50 Volts			3.5	Watts
<b>Pg</b>	Power Gain	At Rated Power Out	17	17.5		dB
$\eta_c$	Efficiency			65		%
<b>VSWR</b>	Load Mismatch Tolerance				30:1	

<b>BVebo</b>	Emitter to Base Breakdown	Ie = 10 mA	4			Volts
<b>BVces</b>	Collector to Emitter	Ic = 100 mA	110			Volts
<b>BVceo</b>	Breakdown	Ie = 100 mA	53			Volts
<b>Zin</b>	Collector to Emitter	At Rated Pout & Freq.		0.6-j0.4		OHMS
<b>ZI</b>	Breakdown	At Rated Pout & Freq.		4.6+2.1		OHMS
<b>Cob</b>	Series Input Impedance	Vcb = 50 V, Ie = 0		180		
<b>hFE</b>	Series Load Impedance	Vce = 5 V, Ic = 2 A	10			
<b>IMD</b>	Output Capacitance	At Rated Pout		-35		dBc
	DC - Current Gain					
	Intermodulation Distortion Lev.					

Initial Issue June, 1994

GHz TECHNOLOGY INC. RESERVES THE RIGHT TO MAKE CHANGES WITHOUT FURTHER NOTICE. GHz RECOMMENDS THAT BEFORE THE PRODUCT(S) DESCRIBED HEREIN ARE WRITTEN INTO SPECIFICATIONS, OR USED IN CRITICAL APPLICATIONS, THAT THE PERFORMANCE CHARACTERISTICS BE VERIFIED BY CONTACTING THE FACTORY.



**GHz TECHNOLOGY**  
RF·MICROWAVE SILICON POWER TRANSISTORS

*S175-50*

**DC SAFE OPERATING AREA**

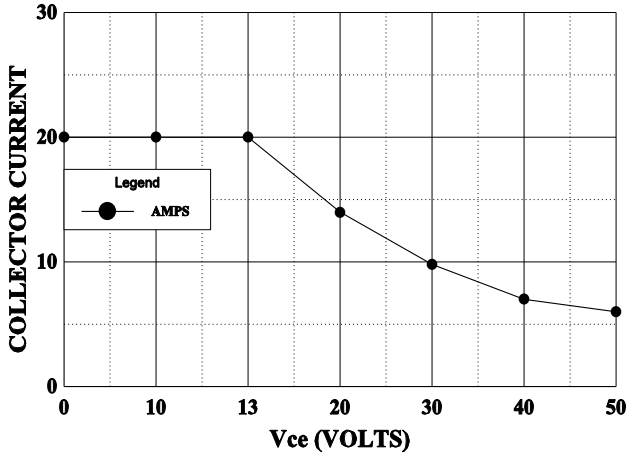

**POWER OUTPUT vs POWER INPUT**

Vcc = 50V, Frequency 30MHz

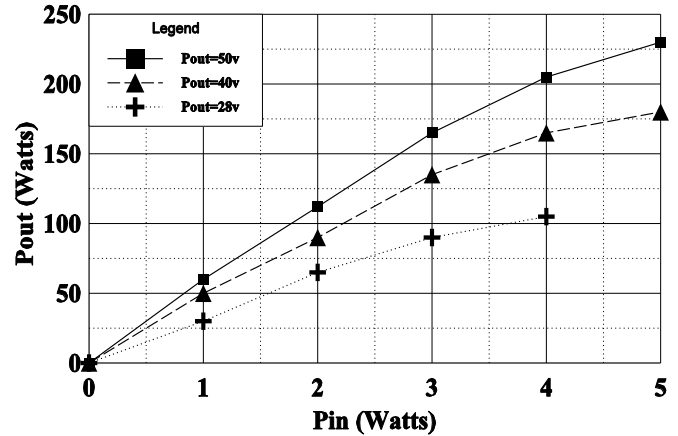

**SERIES INPUT IMPEDANCE vs FREQUENCY**

Vcc = 50V, Pin = W

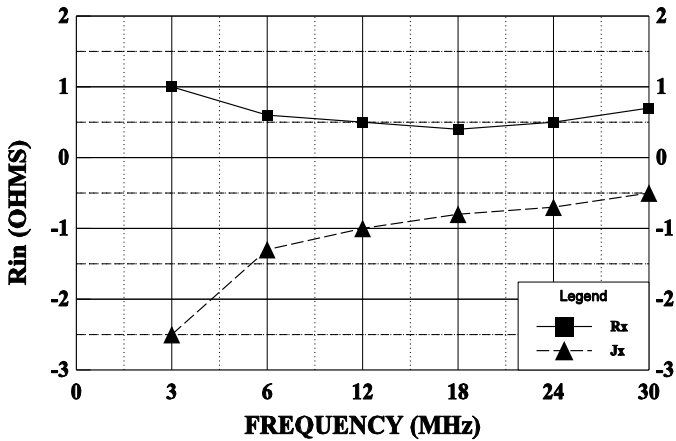

**COLLECTOR CUR. vs BASE EMITTER VOLTAGE**

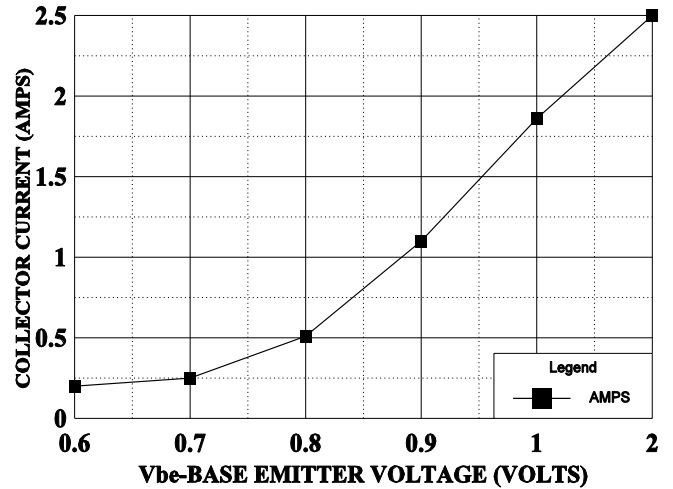

**CUTOFF FREQUENCY vs COLLECTOR CURRENT**

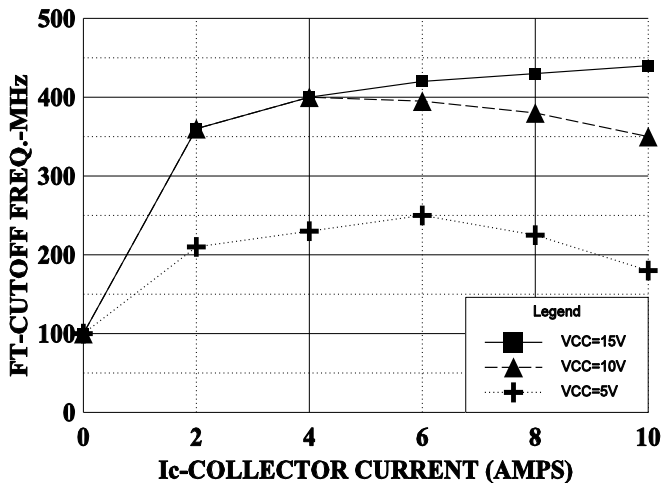

**3RD ORDER IMD vs Pout**

Vcc = 50V, Pin = W

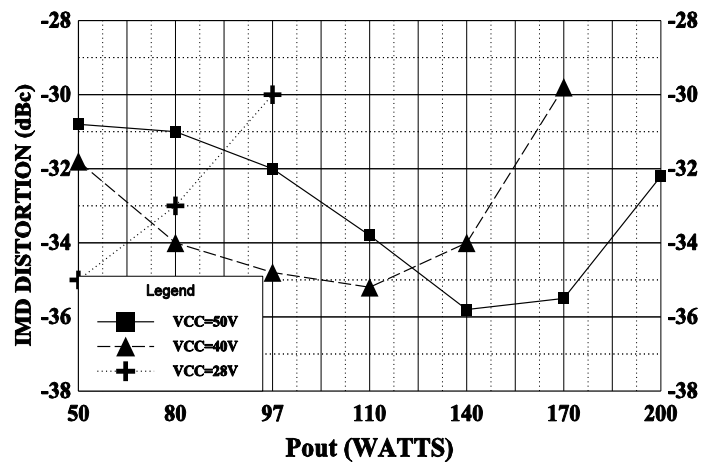

2-30 MHz, 300 Watts  
Linear Amplifier

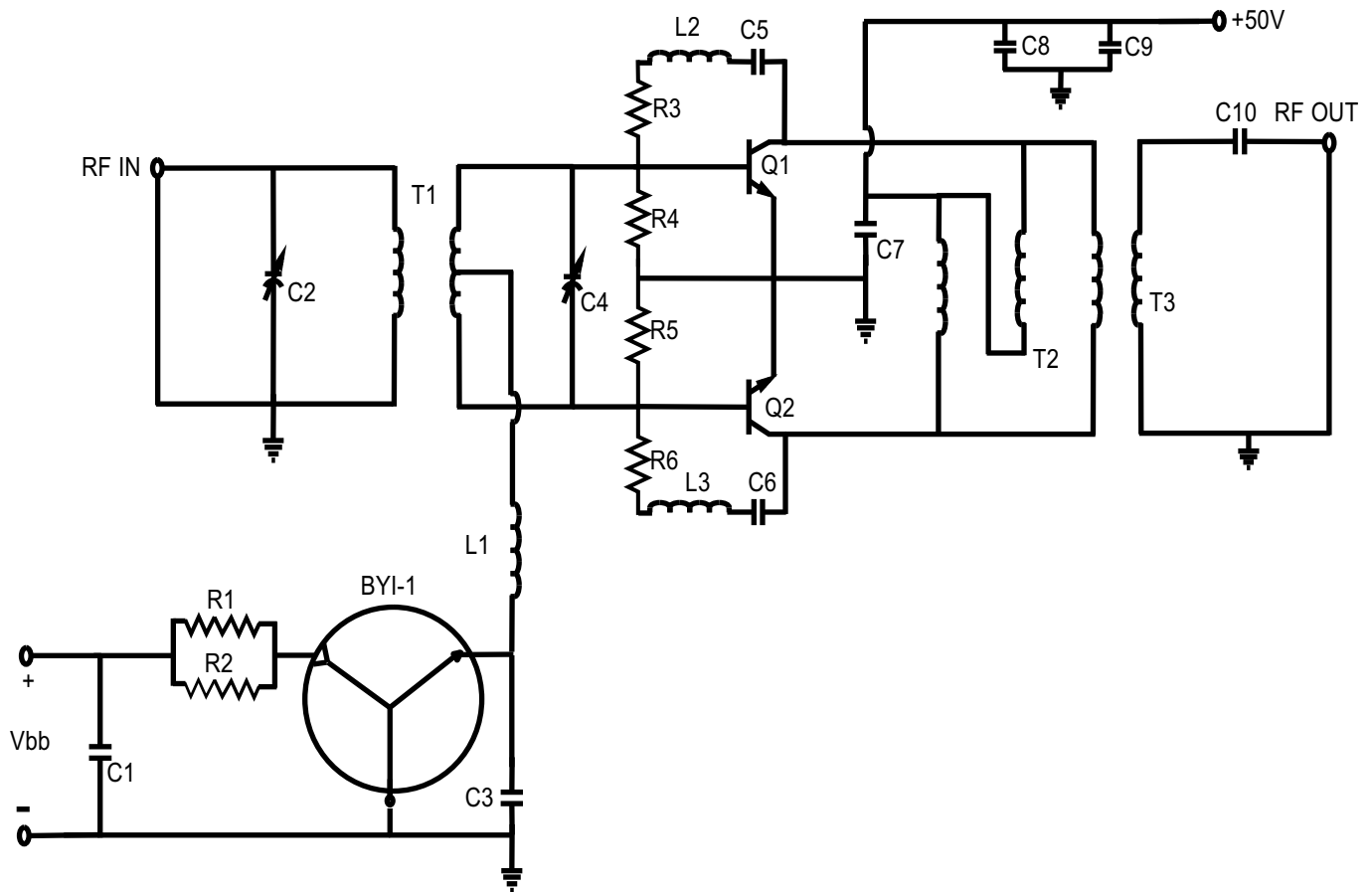

Q1,Q2=Ghz S175-50  
 BYISTOR=GHz BYI-1  
 C1,C3,C5,C6,C7,C8=0.1mF ceramic  
 C2=25-240pF Compression Mica  
 C4=75-480pF Compression Mica  
 C9=10mF, 50V, Electrolytic  
 C10=2700pF DM15  
 L1=6 turns on Indiana General F627-9, H Material  
 L2,L3=2.2mH, Molded Inductor  
 R1,R2=22W, 2 Watts  
 R3,R6=220W, 2 Watts  
 R4,R5=10W, 1/4 Watt

### TRANSFORMER DETAILS

T1: 8 beads of Indiana General F625-9, H material on two brass tubes. The primary is four turns of #20 vinyl clad wire wound through the brass tubes

T2: #20 twisted pair, approximately 2 crests per centimeter, wound on Indiana General F624-19, H material

T3: 10 beads of Indiana General F627-8, H material mounted on two brass tubes. The secondary consist of 3 #20 vinyl clad wires in parallel. The three wires should be wound to produce a 2:1 turns ratio