

# S200R Series

2W, Low Cost DIP, Single & Dual Output DC/DC Converters

## Key Features

- Low Cost
- 500VDC Isolation
- MTBF > 800,000 Hours
- 40mV P-P Ripple and Noise
- Input 5, 12, 24 and 48VDC
- Output 5, 12, 15,  $\pm 12$  and  $\pm 15$ VDC
- Temperature Performance  $-25^{\circ}\text{C}$  to  $+71^{\circ}\text{C}$
- Short Circuit Protection
- UL 94V-0 Package Material
- Internal SMD Construction



Minimax's S200R Model 2W DC/DC's are specially designed to provide 40mA output ripple, continuous short circuit in a low-profile 24-pin DIP package.

The series consists of 20 models with input voltages of 5V, 12V, 24V and 48VDC which offers regulated output voltages of 5V, 12V, 15V,  $\pm 12$ V and  $\pm 15$ VDC.

The  $-25^{\circ}\text{C}$  to  $+71^{\circ}\text{C}$  operating temperature range makes it ideal for data communication equipments, mobile battery driven equipments, distributed power systems, telecommunication equipments, mixed analog/digital subsystems, automatic test instrumentation and industrial robot systems.

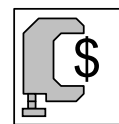

Low Cost

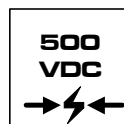

I/O Isolation

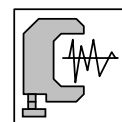

Low Noise

## Block Diagram

### Single Output

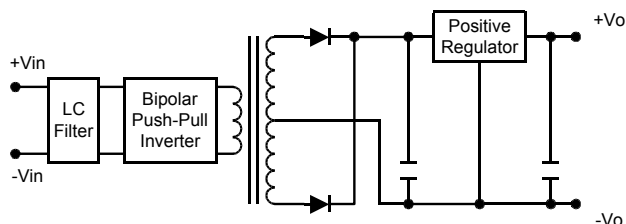

### Dual Output

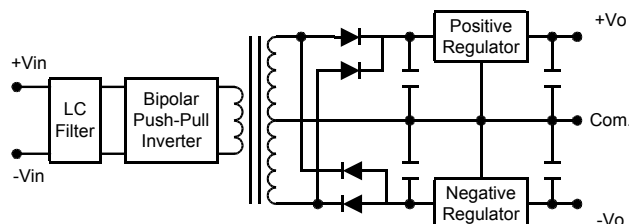

## Model Selection Guide

Model Number	Input Voltage	Output Voltage	Output Current		Input Current		Reflected Ripple Current	Efficiency
			Max.	Min.	@Max. Load	@No Load		@Max. Load
	VDC	VDC	mA	mA	mA (Typ.)	mA (Typ.)	mA (Typ.)	% (Typ.)
S201R	5 (4.5 ~ 5.5)	5	400	0	800	80	80	50
S202R		12	165		730			54
S203R		15	133		690			57
S204R		±12	±83		740			53
S205R		±15	±66		770			51
S206R	12 (10.8 ~ 13.2)	5	400	0	330	40	30	50
S207R		12	165		295			56
S208R		15	133		265			62
S209R		±12	±83		280			59
S210R		±15	±66		280			59
S211R	24 (21.6 ~ 26.4)	5	400	0	163	20	15	51
S212R		12	165		135			61
S213R		15	133		135			61
S214R		±12	±83		135			61
S215R		±15	±66		135			61
S216R	48 (43.2 ~ 52.8)	5	400	0	83	10	10	50
S217R		12	165		70			59
S218R		15	133		70			59
S219R		±12	±83		80			51
S220R		±15	±66		80			51

## Absolute Maximum Ratings

Parameter	Min.	Max.	Unit	
Input Surge Voltage (1000 mS)	5VDC Input Models	-0.7	7.5	VDC
	12VDC Input Models	-0.7	15	VDC
	24VDC Input Models	-0.7	30	VDC
	48VDC Input Models	-0.7	55	VDC
Lead Temperature (1.5mm from case for 10 Sec.)	---	260	°C	
Internal Power Dissipation	---	3,000	mW	

Exceeding the absolute maximum ratings of the unit could cause damage. These are not continuous operating ratings.

## Notes :

- Specifications typical at Ta=+25°C, resistive load, nominal input voltage, rated output current unless otherwise noted.
- Transient recovery time is measured to within 1% error band for a step change in output load of 50% to 100%.
- Ripple & Noise measurement bandwidth is 0-20 MHz.
- All DC/DC converters should be externally fused at the front end for protection.
- Other input and output voltage may be available, please contact factory.
- Specifications subject to change without notice.

## Environmental Specifications

Parameter	Conditions	Min.	Max.	Unit
Operating Temperature	Ambient	-25	+71	°C
Operating Temperature	Case	-25	+90	°C
Storage Temperature		-40	+125	°C
Humidity		---	95	%
Cooling	Free-Air Convection			

## Input Specifications

Parameter	Model	Min.	Typ.	Max.	Unit
Input Voltage Range	5V Input Models	4.5	5	5.5	VDC
	12V Input Models	10.8	12	13.2	
	24V Input Models	21.6	24	26.4	
	48V Input Models	43.2	48	52.8	
Reverse Polarity Input Current	All Models	---	---	0.5	A
Short Circuit Input Power		---	---	2000	mW
Input Filter		Pi Filter			

## Output Specifications

Parameter	Conditions	Min.	Typ.	Max.	Unit
Output Voltage Accuracy		---	±2.0	±4.0	%
Output Voltage Balance	Dual Output, Balanced Loads	---	±1.0	±3.0	%
Line Regulation	Vin=Min. to Max.	---	±0.2	±0.5	%
Load Regulation	Io=10% to 100%	---	±0.2	±0.5	%
Ripple & Noise (20MHz)		---	40	50	mV P-P
Ripple & Noise (20MHz)	Over Line, Load & Temp.	---	---	75	mV P-P
Ripple & Noise (20MHz)		---	---	5	mV rms
Over Load		120	---	---	%
Transient Recovery Time	50% Load Step Change	---	---	50	uS
Transient Response Deviation		---	---	±6	%
Temperature Coefficient		---	±0.01	±0.02	%/°C
Output Short Circuit	Continuous				

## General Specifications

Parameter	Conditions	Min.	Typ.	Max.	Unit
Isolation Voltage Rated	60 Seconds	500	---	---	VDC
Isolation Test Voltage	Flash Tested for 1 Second	550	---	---	VDC
Isolation Resistance	500VDC	1000	---	---	MΩ
Isolation Capacitance	100KHz, 1V	---	100	150	pF
Switching Frequency		40	80	---	KHz
MTBF	MIL-HDBK-217F @ 25°C, Ground Benign	800	---	---	K Hours

## Capacitive Load

Models by Vout	5V	12V	15V	±12V #	±15V #	Unit
Maximum Capacitive Load	470	470	470	220	220	uF

# For each output

## Input Fuse Selection Guide

5V Input Models	12V Input Models	24V Input Models	48V Input Models
1500mA Slow – Blow Type	700mA Slow – Blow Type	350mA Slow – Blow Type	135mA Slow – Blow Type

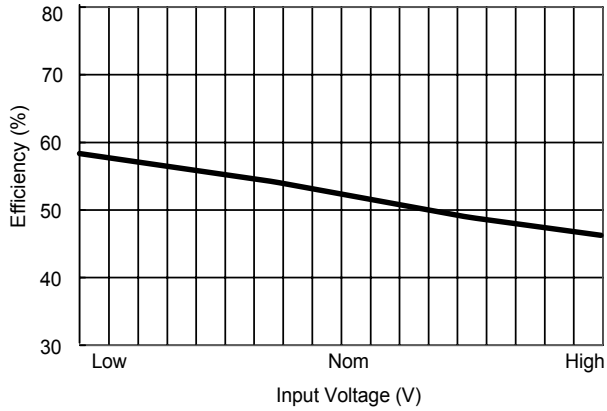

**Efficiency vs Input Voltage ( Single Output )**

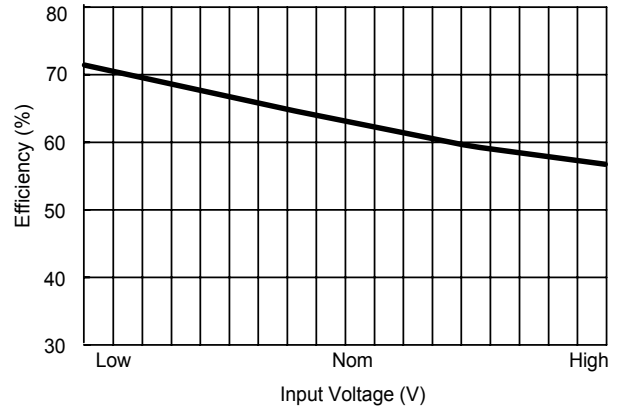

**Efficiency vs Input Voltage ( Dual Output )**

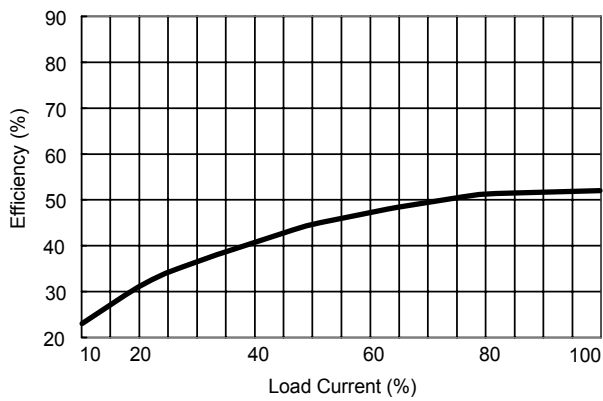

**Efficiency vs Output Load ( Single Output )**

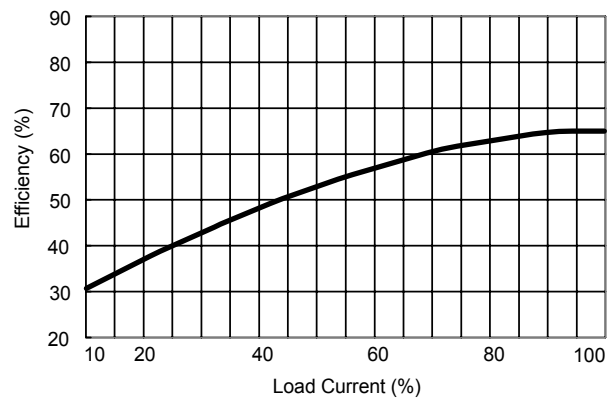

**Efficiency vs Output Load ( Dual Output )**

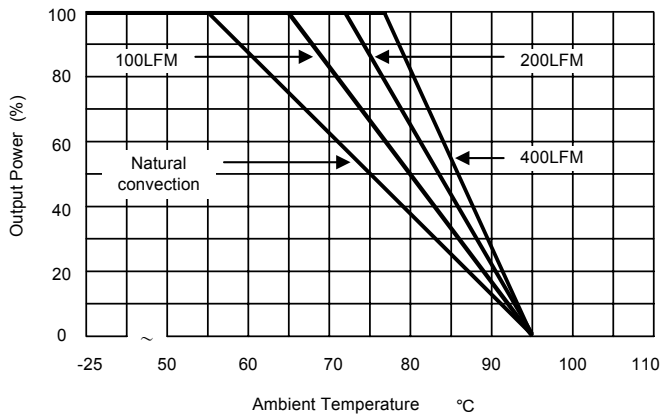

**Derating Curve ( 5V output only )**

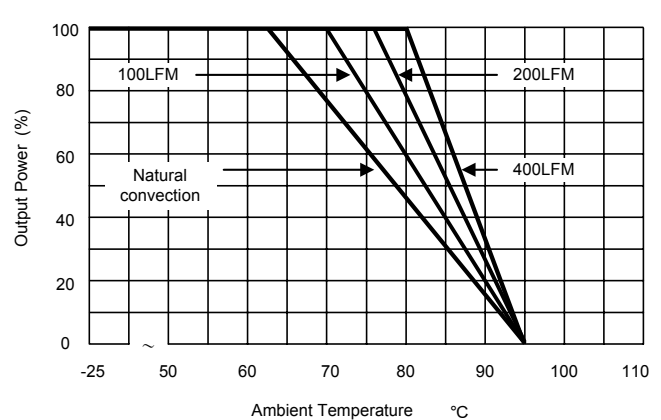

**Derating Curve ( all other output )**

## Test Configurations

### Input Reflected-Ripple Current Test Setup

Input reflected-ripple current is measured with an inductor  $L_{in}$  (4.7uH) and  $C_{in}$  (220uF, ESR < 1.0Ω at 100 KHz) to simulate source impedance.

Capacitor  $C_{in}$ , offsets possible battery impedance.

Current ripple is measured at the input terminals of the module, measurement bandwidth is 0–500 KHz.

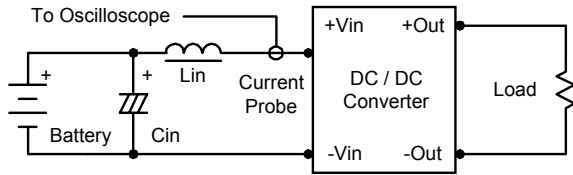

In applications where power is supplied over long lines and output loading is high, it may be necessary to use a capacitor at the input to ensure startup.

Capacitor mounted close to the power module helps ensure stability of the unit, it is recommended to use a good quality low Equivalent Series Resistance (ESR < 1.0Ω at 100 KHz) capacitor of a 2.2uF for the 5V input devices, a 1.0uF for the 12V input devices and a 0.47uF for the 24V and 48V devices.

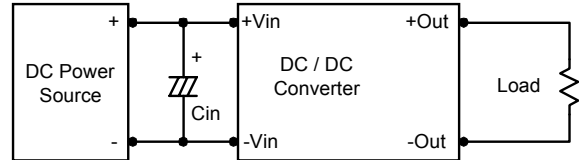

### Peak-to-Peak Output Noise Measurement Test

Use a  $C_{out}$  0.33uF ceramic capacitor.

Scope measurement should be made by using a BNC socket, measurement bandwidth is 0–20 MHz. Position the load between 50 mm and 75 mm from the DC/DC Converter.

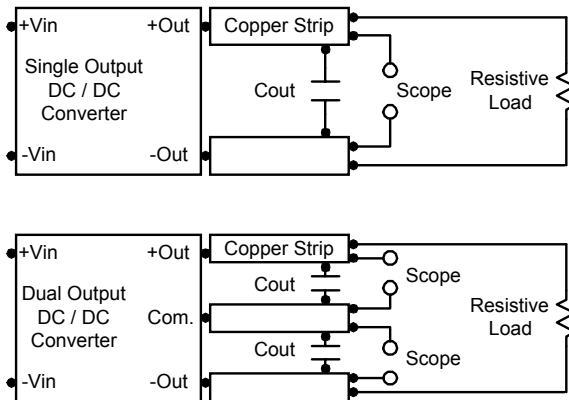

### Output Ripple Reduction

A good quality low ESR capacitor placed as close as practicable across the load will give the best ripple and noise performance.

To reduce output ripple, it is recommended to use 1.5uF capacitors at the output.

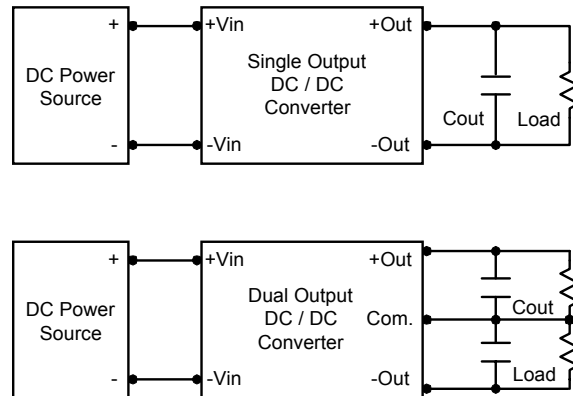

## Design & Feature Considerations

### Maximum Capacitive Load

The S200R series has limitation of maximum connected capacitance at the output.

The power module may be operated in current limiting mode during start-up, affecting the ramp-up and the startup time.

For optimum performance we recommend 220uF maximum capacitive load for dual outputs and 470uF capacitive load for single outputs.

The maximum capacitance can be found in the data sheet.

### Input Source Impedance

The power module should be connected to a low ac-impedance input source. Highly inductive source impedances can affect the stability of the power module.

### Thermal Considerations

Many conditions affect the thermal performance of the power module, such as orientation, airflow over the module and board spacing. To avoid exceeding the maximum temperature rating of the components inside the power module, the case temperature must be kept below 90°C.

The derating curves are determined from measurements obtained in an experimental apparatus.

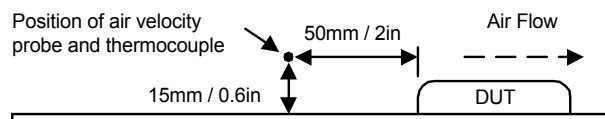

## Mechanical Dimensions

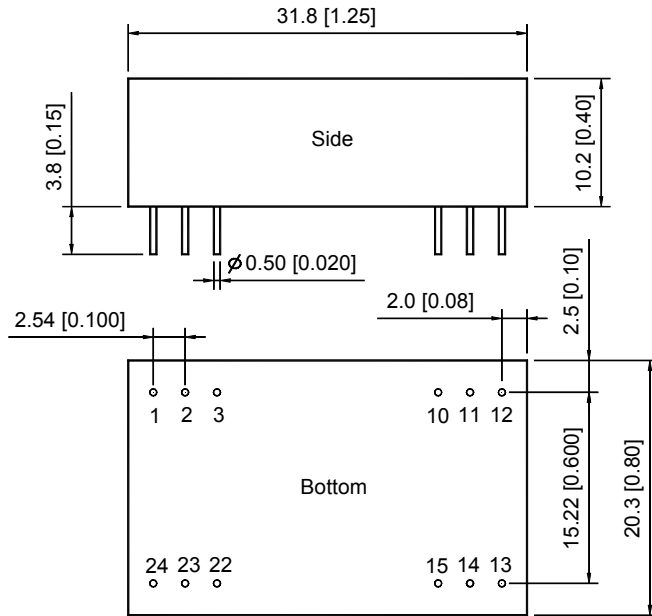

Tolerance	Millimeters	Inches
	X.X±0.25	X.XX±0.01
	X.XX±0.13	X.XXX±0.005
Pin	±0.05	±0.002

## Connecting Pin Patterns

Top View ( 2.54 mm / 0.1 inch grids )

### Single Output

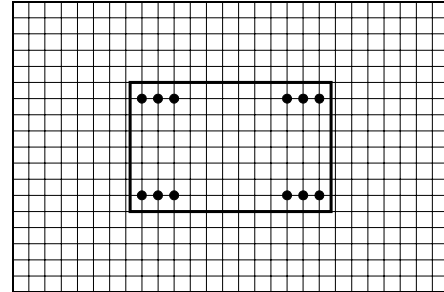

### Dual Output

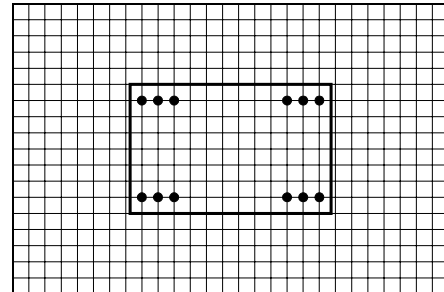

## Pin Connections

Pin	Single Output	Dual Output
1	+Vin	+Vin
2	NC	-Vout
3	NC	Common
10	-Vout	Common
11	+Vout	+Vout
12	-Vin	-Vin
13	-Vin	-Vin
14	+Vout	+Vout
15	-Vout	Common
22	NC	Common
23	NC	-Vout
24	+Vin	+Vin

NC: No Connection

## Physical Characteristics

**Case Size** : 31.8×20.3×10.2 mm  
1.25×0.80×0.40 inches

**Case Material** : Non-Conductive Black Plastic

**Weight** : 12.1g

**Flammability** : UL94V-0

The S200R converter is encapsulated in a low thermal resistance molding compound that has excellent resistance/electrical characteristics over a wide temperature range or in high humidity environments. The encapsulant and unit case are both rated to UL 94V-0 flammability specifications. Leads are tin plated for improved solderability.