

# SHINDENGEN

## Super Fast Recovery Rectifiers

Single

# S20L60

600V 20A

### FEATURES

- High Voltage
- trr100ns
- Small jc

### APPLICATION

- PFC
- Switching power supply
- Free Wheel
- Home Appliances, Office Equipment,
- Factory Automation

### OUTLINE DIMENSIONS

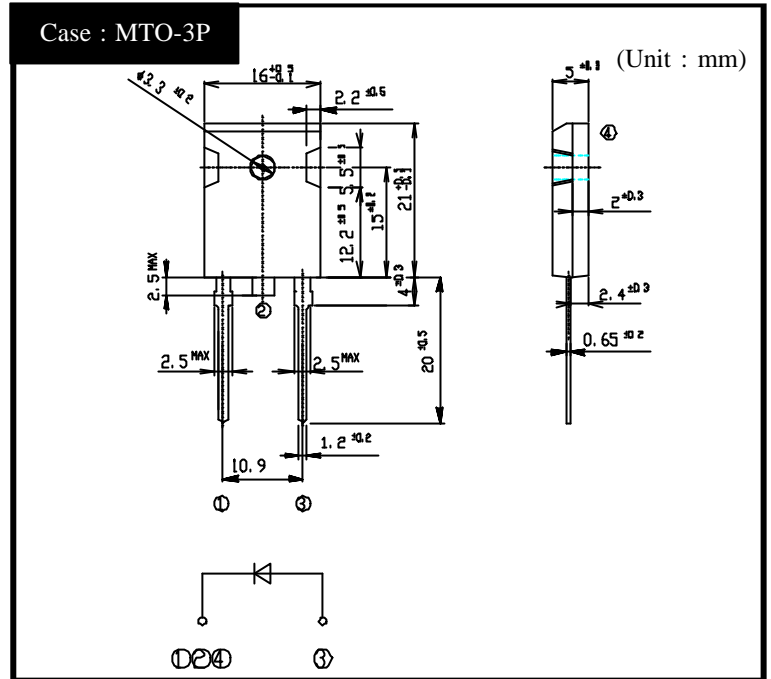

### RATINGS

Absolute Maximum Ratings (If not specified Tc=25 )

Item	Symbol	Conditions	Ratings	Unit
Storage Temperature	Tstg		-55 ~ 150	
Operating Junction Temperature	Tj		150	
Maximum Reverse Voltage	V <sub>RM</sub>		600	V
Average Rectified Forward Current	I <sub>O</sub>	50Hz sine wave, R-load, Tc=119	20	A
Peak Surge Forward Current	I <sub>FSM</sub>	50Hz sine wave, Non-repetitive 1 cycle peak value, Tj=25	400	A
Mounting Torque	TOR	(Recommended torque 0.5N·m)	0.8	N·m

Electrical Characteristics (If not specified Tc=25 )

Item	Symbol	Conditions	Ratings	Unit
Forward Voltage	V <sub>F</sub>	I <sub>F</sub> =20A, Pulse measurement	Max.1.5	V
Reverse Current	I <sub>R</sub>	V <sub>R</sub> =V <sub>RM</sub> , Pulse measurement	Max.25	μA
Reverse Recovery Time	trr	I <sub>F</sub> =0.5A, I <sub>R</sub> =1A	Max.100	ns
Thermal Resistance	jc	junction to case	Max.0.9	/W

# S20L60

# Forward Voltage

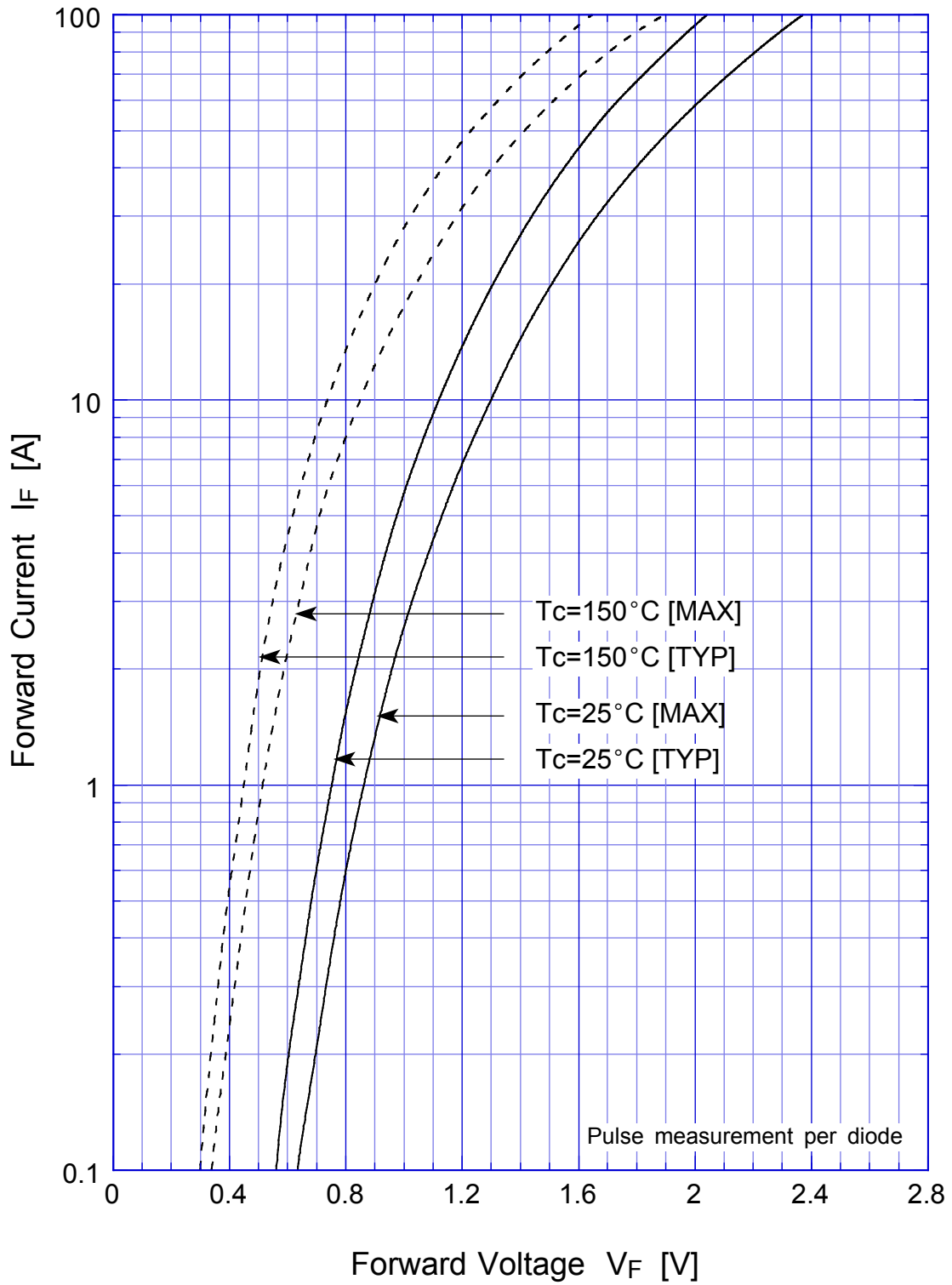

# S20L60

# Forward Power Dissipation

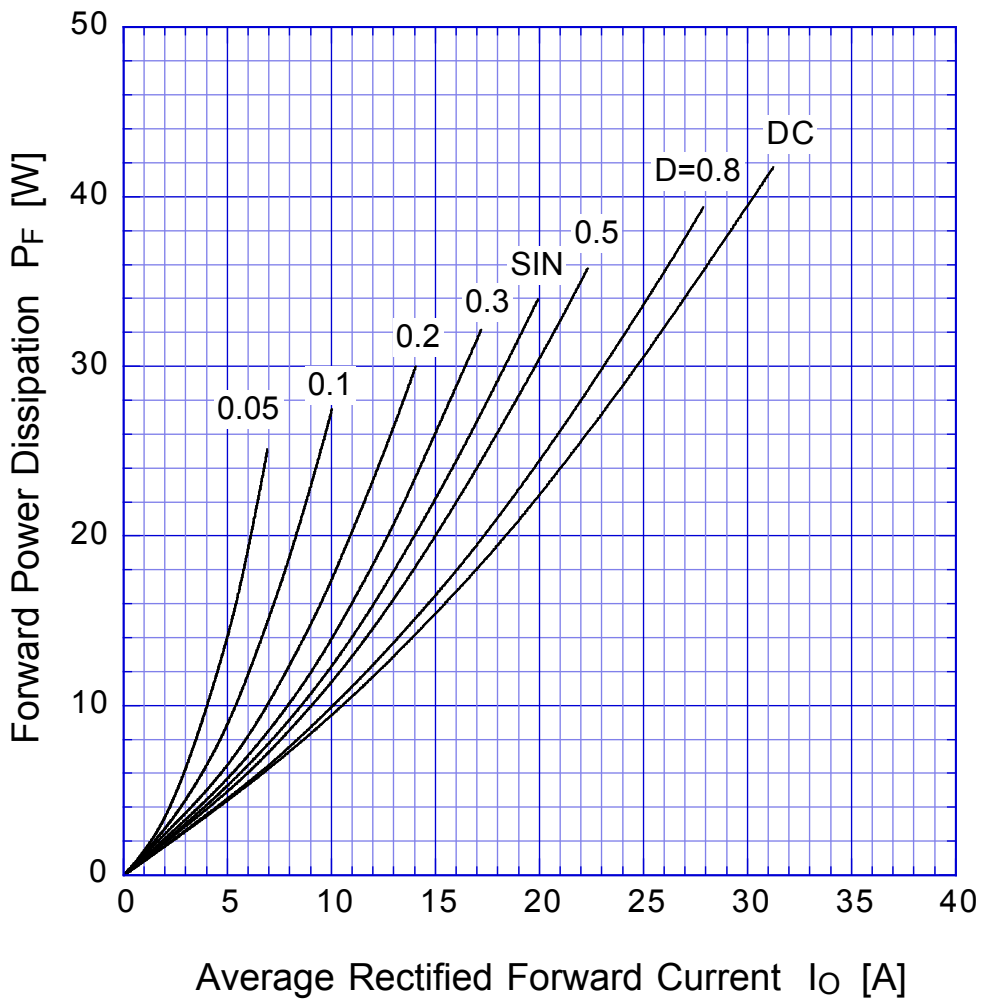

$T_j = T_{jmax}$

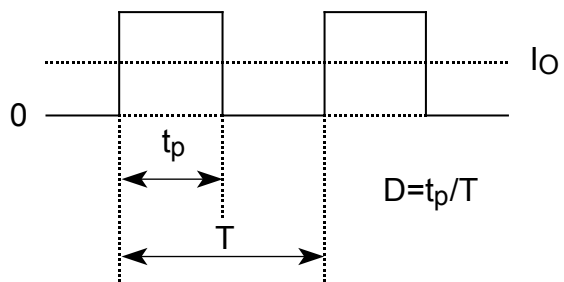

# S20L60

# Derating Curve

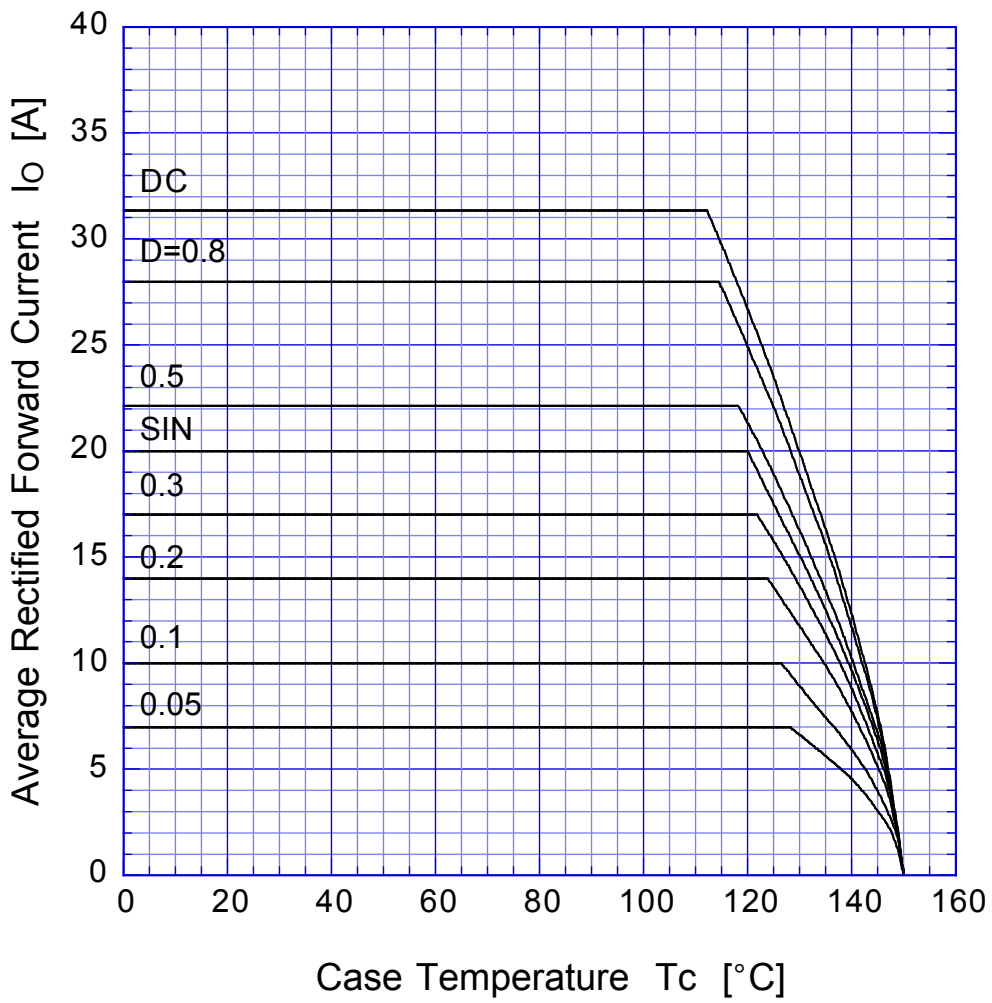

$$V_R = V_{RM}$$

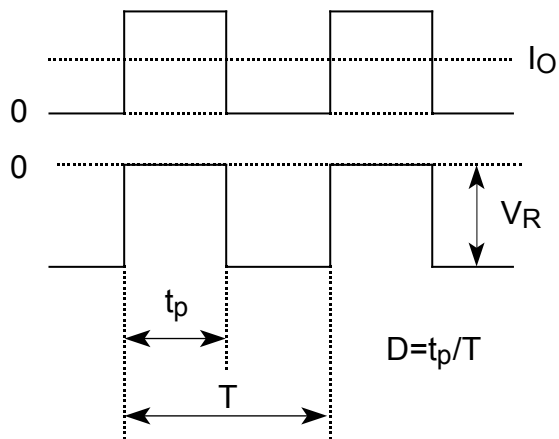

# S20L60

## Peak Surge Forward Capability

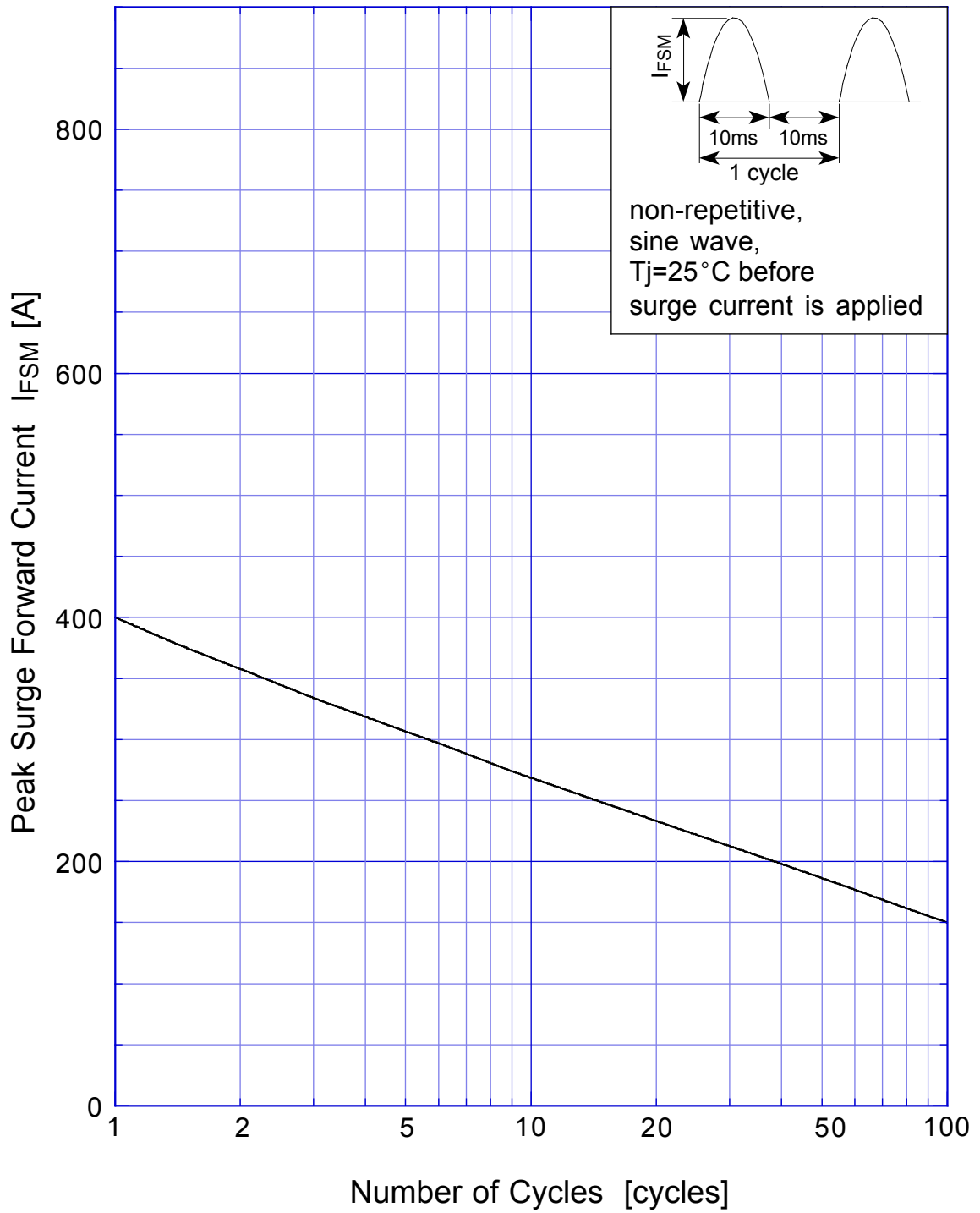

# S20L60 Junction Capacitance

