



EVERLIGHT ELECTRONICS CO.,LTD.

Device Number : DLE-038-159 REV: 1.0

T-1 3/4(5mm) High Intensity LEDs

MODEL NO : 383-2SDRC/S530-A5 ECN : _____ Page: 1/4

Features :

- Popular T-1 3/4 diameter package.
- Choice of various viewing angles.
- Available on tape and reel.
- Reliable and robust.

Description :

- The series is specially designs for applications require higher brightness than that achievable with standard lamp.
- The LED lamps are available with different colors,intensities, epoxy colors, etc.

Package Dimension:

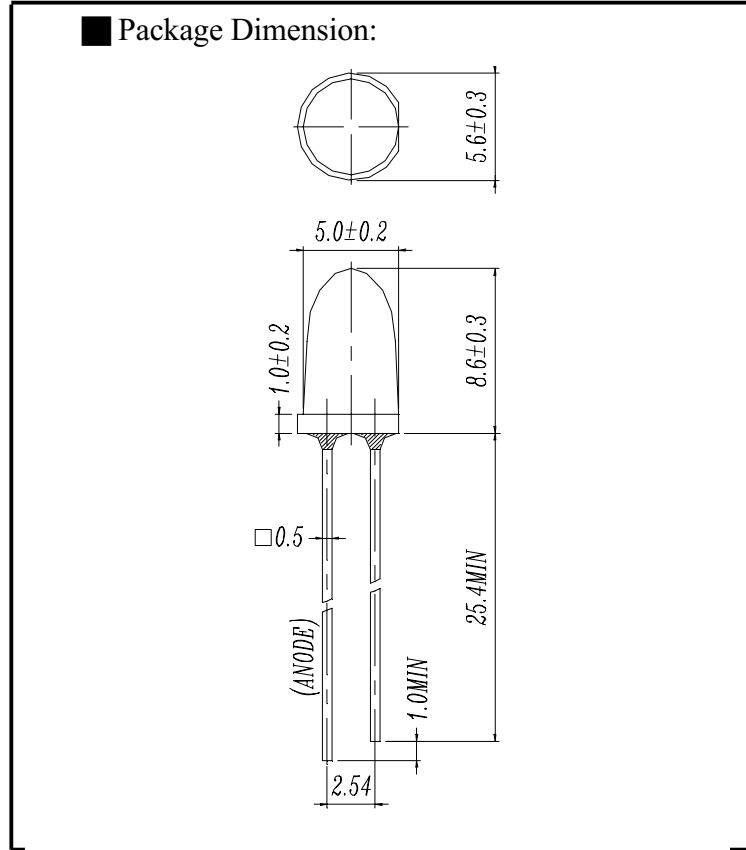

Applications :

- TV Set
- Monitor
- Telephone
- Computer

NOTES :

- 1.All dimensions are in millimeter.
- 2.An epoxy meniscus may extend about 1.5mm(0.059") down to the lead.

PART NO	CHIP		Lens Color
	Material	Emitted Color	
383-2SDRC/S530-A5	AlGaInP	Super Deep-Red	Water Clear

DESIGNER	CHECKER	APPROVER

Office : NO 25,Lane 76,Chung Yang Rd,Sec.3
Tucheng,Taipei 236,Taiwan,R.O.C.

TEL : 886-2-2267-2000,2267-9936(22 Lines)
FAX : 886-2-2267-6189



EVERLIGHT ELECTRONICS CO.,LTD.

Device Number : DLE-038-159 REV: 1.0

T-1 3/4 (5mm) Round Shape LEDs

MODEL NO : 383-2SDRC/S530-A5 ECN : _____ Page: 2/4

■ Absolute Maximum Ratings at Ta = 25°C

Parameter	Symbol	Rating	Unit
Forward Current	If	25	mA
Operating Temperature	Topr	-40 to +85	°C
Storage Temperature	Tstg	-40 to +100	°C
Soldering Temperature	Tsol	260 ± 5	°C
Electrostatic Discharge :	ESD	2000	V
Power Dissipation	Pd	60	mW
Peak Forward Current(Duty 1/10 @ 1KHZ)	If(Peak)	160	mA
Reverse voltage	Vr	5	V

■ Electronic Optical Characteristics :

Parameter	Symbol	MIN.	TYP.	MAX.	Unit	Condition
Luminous intensity	Iv	---- 2590	209 3490	-----	mcd	If=2mA If=20mA
Viewing Angle	2 θ 1/2	----	6	----	deg	If=20mA
Peak Wavelength	λ p	----	650	-----	nm	If=20mA
Dominant Wavelength	λ d	----	639	----	nm	If=20mA
Spectrum Radiation Bandwidth	△ λ	---	20	----	nm	If=20mA
Forward Voltage	Vf	----	2.0	2.4	V	If=20mA
Reverse Current	Ir	----	----	10	μ A	Vr=5V



Device Number : DLE-038-159 REV: 1.0

T-1 3/4(5mm) High Intensity LEDs

MODEL NO 383-2SDRC/S530-A5 ECN : _____ Page: 3/4

■ Typical Electro-Optical Characteristic Curves

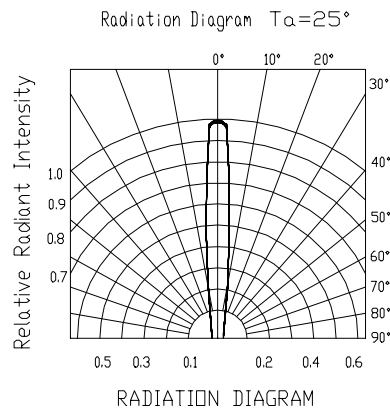
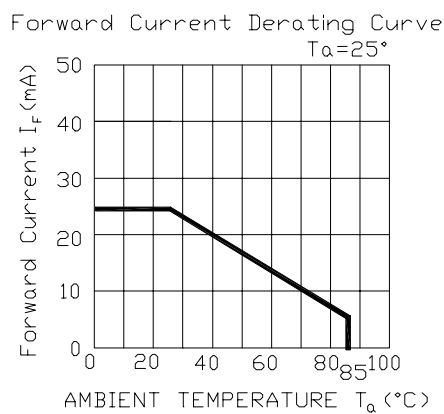
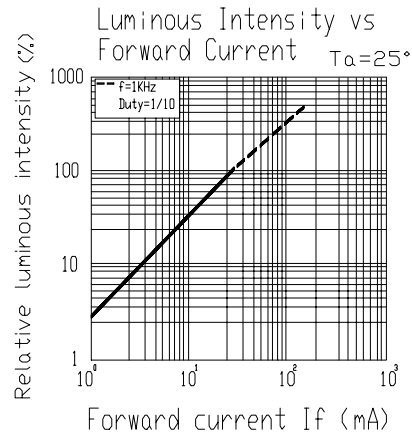
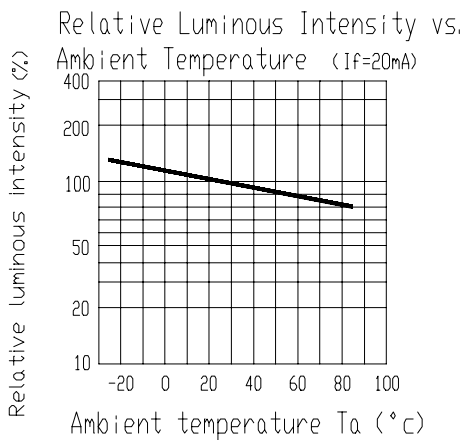
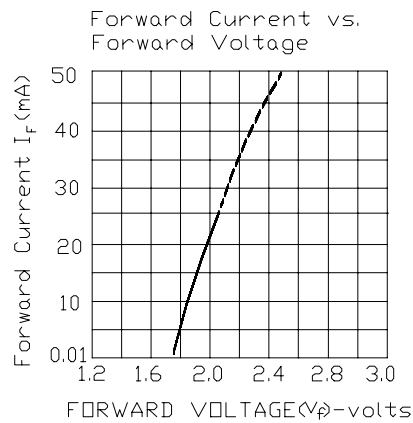
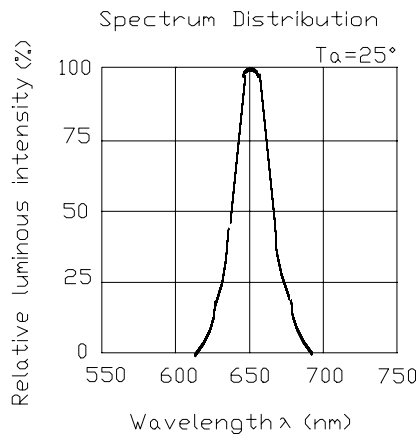



EVERLIGHT ELECTRONICS CO.,LTD.

Device Number : DLE-038-159

REV: 1.0

T-1 3/4 (5mm) Round Shape LEDs

MODEL NO 383-2SDRC/S530-A5

ECN :

Page: 4/4

■ Reliability test items and conditions

NO	Item	Test Conditions	Test Hours/Cycle	Sample Size	Ac/Re
1	Soldering Heat	TEMP : 260°C ± 5 °C	5 SEC	76 Pcs	0/1
2	Temperature Cycle	H : +85°C 30min ∫ 5 min L : -55°C 30min	50 CYCLE	76 Pcs	0/1
3	Thermal Shock	H : +100°C 5min ∫ 10 sec L : -10°C 5min	50 CYCLE	76 Pcs	0/1
4	High Temperature Storage	TEMP : 100°C	1000 HRS	76 Pcs	0/1
5	Low Temperature Storage	TEMP : -55°C	1000 HRS	76 Pcs	0/1
6	DC Operating Life	If = 20 mA	1000 HRS	76 Pcs	0/1
7	High Temperature / High Humidity	85°C/85% RH	1000 HRS	76 Pcs	0/1